

# BioAdmin Manual

## Version 4.3

BioAdmin™, BioEntry™, BEACon™ and BioStation™ are registered as trademarks of Suprema Inc. All rights reserved. No part of this work covered by the copyright hereon may be reproduced or copied by any means – graphics, electronic or mechanical methods, including photocopying, recording, taping, or information and retrieval systems – without written permission of Suprema Inc. Any software furnished under a license may be used or copied only in accordance with its terms.

Suprema Inc reserves the right to modify or revise all or any part of this document without notice and shall not be responsible for any loss, cost or damage, including consequential damage, caused by reliance on these materials.



## Suprema Warranty Policy

Suprema warrants to buyer, subject to the limitations set forth below, that each product shall operate in substantial accordance with the published specifications for such product for a period of one (1) year from the date of shipment of the products ("Warranty Period"). If buyer notifies Suprema in writing within the Warranty Period of any defects covered by this warranty, Suprema shall, at its option, repair or replace the defective product which is returned to Suprema within Warranty Period, freight and insurance prepaid by buyer. Such repair or replacement shall be Suprema's exclusive remedy for breach of warranty with respect to the Product. This limited warranty shall not extend to any product which has been: (i) subject to unusual physical or electrical stress, misuse, neglect, accident or abuse, or damaged by any other external causes; (ii) improperly repaired, altered or modified in any way unless such modification is approved in writing by the Supplier; (iii) improperly installed or used in violation of instructions furnished by Suprema.

Suprema shall be notified in writing of defects in the RMA report supplied by Suprema not later than thirty days after such defects have appeared and at the latest one year after the date of shipment of the Products. The report should give full details of each defected product, model number, invoice number and serial number. No product without RMA (Return Material Authorization) number issued by Suprema may be accepted and all defects must be reproducible for warranty service.

Except as expressly provided herein, the products are provided "as is" without warranty of any kind, either express or implied, including, but not limited to, warranties or merchantability, fitness for a particular purpose.

## Disclaimers

The information in this document is provided in connection with Suprema products. No license, express or implied, by estoppels or otherwise, to any intellectual property rights is granted by this document. Except as provided in Suprema's Terms and Conditions of Sale for such products,

Suprema assumes no liability whatsoever, and Suprema disclaims any express or implied warranty, relating to sale and/or use of Suprema products including liability or warranties relating to fitness for a particular purpose, merchantability, or infringement of any patent, copyright or other intellectual property right.

Suprema products are not intended for use in medical, life saving, life sustaining applications, or other applications in which the failure of the Suprema product could create a situation where personal injury or death may occur. Should Buyer purchase or use Suprema products for any such unintended or unauthorized application, Buyer shall indemnify and hold Suprema and its officers, employees, subsidiaries, affiliates, and distributors harmless against all claims, costs, damages, and expenses, and reasonable attorney fees arising out of, directly or indirectly, any claim of personal injury or death associated with such unintended or unauthorized use, even if such claim alleges that Suprema was negligent regarding the design or manufacture of the part.

Suprema reserves the right to make changes to specifications and product descriptions at any time without notice to improve reliability, function, or design. Designers must not rely on the absence or characteristics of any features or instructions marked "reserved" or "undefined." Suprema reserves these for future definition and shall have no responsibility whatsoever for conflicts or incompatibilities arising from future changes to them.

Please contact Suprema, local Suprema sales representatives or local distributors to obtain the latest specifications and before placing your

product order.

Note: Third-party brands and names are the property of their respective owners.

## About BioEntry and BioStation

BioEntry and BioStation are biometric access control and time attendance device with algorithms awarded 2<sup>nd</sup> consecutive grand prix at finger scan contest (FVC2004 & FVC2006) and standard Wiegand interface. BioEntry and BioStation can replace an existing system or be added to an existing access control and time attendance system with ease.

BioEntry Smart is a fingerprint smart card device that seamlessly integrates fingerprint and smart card device into one device. BioEntry™ Smart is designed to replace existing access devices like proximity or magnetic devices without additional wiring. Fingerprint template is stored in each user's smart card and there is no need to store fingerprint data in a device itself. This eliminates the burden of template management and networking devices.

BioEntry Pass is a fingerprint access device equipped with fast one to many fingerprint identification engines. Enrolled with more than hundreds of users, identification can be done in less than one second.

BioStation is the access control and time attendance finger terminal of distinguished performance. Multifunctional fingerprint terminal for access control and time and attendance, BioStation provides various information real time adopting 2.5 inch color LCD and high-quality sound. Also, using wireless LAN or USB memory, you can configure network and transfer data without complicated wiring.

BioEntry and BioStation supports various fingerprint sensors, i.e. Optical, semiconductor type (capacitive type) or scan type (swipe thermal type),

enabling a user to utilize an optimum fingerprint sensor fit for the application system.

## About Suprema Inc

Suprema is a leading biometric company offering core fingerprint technologies in various applications. Suprema's fingerprint products include access control systems, time attendance system, low cost standalone OEM modules, USB fingerprint scanners and fingerprint algorithm SDK. Suprema's fingerprint recognition algorithm was proved to be the world top level by ranking first in the 3rd international Fingerprint Verification Competition (FVC2004 & FVC2006) with the lowest error rate in light category. Suprema's fingerprint products have been sold to more than 80 different countries and are being used in various applications.

For more information on Suprema's technologies and products, please visit Suprema's website (<http://www.supremainc.com>) or contact by e-mail ([sales@supremainc.com](mailto:sales@supremainc.com)).

## About This Manual

This is an introduction to operation of BioEntry, BioEntry Plus, and BioStation. This manual describes how to manage templates, properly adjust relevant parameters, enroll or delete templates, etc. The purpose of this manual is to provide instructions to using BioEntry and BioStation and troubleshooting tips.

## Table of contents

Table of contents .....	6
1. Getting Started .....	16
1.1. Outline .....	16
1.2. Fundamentals .....	16
1.2.1. Finger scan device .....	16
1.2.2. Finger scan smart card device .....	16
1.2.3. Template .....	17
1.2.4. Enrollment .....	17
1.2.5. Verification .....	17
1.2.6. Identification .....	17
1.2.7. User database .....	17
1.2.8. Transfer .....	18
1.2.9. Site key for smartcard .....	18
1.3. How to place a finger .....	18
1.3.1. Select a finger to enroll .....	18
1.3.2. How to place a finger on a sensor .....	18
1.3.3. Tips for different finger conditions .....	19
1.3.4. Advices on fingerprint enrollment .....	19
1.4. Concept of BioAdmin 4.3 .....	19
1.4.1. How to install BioAdmin Server .....	20
1.4.2. How to install BioAdmin Client .....	32
1.4.3. Using MySQL or SQL Server database .....	34
1.4.4. Check the BioAdmin software installation .....	45
1.5. Log in to BioAdmin .....	48
1.5.1. Connect Server .....	48
1.5.2. Registering the initial system administrator account .....	48
1.5.3. Log in to the BioAdmin 4.3 .....	49
1.6. User Level on BioAdmin 4.3 .....	50

1.7.	BioAdmin configuration .....	50
1.7.1.	Command Menu bar .....	51
1.7.2.	Main menu.....	52
1.7.3.	Task and Utilities.....	52
1.7.4.	Main window.....	52
1.8.	User Database .....	52
2.	Options to determine before starting .....	53
2.1.	Security Option.....	53
2.2.	Template Format Option.....	53
2.3.	Access Control Option.....	53
2.4.	Using Mifare Card.....	53
3.	Quick start.....	55
3.1.	Quick start with BioStation .....	55
3.1.1.	Step 1 : HW installation.....	55
3.1.2.	Step 2 : Search new device.....	55
3.1.3.	Step 3: Connect device.....	59
3.1.4.	Step 4: User management .....	63
3.1.5.	Step 5: Issue Mifare card.....	73
3.1.6.	Step 6 : Rules on user T&A event control .....	75
3.1.7.	Step 7 : Enroll user with 'transfer checked user to device' menu .....	76
3.1.8.	Step 8: Monitoring .....	77
3.1.9.	Step 9: Log List.....	78
3.1.10.	Step 10: Report .....	78
3.2.	Quick start with BioEntry Plus .....	79
3.2.1.	Step 1 : Hardware Installation .....	79
3.2.2.	Step 2 : Search a New Device .....	79
3.2.3.	Step 3 : Connect a New Device .....	80
3.2.4.	Step 4 : User Management .....	81
3.2.5.	Step 5: Issue Mifare card.....	89
3.2.6.	Step 6 : User Time Attendance Rule .....	92

3.2.7. Step 7 : User registration with “Transfer Checked Users to Device” menu .....	93
3.2.8. Step 8 : Monitoring .....	94
3.2.9. Step 9 : Log List.....	96
3.2.10. Step 10 : Reports.....	97
3.3. Quick start with BioLite Net .....	97
3.3.1. Step 1 : Hardware Installation .....	97
3.3.2. Step 2 : Search a New Device .....	97
3.3.3. Step 3 : Connect a New Device .....	98
3.3.4. Step 4 : User Management .....	99
3.3.5. Step 5: Issue Mifare card.....	107
3.3.6. Step 6 : User Time Attendance Rule .....	110
3.3.7. Step 7 : User registration with “Transfer Checked Users to Device” menu .....	111
3.3.8. Step 8 : Monitoring .....	112
3.3.9. Step 9 : Log List.....	114
3.3.10. Step 10 : Reports.....	115
3.4. Quick start with BioEntry Smart .....	115
3.4.1. Step 1: Hardware installation.....	115
3.4.2. Step 2: Enroll user .....	116
3.4.3. Step 3: Issuing user smart card .....	123
3.4.4. Step 4: Enroll user ID in the external controller.....	125
3.4.5. Step 5: Authentication Test .....	125
3.5. Quick start with BioEntry Pass .....	126
3.5.1. Step 1: Hardware installation.....	126
3.5.2. Step 2: Search new device.....	126
3.5.3. Step 3: Enroll user .....	129
3.5.4. Step 4: Enroll user with ‘transfer checked user to device’ menu.....	137
3.5.5. Step 5: Enroll user ID in the external controller.....	139
3.5.6. Step 6: Authentication test .....	139
3.5.7. Step 7: Monitoring .....	139
3.5.8. Step 8 : Check log .....	140



4.	User Management .....	141
4.1.	Configuration of user management page .....	141
4.2.	User List window.....	142
4.3.	User List Display Setting .....	142
4.4.	Search User .....	145
4.5.	Select user .....	145
4.6.	Add New User.....	146
4.6.1.	User information .....	146
4.6.2.	Custom field.....	148
4.6.3.	Fingerprint.....	150
4.6.4.	Issue user smart card .....	153
4.6.5.	Issue with PC USB smart card device .....	153
4.6.6.	Issue with BioEntry Smart .....	154
4.6.7.	User security level and all-time pass card (Bypass) setting .....	154
4.6.8.	Wiegand string setting using ID card.....	155
4.6.9.	Read issued smart card.....	156
4.6.10.	Card format.....	156
4.6.11.	Notes on card issue .....	156
4.6.12.	Rules on user T&A event control .....	157
4.7.	Delete checked user.....	157
4.7.1.	Delete checked user from BioAdmin software .....	157
4.7.2.	Synchronization deleted user information with device.....	157
4.8.	Transfer checked user to device.....	157
4.9.	Delete checked users from device .....	159
4.10.	Manage users in device .....	159
4.11.	Synchronize all users .....	161
4.12.	Export to file.....	161
4.13.	Import from file .....	163
5.	Device Management.....	166
5.1.	Search New device .....	167

---

5.1.1. Serial port.....	167
5.1.2. Ethernet.....	169
5.1.3. USB device.....	170
5.1.4. Virtual Terminal.....	170
5.1.5. UDP (BioEntry Plus / BioLite Net).....	172
5.2. Add New BEACon.....	176
5.3. Remove device.....	177
5.4. List Window.....	178
5.4.1. Device List.....	178
5.4.2. Zone List.....	179
5.5. Manage BioStation device.....	187
5.5.1. Device information.....	189
5.5.2. Operation mode.....	189
5.5.3. Network setting.....	194
5.5.4. Function key.....	199
5.5.5. Device Setting.....	200
5.5.6. Image & Sound.....	204
5.5.7. Notice.....	205
5.5.8. Wiegand.....	206
5.5.9. Door Setting.....	211
5.5.10. I/O Setting.....	213
5.5.11. Entrance Limit Setting.....	215
5.5.12. Black List.....	216
5.6. Manage Virtual Terminal.....	218
5.7. Manage BioEntry Plus device.....	219
5.7.1. Device information.....	219
5.7.2. Detect Device via UDP.....	219
5.7.3. Operation Mode.....	222
5.7.4. Network Setting.....	225
5.7.5. Entrance Limit Setting.....	226

---

5.7.6. Door Setting.....	228
5.7.7. I/O Setting.....	229
5.7.8. Command Card.....	231
5.7.9. Wiegand.....	232
5.7.10. Black List.....	236
5.8. Manage BioLite Net device.....	237
5.8.1. Device information.....	238
5.8.2. Detect Device via UDP.....	238
5.8.3. Operation Mode.....	240
5.8.4. Fingerprint Setting.....	243
5.8.5. Network Setting.....	244
5.8.6. T&A Event Setting.....	246
5.8.7. Entrance Limit Setting.....	248
5.8.8. Door Setting.....	249
5.8.9. I/O Setting.....	251
5.8.10. Wiegand.....	253
5.8.11. Black List.....	257
5.9. Manage BioEntry device.....	260
5.9.1. Device information.....	260
5.9.2. System Setting.....	261
5.9.3. I/O Setting.....	263
5.9.4. LED/Beep sound Setting.....	268
5.9.5. Wiegand Setting.....	270
5.9.6. Smart Card setting.....	275
5.10. BEACon Configuration.....	277
5.10.1. Operation Mode.....	278
5.10.2. Signaling speed (Baud rate).....	278
5.10.3. BEACon Relay Setting.....	278
5.10.4. Switch Setting.....	280
5.10.5. Refresh / Apply / Transfer (apply to another device).....	282

6.	Smartcard / Mifare card .....	283
6.1.	Configuration of Smartcard page.....	283
6.2.	Smartcard List.....	284
6.3.	Card issue .....	284
6.4.	Configure Smartcard .....	285
6.4.1.	Read issued smart card.....	286
6.4.2.	Smart card format .....	286
6.5.	Edit Card Layout .....	286
6.5.1.	Select Device Type for Smart card / Mifare card.....	287
6.5.2.	Configuration of smartcard layout edit page (BioEntry Smart Only).....	287
6.5.3.	Size of Fingerprint data (Template).....	288
6.5.4.	Block.....	289
6.5.5.	Editing process .....	289
6.5.6.	Factory default (initial setting) layout.....	290
6.5.7.	Configuration of Mifare card layout edit page (BioStation / BioEntry Plus) .....	291
6.5.8.	Editing process .....	291
7.	Access Control .....	293
7.1.	Time Code setting.....	294
7.2.	Holiday setting.....	295
7.3.	Time zone setting.....	296
7.4.	Door Zone setting .....	297
7.5.	Access Group setting .....	298
8.	Monitoring.....	302
8.1.	Setup Monitoring.....	302
8.2.	Start Monitoring .....	303
8.3.	Pause Monitoring.....	304
8.4.	Event List for Door .....	304
8.4.1.	Door Open/Close .....	304
8.4.2.	Alarm Release.....	305

9.	Log List .....	306
9.1.	Configuration of Log check page.....	306
9.2.	Manage Log database .....	307
9.2.1.	Get recent logs .....	307
9.2.2.	Auto uploading setting .....	307
9.2.3.	Release auto uploading.....	309
9.2.4.	Upload all logs .....	310
9.2.5.	Export Report .....	311
9.2.6.	Delete Log information.....	312
10.	Reports .....	313
10.1.	Configuration of reports page.....	313
10.2.	Setup attendance rule .....	314
10.2.1.	Device setup .....	315
10.2.2.	Time setup .....	316
10.2.3.	BioStation function key setting .....	318
10.3.	Setup Monthly Schedule .....	319
10.4.	Group Configuration for T&A Control .....	319
10.4.1.	Use as default.....	321
10.5.	How to prepare report.....	321
10.6.	Edit Data.....	324
11.	Menu bar functions.....	327
11.1.	System.....	327
11.1.1.	Manage admin account.....	327
11.1.2.	Data backup.....	327
11.1.3.	Data recovery .....	327
11.1.4.	Lock all devices .....	327
11.1.5.	Unlock all devices.....	328
11.1.6.	Load BioAdmin 1.X data.....	328
11.1.7.	Preferences .....	328
11.1.8.	BioAdmin information.....	336

---

11.1.9. Reconnect Server .....	336
11.2. User Management.....	336
11.3. Device Management .....	337
11.3.1. Time setting.....	337
11.3.2. FW upgrade.....	338
11.3.3. Site Key Setting (BioEntry Smart).....	339
11.3.4. Site Key Setting ( Mifare ) .....	341
11.4. Access Control.....	342

## Revision History

<b>Version</b>	<b>Date</b>	<b>Description</b>
V1.0	2005.9.27	Created.
V1.1	2005.12.2	Incorporated the changes made by BioAdmin V1.1. Chapter 12. Site Key is added.
V2.0	2006.4.17	Incorporated the changes made by BioAdmin V2.0. Chapter 8. Access Control is added. Chapter 9. Monitoring is added.
V3.0	2006.8.23	Time Attendance added BioStation added.
V4.0	2007. 3. 5	Incorporated the changes made by BioAdmin V4.0.
V4.1	2007. 5. 30	Incorporated the changes made by BioAdmin V4.1.
V4.2	2007.10.19	Incorporated the changes made by BioAdmin V4.2. BioEntry Plus added.
V4.2.2	2008. 4. 27	Incorporated the change made by BioAdmin V4.2.2
V4.3	2008.12.10	Incorporated the changes made by BioAdmin V4.3 Chapter5. BioLite Net is added.

# 1. Getting Started

## 1.1. Outline

This manual illustrates how to use BioAdmin software. BioAdmin is a PC Windows software for the control and management of Suprema's BioEntry, BioStation and BEACon products. BioAdmin includes various functions needed for a host station for applications of access control and time & attendance using these devices.

For proper hardware connection, please refer to BioEntry Installation manual, BioStation Installation manual, and BioLite Net Installation manual.

There are two approaches in managing BioEntry, BioStation, and BioLite Net :

- Using BioAdmin program which is the management software running on Windows based PC platforms. This manual is mainly focused on operating BioEntry and BioStation using BioAdmin software.
- Integrating the management functionality into customer's application software using SDK which contains versatile API's to control BioEntry and BioStation. For further information, please refer to SFM SDK Reference Manual, BioStation SDK manual, and UniFinger Engine SDK Reference Manual.

## 1.2. Fundamentals

This chapter provides introductory information on BioEntry, BioStation, and BioAdmin including basic concepts, operation flow, and overview of the software.

### 1.2.1. Finger scan device

Fingerprint access device is a device to authenticate the identity of each person using fingerprints. It can be easily integrated into access control system by connecting with access control panel through industry standard interface such as Wiegand interface. Since fingerprints contain biometric features which are unique for each person, fingerprint access device can be substituted for existing access devices, such as barcode, magnetic card, keypad, or RF card devices, with high security and efficiency.

### 1.2.2. Finger scan smart card device

Fingerprint smart card device is an advanced model of fingerprint access device



which improves security of the system by integrating smart card technology. Fingerprint data for each person is stored on user's smart card and the device authenticates the user by comparing the stored fingerprint data in the smart card with the input fingerprint data.

### 1.2.3. Template

A template is the binary data representing the features of each fingerprint. The fingerprint image acquired from a fingerprint sensor is converted to a template, which is stored on the memory of the fingerprint access device or on user's smart card. In authenticating a user, a new template is also generated and compared with the stored templates.

### 1.2.4. Enrollment

Enrollment is the process to store the fingerprint template with user information. Through enrollment process, new users are entered into the system.

### 1.2.5. Verification

Verification is the process of authenticating an input fingerprint with the fingerprint of the specified user. On BioEntry Smart, a user places smart card containing personal fingerprint template and user information. Then, the device carries out verification process by scanning an input fingerprint. On BioEntry Pass, verification process can be implemented by connecting external Wiegand device, such as RF card device, which provides the current user ID.

### 1.2.6. Identification

Identification is the process of searching a matched fingerprint among the stored fingerprints on the device. BioEntry Pass and BioStation basically operate in identification mode, which requires no additional input except the placement of a finger.

### 1.2.7. User database

User database includes user ID, user name, fingerprint templates, and so on. BioAdmin software is based on the central management of user database. That is, the user database is created, updated, and stored on the host PC. Then, it is selectively distributed to the BioEntry and BioStation connected on the network using transfer menu.

### 1.2.8. Transfer

Transfer to Device is used to transfer the user database of the host PC to BioEntry and BioStation. The user information such as User ID, templates, access group, and security level is transferred by this process.

Detailed operations are as follows.

- Enroll new users on BioEntry and BioStation
- Replace inconsistent templates on BioEntry and BioStation
- Delete templates of unknown users or de-selected users on BioEntry and BioStation

Transfer from Device is used to upload the user formation from BioEntry and BioStation to the database of host PC. The user information such as User ID, Template Number, Number of Access Group, and Security Level can be uploaded by this process.

### 1.2.9. Site key for smartcard

Site key is a password for smart card to ensure that an authorized card should be used for a specific installation. 48 bit key is used in BioEntry Smart allowing 0 to 281374976710655 (0xFFFFFFFFFFFF). For proper operation, the same key should be configured on BioEntry Smart and user's smart card.

## 1.3. How to place a finger

### 1.3.1. Select a finger to enroll

- (1) It is recommended to use an index finger or a middle finger.
- (2) Thumb, ring or little finger is relatively more difficult to place in a correct position.

### 1.3.2. How to place a finger on a sensor

- (1) Place a finger as it completely covers the sensor with maximum contact.
- (2) It is better to place the core part of a fingerprint to the center of a sensor.
  - People usually tend to place only the top end of a finger
  - Where is the core (center) of a fingerprint?
    - A peak where spirals of fingerprint ridges are dense
    - Usually opposite to lower part of a nail
    - It is recommended to place a finger as the lower part of a nail is located at the center of a sensor

- (3) If a finger is placed as in the right picture, only a small area of a finger is captured. So it is recommended to place a finger as in the left picture.



### 1.3.3. Tips for different finger conditions

Suprema's fingerprint products are designed to scan fingerprint smoothly regardless of the conditions of a finger skin. However, if a fingerprint is difficult to scan due to other influences, please refer to the followings tips.

- (1) If a finger is stained with sweat or water, scan after wiping moisture off
- (2) If a finger is covered with dust or impurities, scan after wiping them off
- (3) If a finger is way too dry, scan after blowing warm breath on a fingertip.

### 1.3.4. Advices on fingerprint enrollment

- (1) In fingerprint recognition, enrollment process is very important. Therefore, when enrolling a fingerprint, please try to place a finger correctly with care.
- (2) In case of low acceptance ratio, the following actions are recommended.
  - Delete enrolled fingerprints and re-enroll the fingers.
  - Enroll the same finger additionally
  - Try with another finger if a finger is not easy to enroll due to scar or worn-out.
- (3) For the case when an enrolled fingerprint can't be used due to scar or holding a baggage, it is recommended to enroll more than two fingers.

## 1.4. Concept of BioAdmin 4.3

BioAdmin 4.3 is operated as server-client application so that users can operate the BioAdmin Client program from multiple host PCs at the same time. If the users connect BioStation to the BioAdmin Server, logs from the BioStation will be automatically stored on the database of BioAdmin Server real-time. In this server-client application, BioAdmin Client is used as the user interface to manage the data.

If the user does not connect the BioStation to the BioAdmin Server, logs will not be

stored on the database automatically.

BioAdmin Server is designed only for BioStation. Therefore, you cannot use the BioEntry or BEACon as the server-client application.

This chapter describes the installation and operation of BioAdmin Server and BioAdmin Client programs.

#### 1.4.1. How to install BioAdmin Server

- Select the PC to be used as the server. Server PC should be always tuned on , because it should receive log data from the connected BioStation and store it on the database real time.
- After selecting a PC to use as the BioAdmin Server, install the BioAdmin Server program. This chapter shows the installation process under the condition that you are using the database on your host PC. If you are using MySQL or SQL Server, you can refer to the chapter 1. 4. 3.
  
- Start Installation.

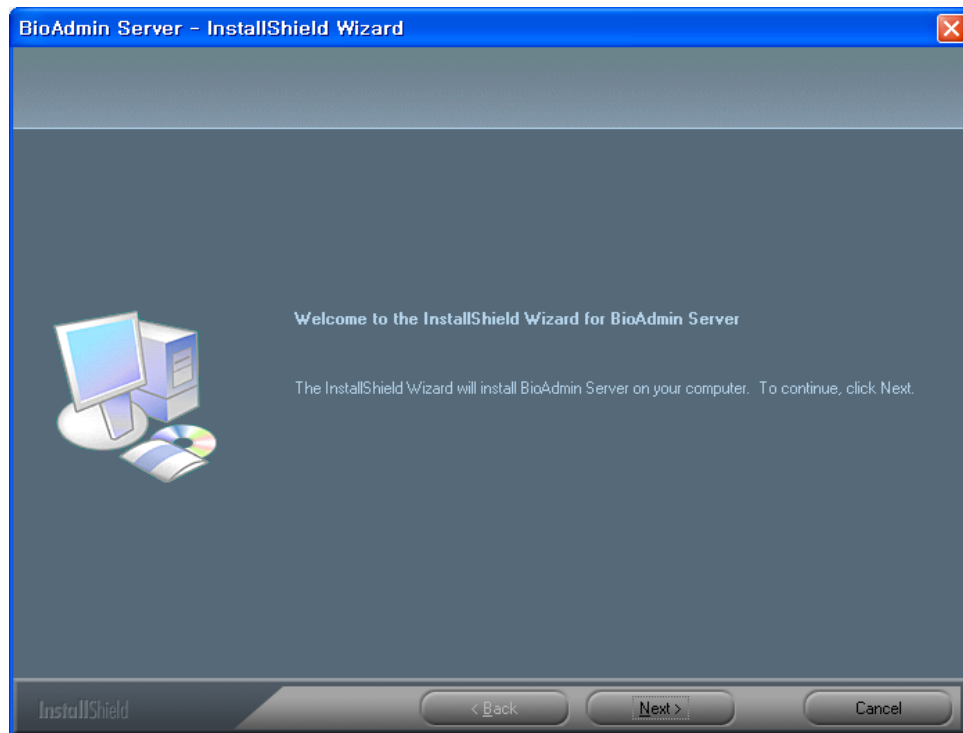

- Choose Destination Location

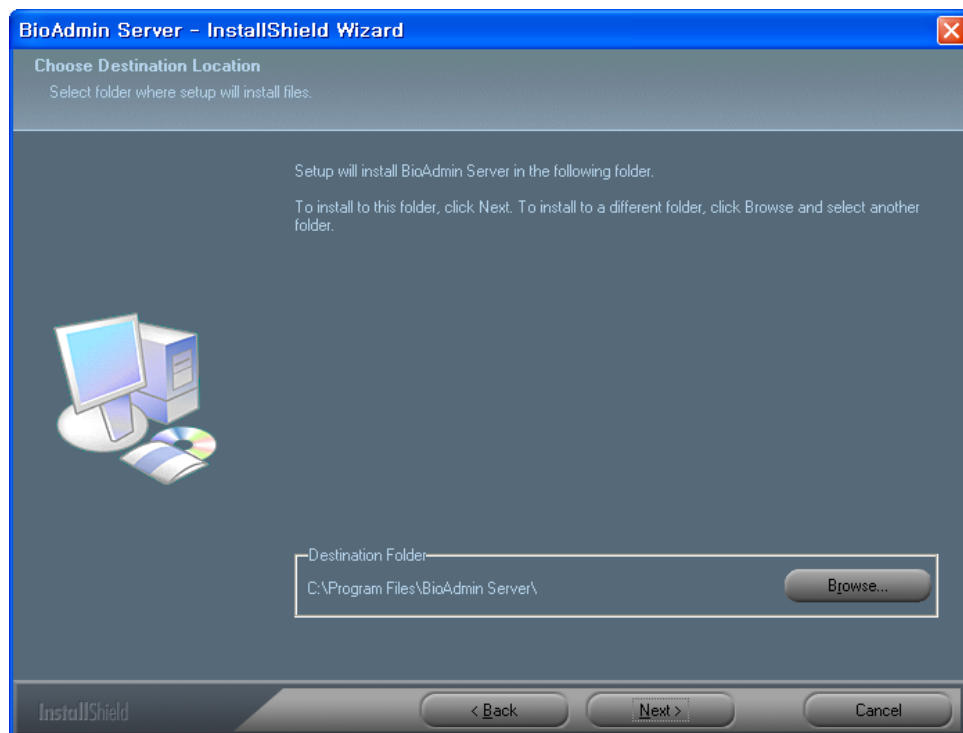

Choose the hard disk drive on which BioAdmin Server is to be installed. By

default, BioAdmin Server is installed in C:\Program Files\BioAdmin Server\.

- Setup Open SSL

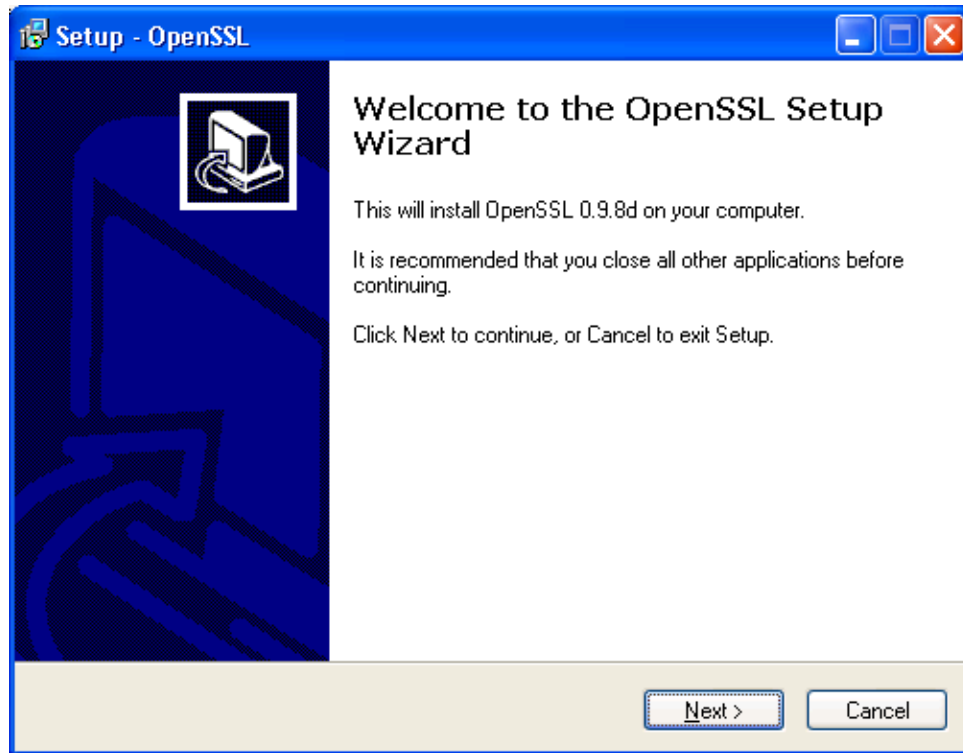

After copying all files, set up the Open SSL.

- BioAdmin Server Configuration and Database Setting

If you finish the Open SSL set up, following window will appear which is to set up the BioAdmin Server configuration. In most cases, you can maintain its default value for the BioAdmin Server configuration.

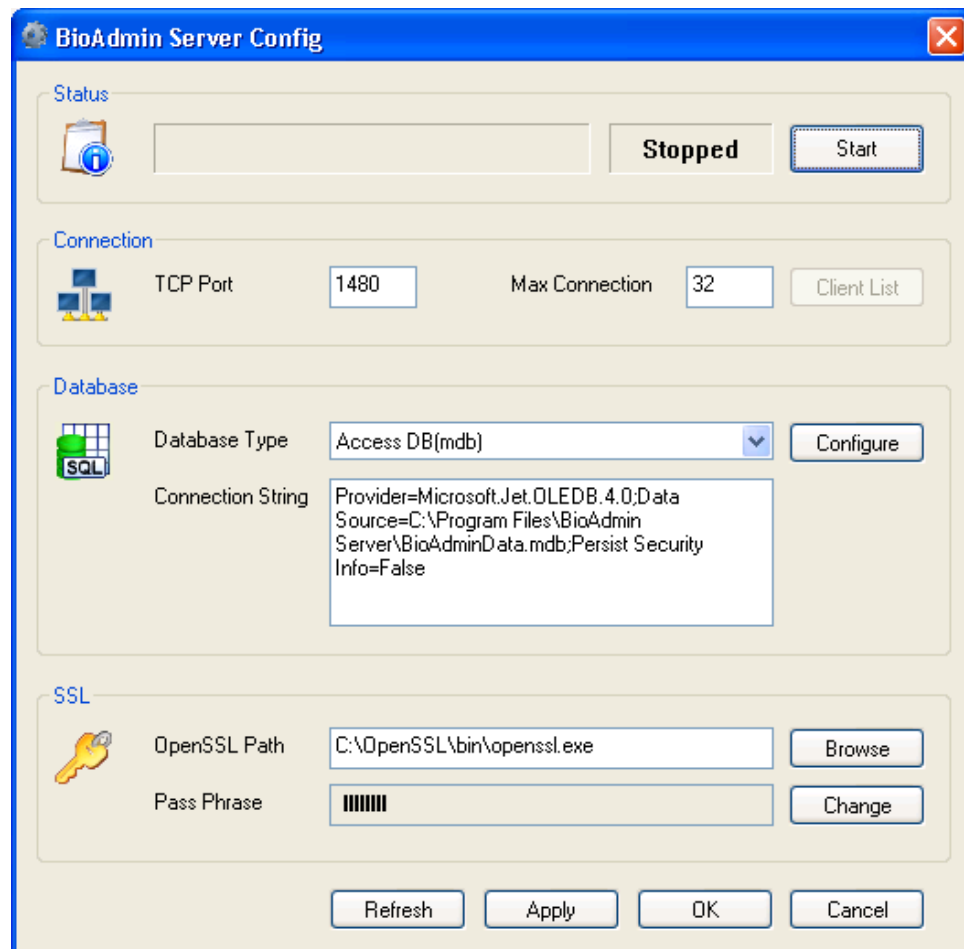

- Status

**Status** shows the current version and status of the BioAdmin Server. By pressing **Start** or **Stop** button, you can start or stop the operation of BioAdmin Server.

If BioAdmin Server is stopped, logs from the networked BioStation will not be stored on the database of the BioAdmin Server and BioAdmin Client will not be able to access to the BioAdmin Server.

If you changed any server configuration or database setting, stop the BioAdmin Server and restart it. Before you restart the BioAdmin Server, changes in the BioAdmin Server configuration or database will not be applied to the BioAdmin Server.

- Connection

On this menu, you can set up the networking details.

- TCP Port

Enter the TCP port. This TCP port is used when you attach a BioStation to the BioAdmin Server or when you access to the BioAdmin Server from BioAdmin Client. Use a unique port, which is not used by any other software.

In most cases, you can use the default port, 1480.

- Max Connection

Enter the maximum number of BioStation or BioAdmin Client, which can be connected to the BioAdmin Server at the same time. For example, if you designate it as 50, the total number of BioStation and BioAdmin Client, which can be connected to the BioAdmin Server simultaneously, will be 50.

Maximum number for this connection should be less than 128. If the number is less than 32, which is the default value, you do not need to lower this number from the default.

- Client List

Client List shows the list of BioStations, which are connected to the BioAdmin Server. This list shows the IP Address of those connected BioStations and indicates whether the SSL Certificate was issued. You can issue or remove the SSL Certificate on this list. If the BioAdmin Server is stopped, this menu will be deactivated.





After selecting the database type, press **Configure** button and set up the database. If you are using the default mdb file, select Microsoft Jet 4.0 OLE DB Provider.

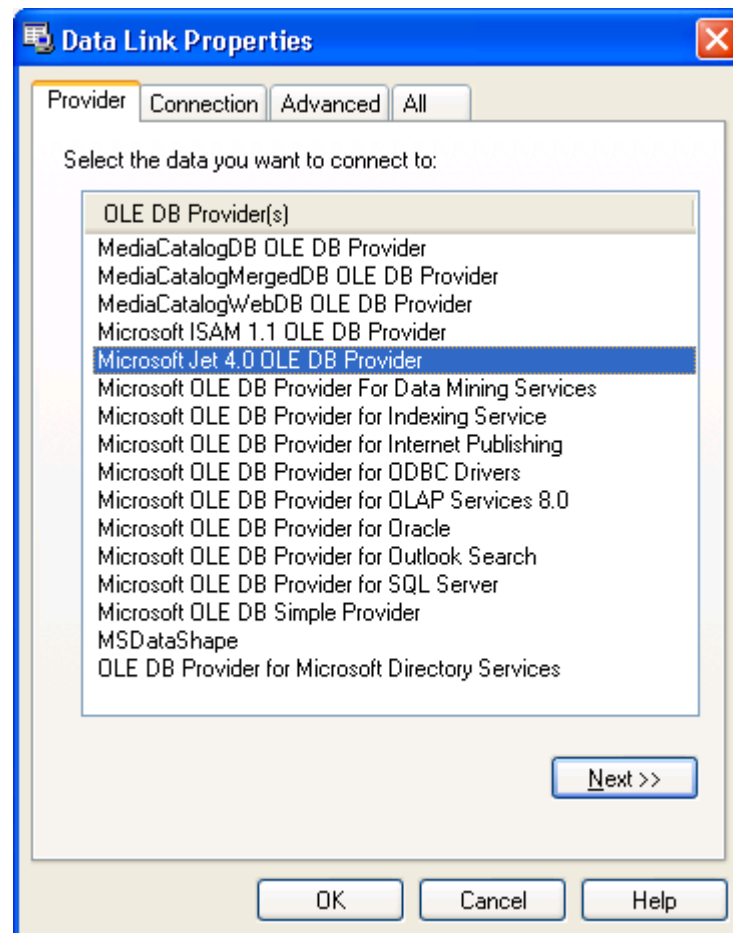

Press **Next** button.

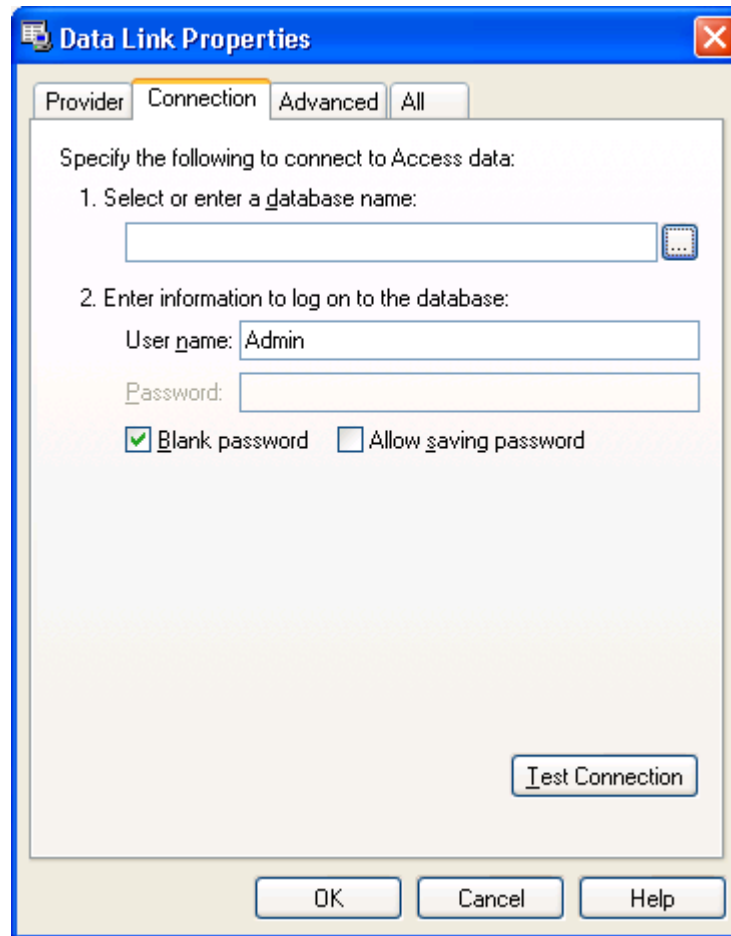

Select the Database file and press **OK** button.

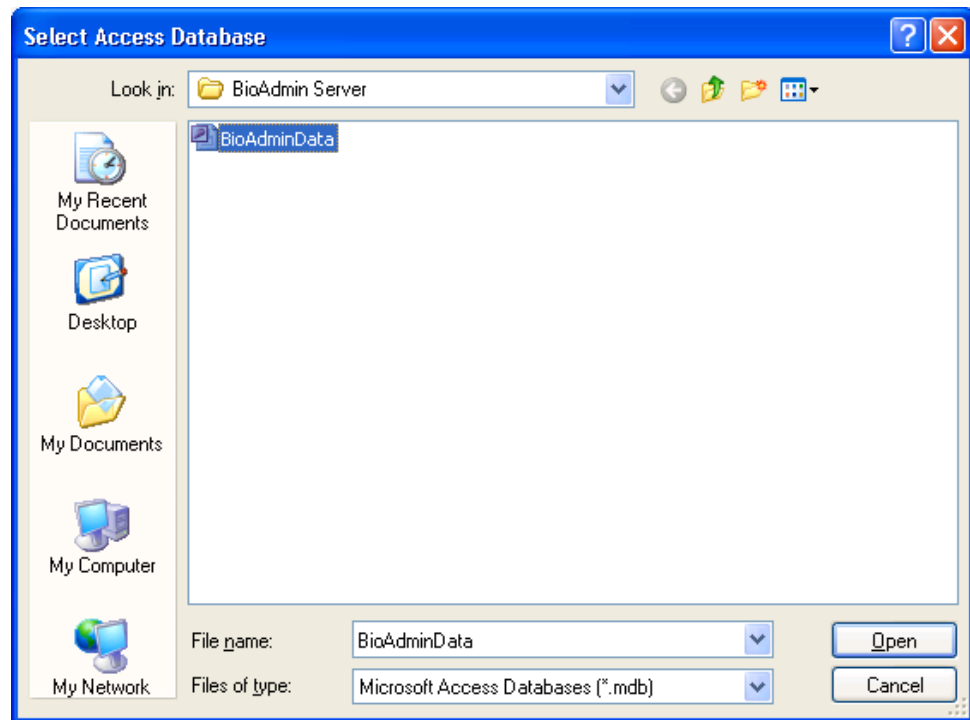

- **SSL**

Set up the encryption details between BioAdmin Server and BioAdmin Client or between BioAdmin Server and BioStation.

Press **Refresh** button to show the current setting.

Press **Apply** button to store the new setting. To apply the changes, you should stop and restart the BioAdmin Server.

Press **OK** button to store the new setting and close the BioAdmin Server Config window.

Press **Cancel** button to cancel the new setting and close the BioAdmin Server Config window.

- **OpenSSL Setting**
- BioAdmin Server uses a encrypted communication with BioAdmin Client and BioStation by using SSL authentication. Encrypting the communication between

BioAdmin Server and BioAdmin Client (or BioStation) enables much more secure solution to protect the information.

- Designate the OpenSSL path. By default, you can find the file on the following directory. If it is installed in any other directory, click the “Browse” and designate the correct directory.
- Default directory of the openssl.exe : (C:\OpenSSL\bin\openssl.exe)
- Pass Phrase is required to issue the certificate. You should enter more than 8 digits, combination of English, number, or special character. To make the system secure, you are strongly recommended to change the Pass Phrase upon the initial installation of BioAdmin Server.

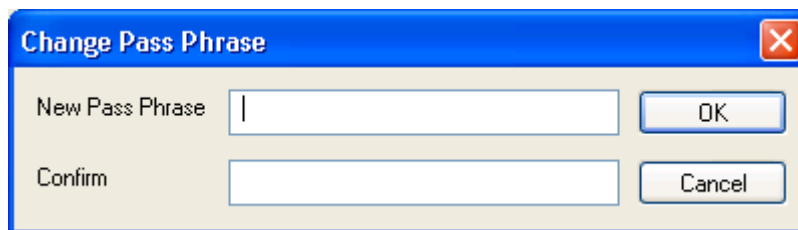

- If you change this Pass Phrase while using the BioAdmin Server after the installation, you should conduct the following procedures.
  - Change the SSL option of the connected BioStations as Not Use.
  - Stop the BioAdmin Server.
  - Change the Pass Phrase.
  - Start the BioAdmin Server.
  - Issue the SSL certificate for BioStation.  
If you are using BioAdmin Client, select the BioStation and press the right button of the mouse. Select **Authenticate Device**.
  - If the certificate is issued properly and stored on the BioStation, BioStation will restart automatically.
- DB Migration Tool
- If you were BioAdmin version 3.X, you need to convert the data from BioAdmin 3.1 to BioAdmin 4.X.
- If you do not need the old data, press Close button.

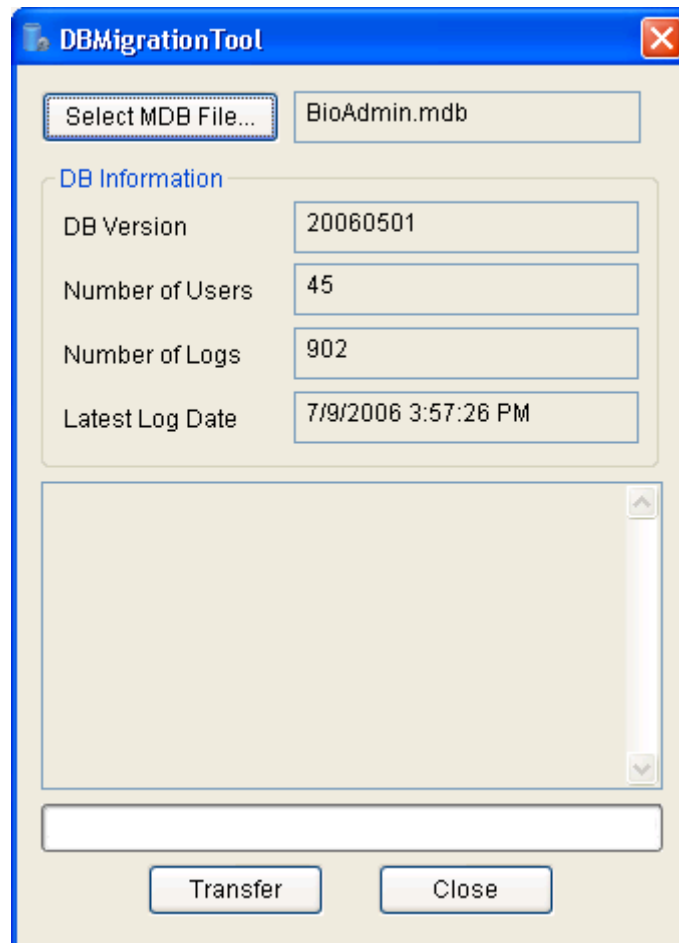

Select the old BioAdmin.mdb file.

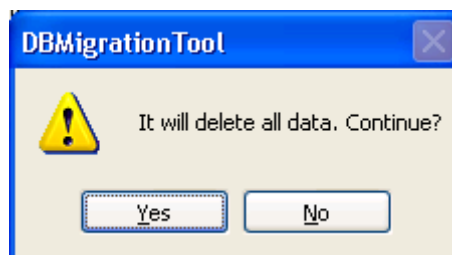

- Press Transfer button to transfer the old data to BioAdmin 4.X.
- If you transfer the old data, old data will be deleted. Therefore, if necessary, back up the old data before transferring to BioAdmin 4.X. This data transfer may take time depending on the size of the existing database.

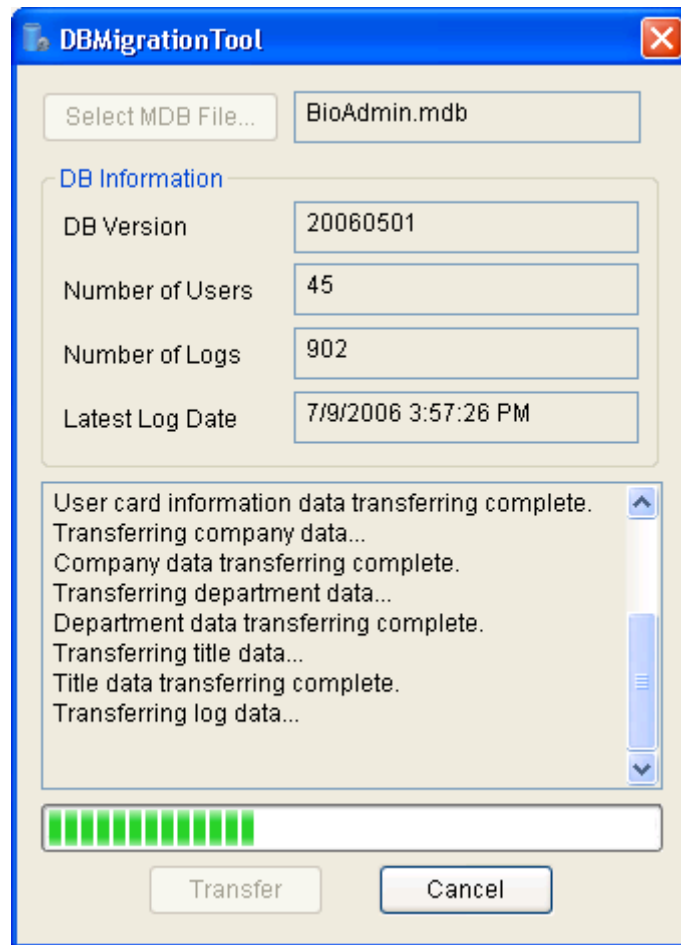

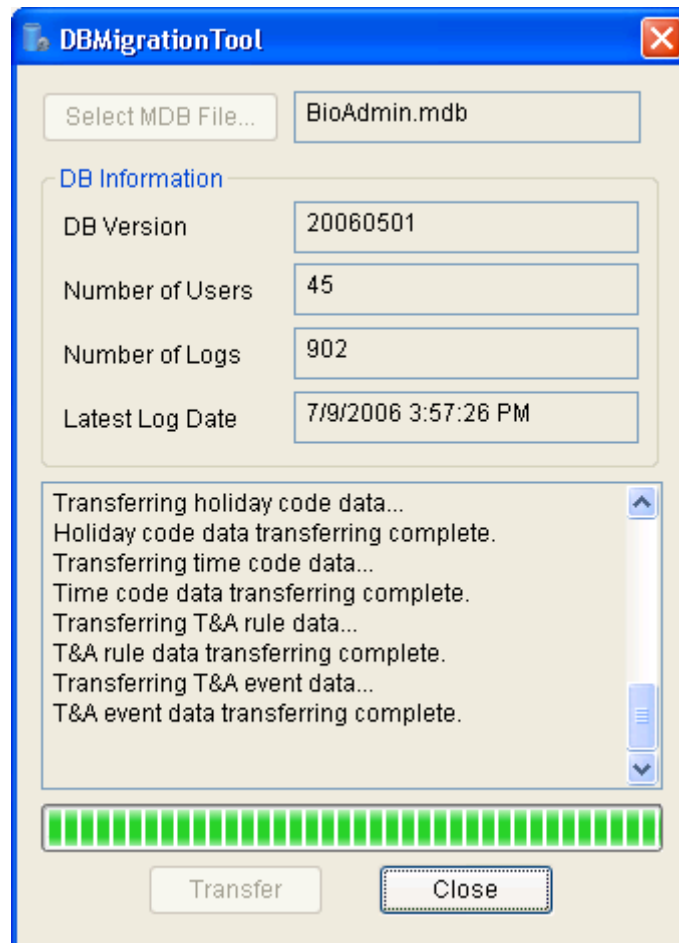

- After the transfer, press Close button.
- Installation Complete
- BioAdmin Server was successfully installed. If you are using the OS Windows 2000 or XP, BioAdmin Server will start as its background service. After this initial installation, BioAdmin Server will run automatically.

#### 1.4.2. How to install BioAdmin Client

- Start Installation.



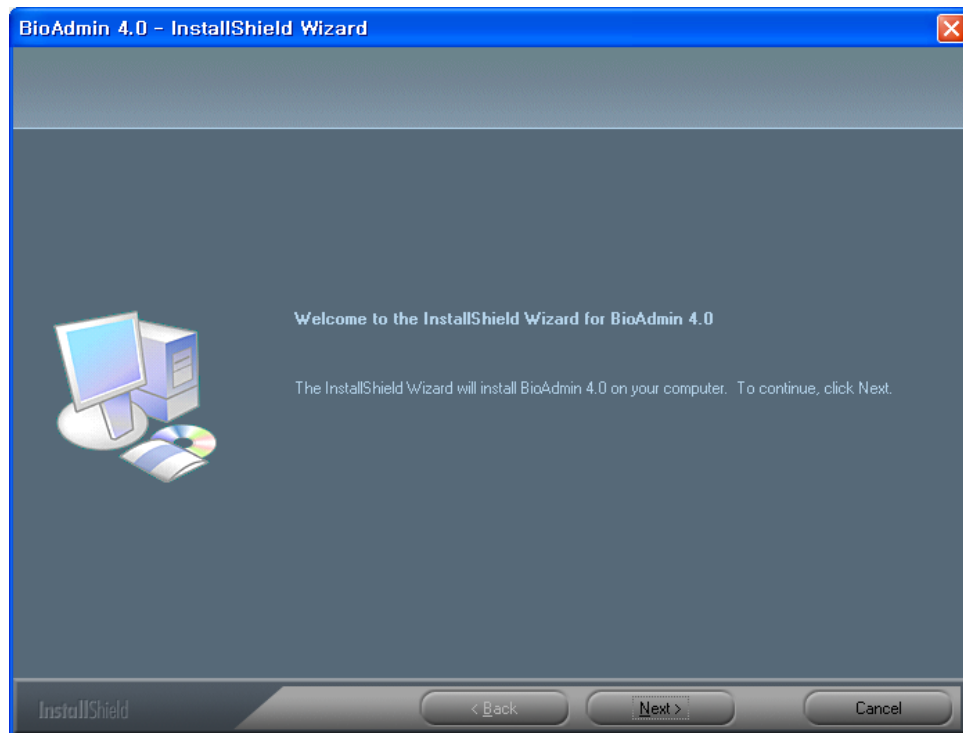

- Choose Destination Location

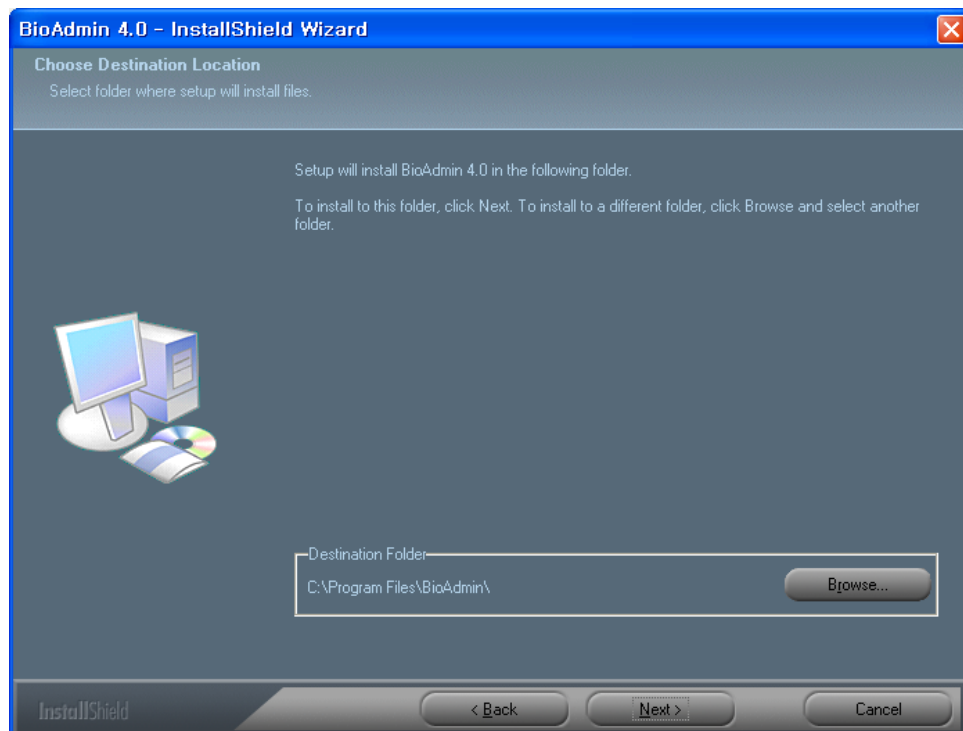

Choose the hard disk drive on which BioAdmin Client is to be installed. By default, BioAdmin Client is installed in C:\Program Files\BioAdmin.

- Installation Complete

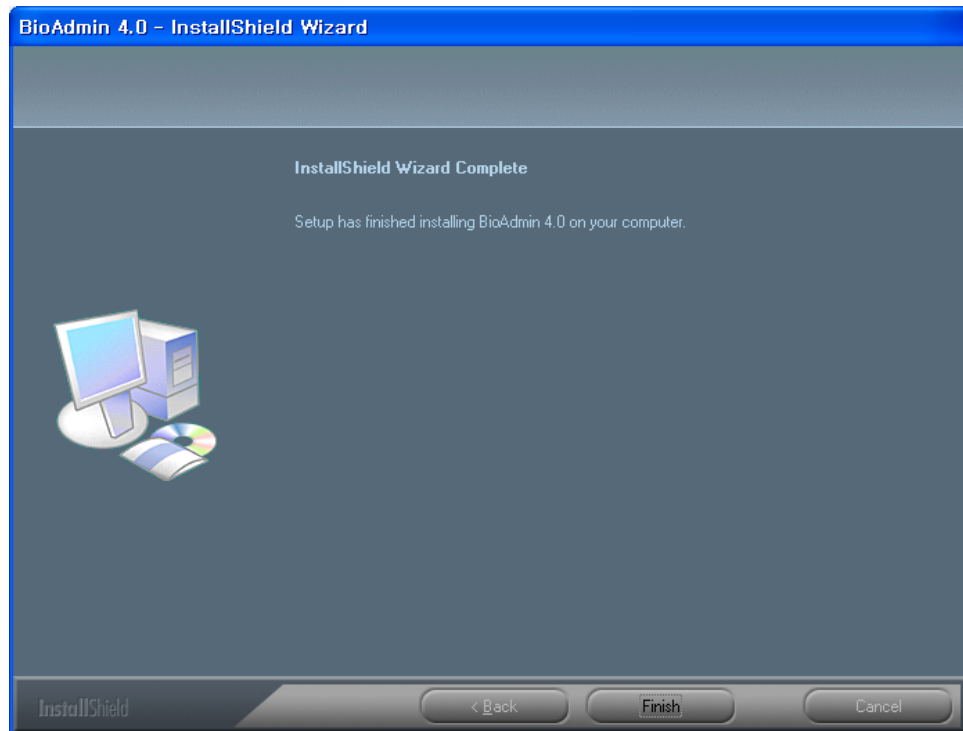

BioAdmin Client was successfully installed. Close the installation program and execute the BioAdmin Client.

#### 1.4.3. Using MySQL or SQL Server database

- - You can use MySQL or SQL Server database by the following procedures.
  - Using MySQL database
  - If you are already using MySQL Server, you can use the MySQL database instead of mdb.
- Execute **BioAdmin Server Config** menu.

- Click the **Configure** button on the Database field.
- On the **Data Link Properties** window, select **Microsoft OLE DB Provider for ODBC Drivers** and press **Next** button.

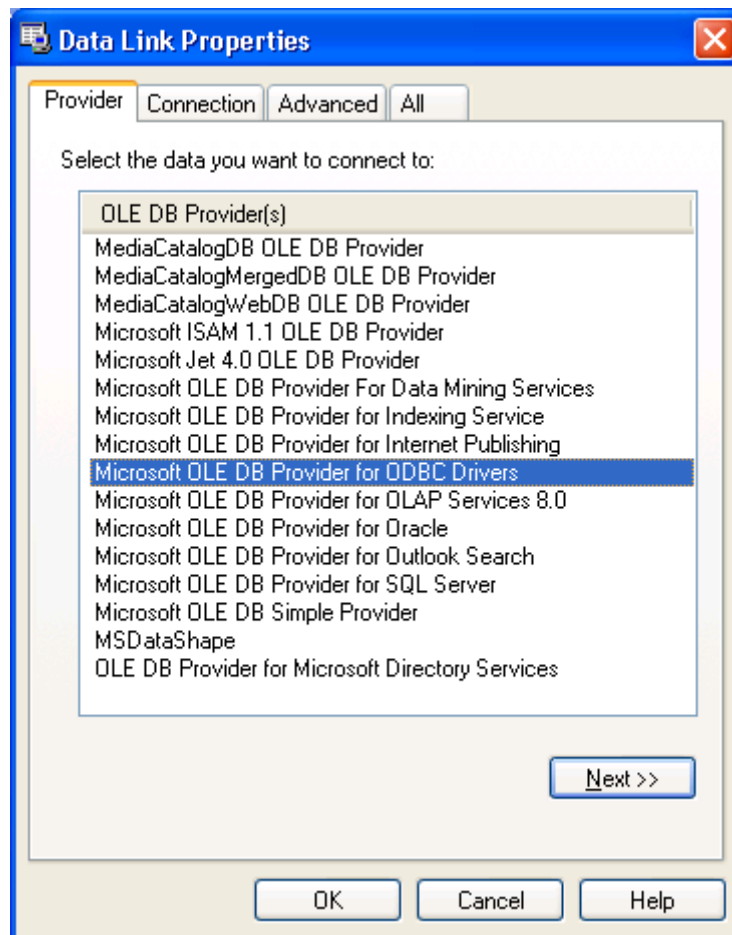

- Select data source name.

The screenshot shows the 'Data Link Properties' dialog box with the 'Connection' tab selected. The dialog is titled 'Data Link Properties' and has a close button in the top right corner. It contains four tabs: 'Provider', 'Connection', 'Advanced', and 'All'. The 'Connection' tab is active, and the text 'Specify the following to connect to ODBC data:' is displayed. Below this, there are three numbered steps:

1. Specify the source of data:
  - Use data source name  
A dropdown menu shows 'BioAdminData' and a 'Refresh' button is to its right.
  - Use connection string  
A text box labeled 'Connection string:' is below it, with a 'Build...' button to its right.
2. Enter information to log on to the server
  - 'User uname:' followed by a text box.
  - 'Password:' followed by a text box.
  - Blank password     Allow saving password
3. Enter the initial catalog to use:  
A dropdown menu is below this text.

At the bottom of the dialog, there are three buttons: 'Test Connection', 'OK', 'Cancel', and 'Help'.

- Enter the ID and password of the DB server. If there is no password designated, check on the **Blank password**. If there is any password, check on the **Allow saving password**.

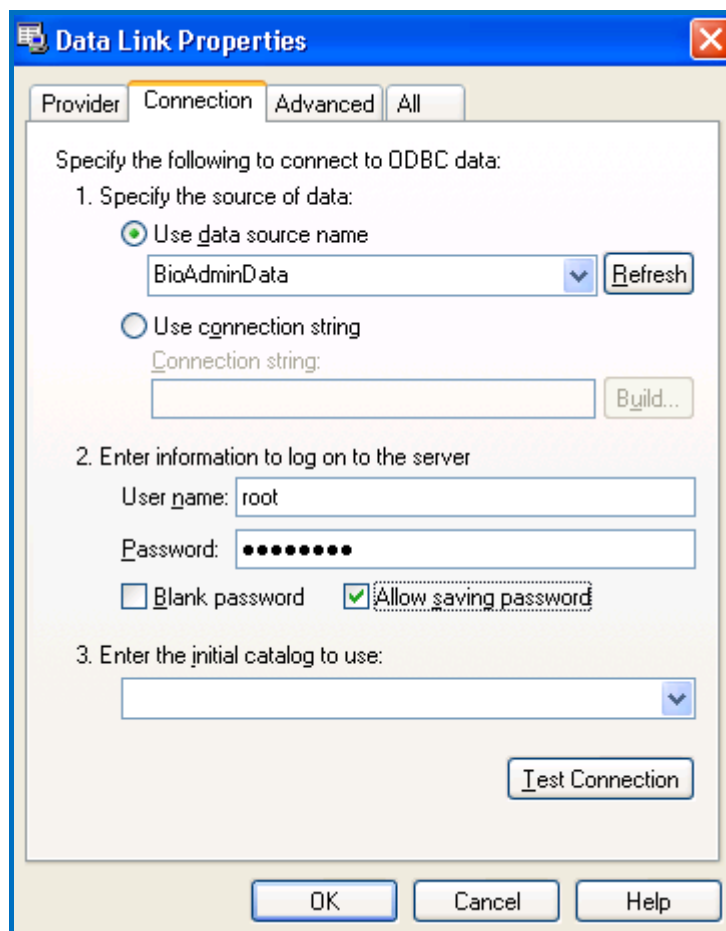

- Press **Test Connection** button to check the connection status.
- Press **OK** button.

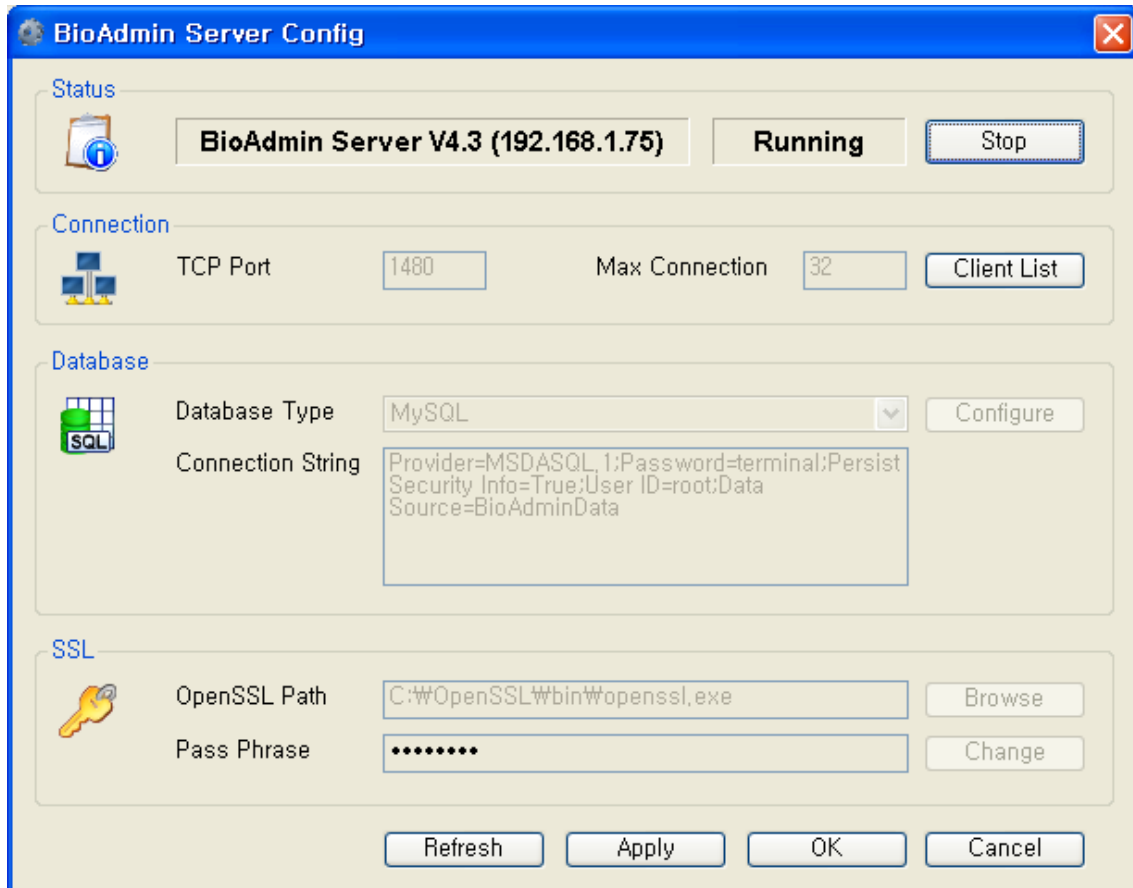

- Select the database type as **MySQL**.
- If you were already using the MySQL, press Apply button on **BioAdmin Server Config**. Press **Stop** and **Start** the BioAdmin server.

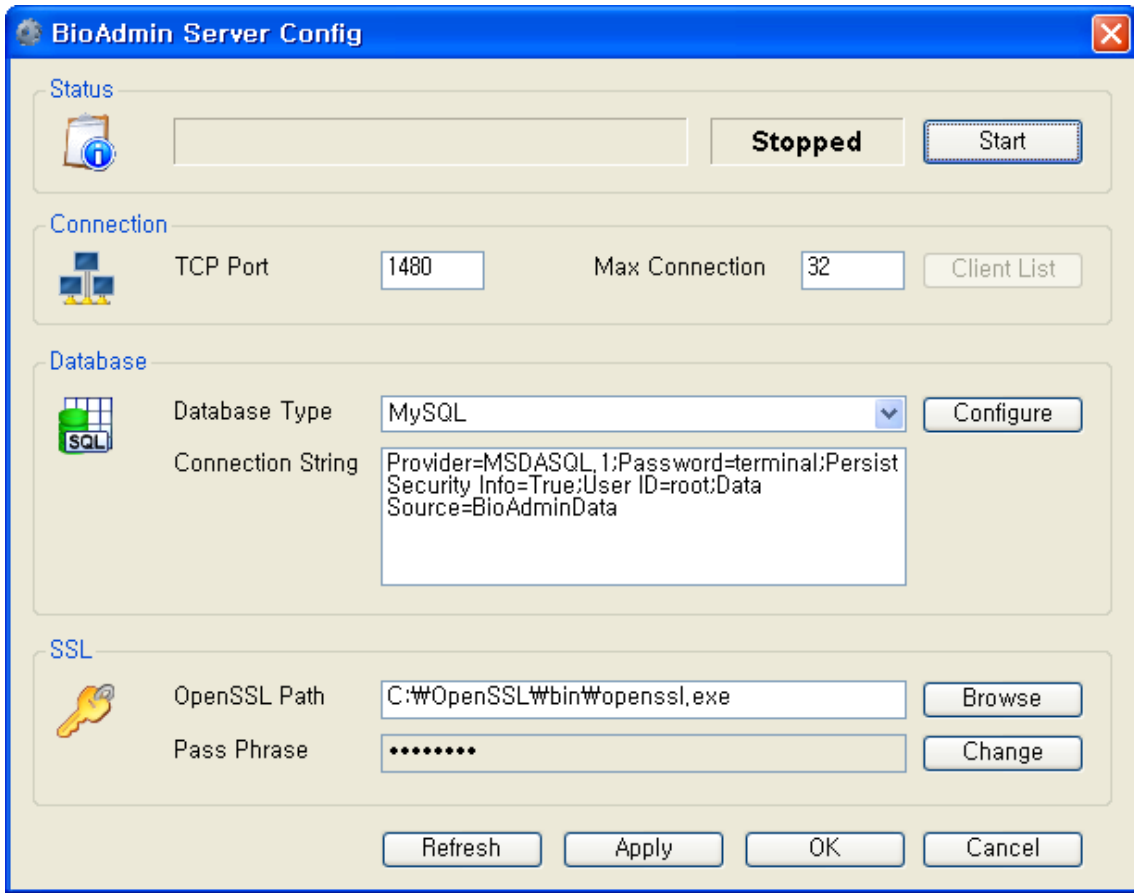

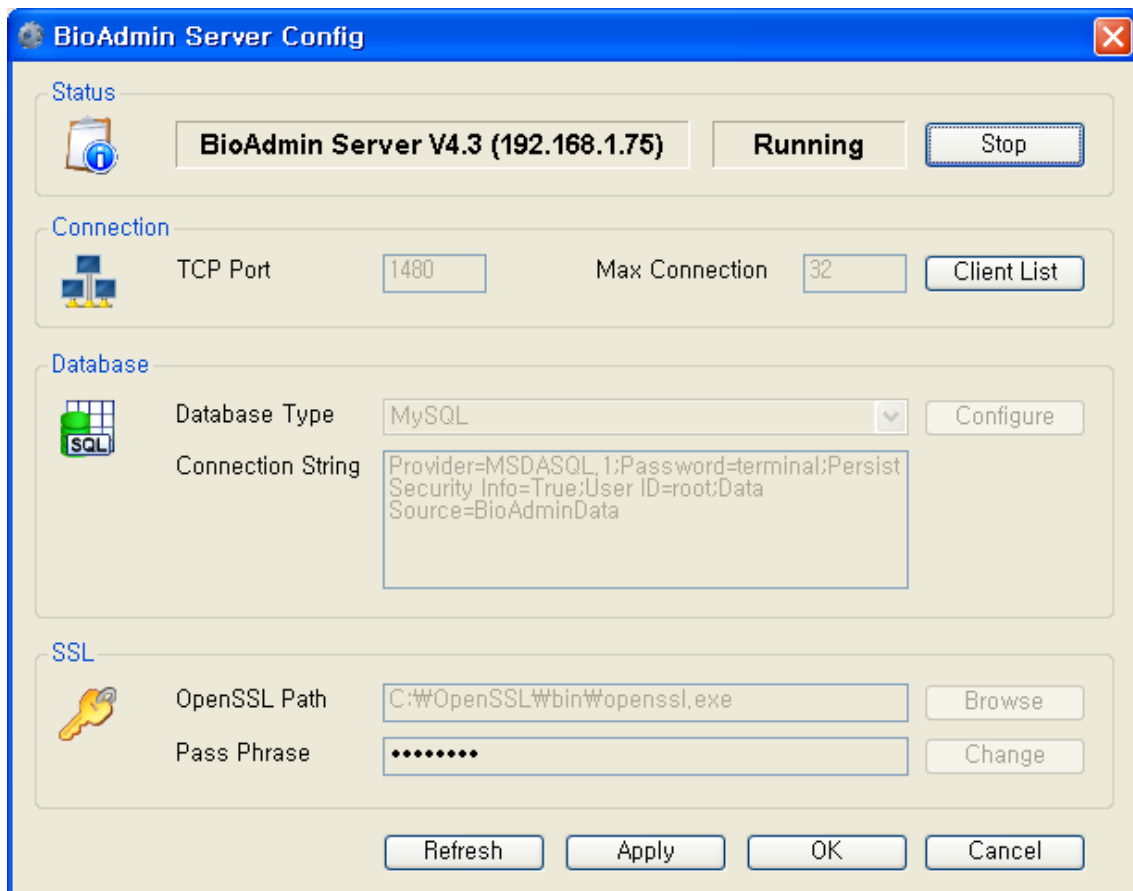

- If the status is changed as **Start**, press **OK** button.
- Using SQL Server database
 

If you are already using MySQL Server, you can use SQL Server database instead of mdb.

  - Execute BioAdmin Server Config menu.
  - Click the **Configure** button on the Database field.
  - On the **Data Link Properties** window, select **Microsoft OLE DB Provider for SQL Server** and press **Next** button.



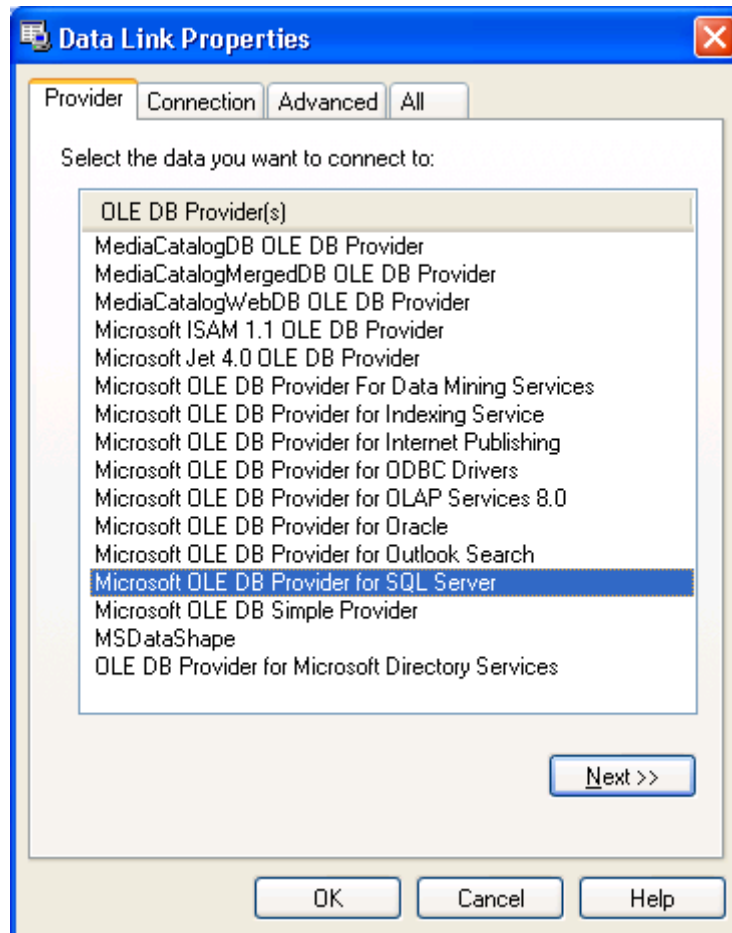

- Enter the SQL Server name.

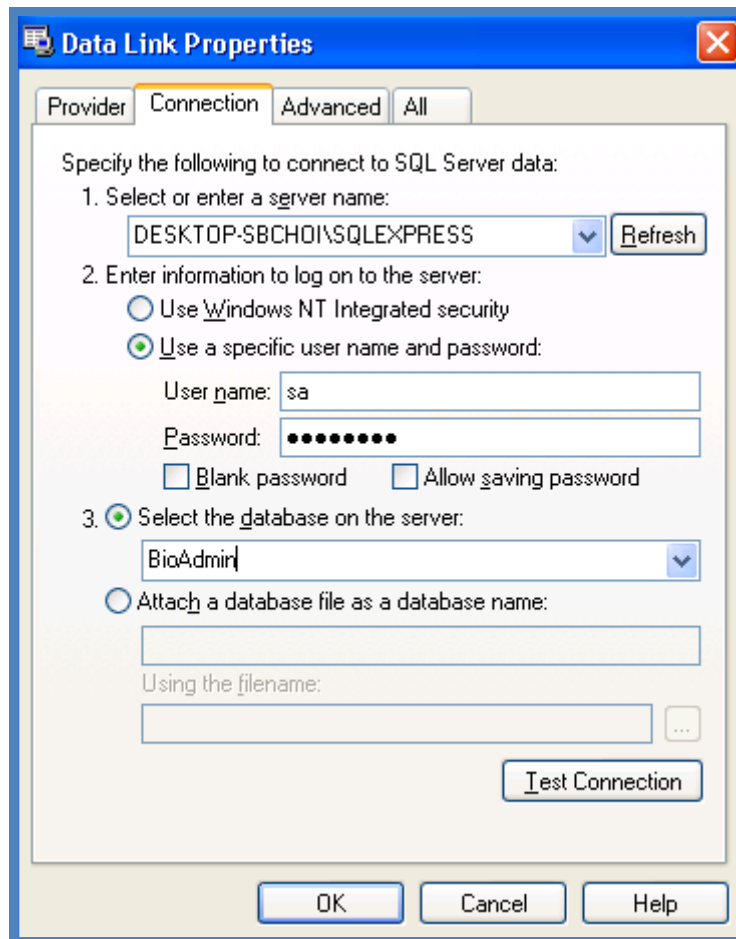

- Enter the User name and Password for the database server. If there is no password, check on the **Blank password**. If there is any password, check on the **Allow saving password**.
- Choose the **Select the database on the server**. To select this option, you should create the database in advance on the SQL Server.
- Press **Test Connection** button to check the connection status.
- Press **OK** button.

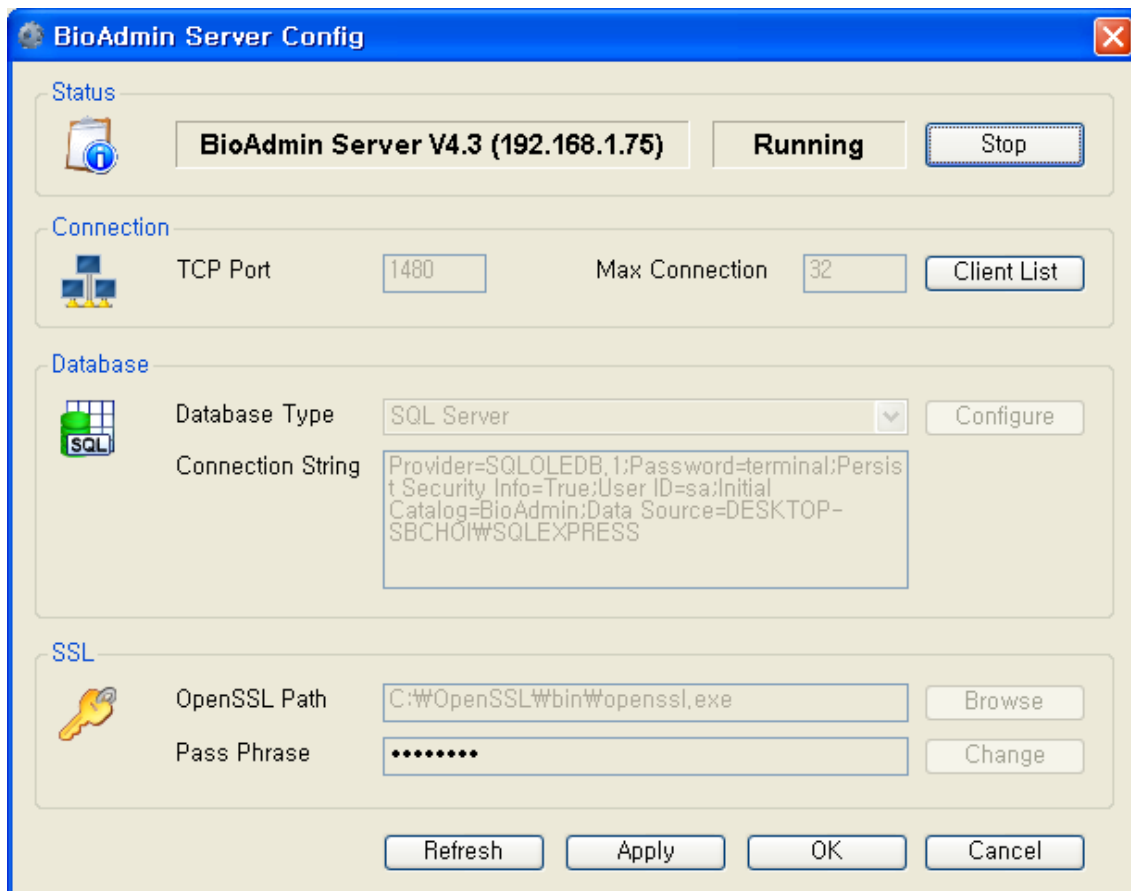

- Select the database type as **SQL Server**.
- Press **Apply** button.
- Stop and restart the BioAdmin Server.

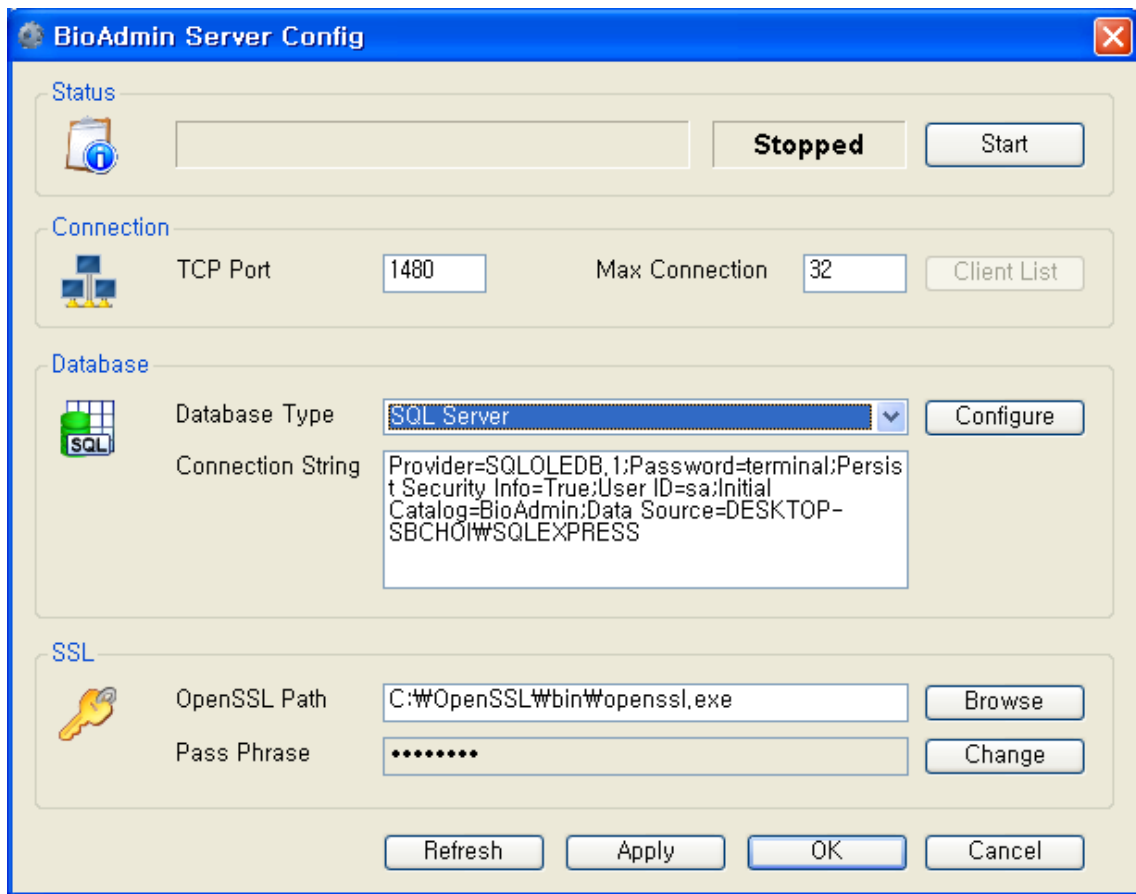

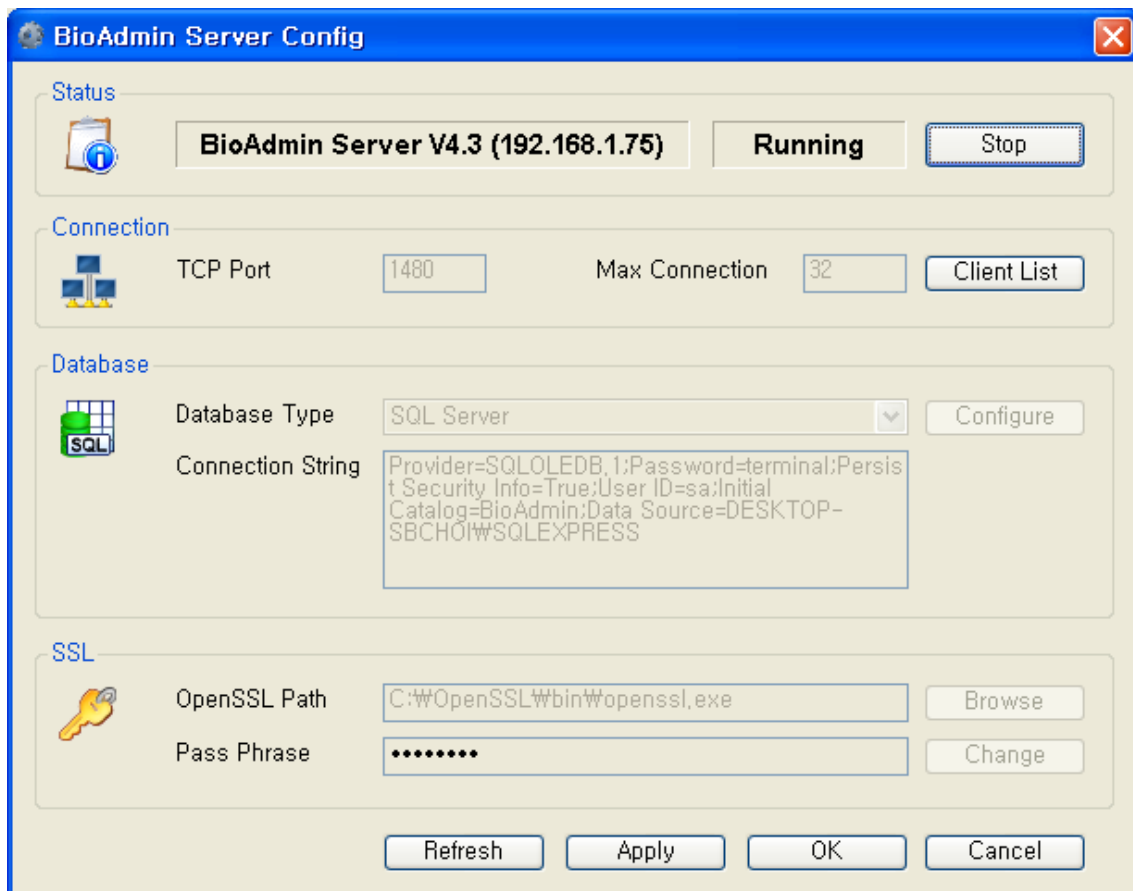

- If the status is changed as **Start**, press **OK** button.

#### 1.4.4. Check the BioAdmin software installation

- Network Configuration
- Configure the Network menu of the BioStation as to use the server. Ask the IP address of the server PC to your network manager. You can also check this IP address on Network connection page of your operation system. For more details on BioStation setting, refer to the BioStation Installation Guide.

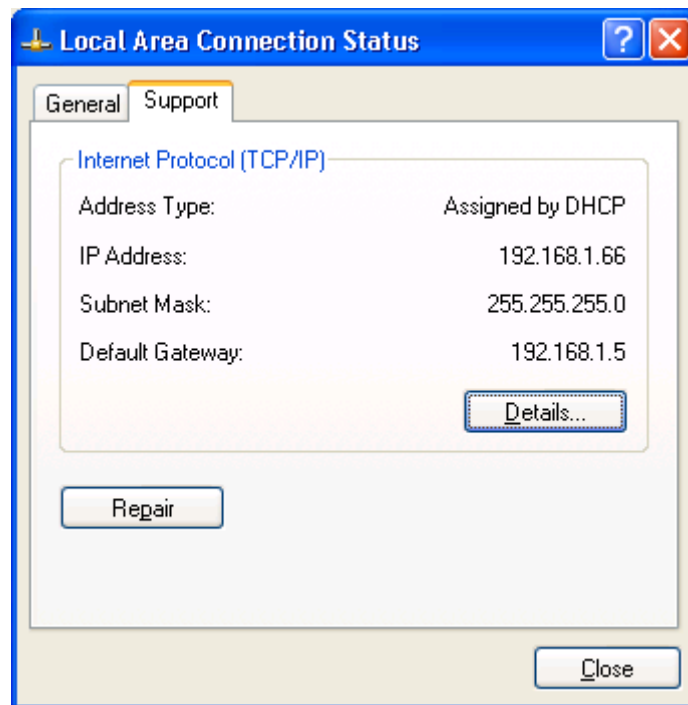

- If you change the BioStation setting to use the server, BioStation will try the connection with BioAdmin Server soon.
  - You can check the connected BioStation on BioAdmin Server Config window.
  - At this stage, BioStation was just connected to BioAdmin Server, but not managed by the BioAdmin Server. If you issue the certificate, BioStation will get managed by the BioAdmin Server.
  - If the BioStation is connected to the BioAdmin Server, BioAdmin Server will get the necessary information from BioStation. This may take a few minutes depending on the data size on BioStation. While receiving data from BioStation, you may not control the BioStation from BioAdmin Client.
- 
- Check Server Status
  - If you finished the installation of BioAdmin Server and BioAdmin Client, you can check the server status on BioAdmin Server Config window.

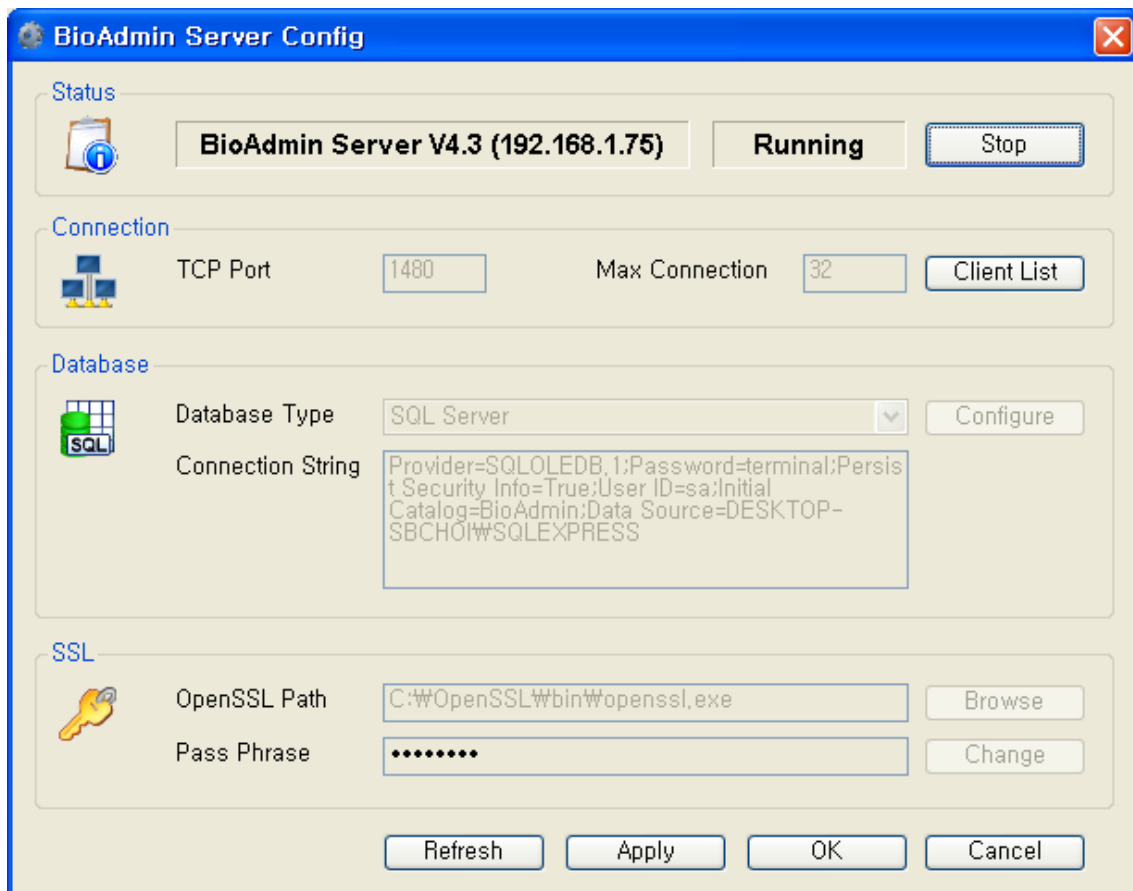

- Check the version and status of the BioAdmin Server.
- Enter the server IP and server port on BioAdmin Client.
- You can check the connection status by pressing **Test** button.

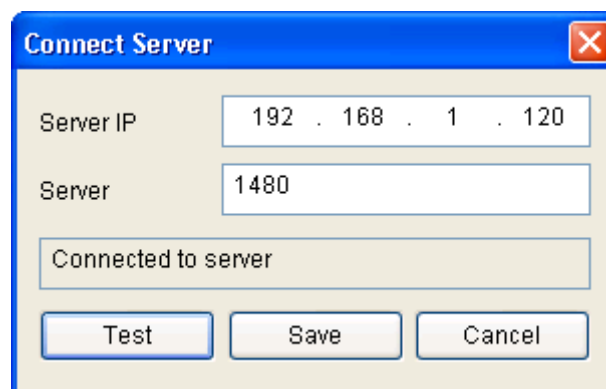

- If you can access to the BioAdmin Server, now you are ready to use the BioAdmin Server and BioAdmin Client.

**Note:** In case of installed BioAdmin Server successfully, it may occur not to

connect to server correctly. Please restart BioAdmin Server program.

You may go to Windows 'Start' -> 'Program' -> 'BioAdmin Server' to "Uninstall BioAdmin Server Service".

Run "Install BioAdmin Server Service" for restarting.

## 1.5. Log in to BioAdmin

### 1.5.1. Connect Server

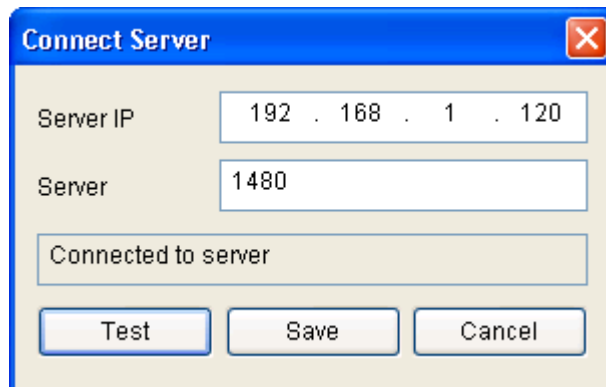

- Enter the server IP and server port.
- Press **Test** button and check whether the BioAdmin Client can access to the BioAdmin Server.
- Press **Save** button to store the server setting and access to that server.
- 

### 1.5.2. Registering the initial system administrator account



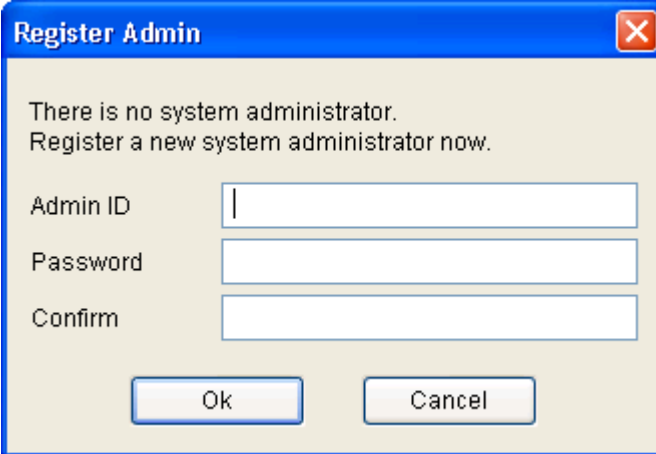

The 'Register Admin' dialog box has a blue title bar with the text 'Register Admin' and a close button (X) on the right. The main area is light beige and contains the following text: 'There is no system administrator. Register a new system administrator now.' Below this text are three input fields: 'Admin ID', 'Password', and 'Confirm'. At the bottom of the dialog are two buttons: 'Ok' and 'Cancel'.

- After entering Admin ID and password, press OK button. At this initial registering, you can put any Admin ID and password.
- This initial registration is required to open the BioAdmin Client program after installing the BioAdmin Server. Therefore, once you register this initial Admin ID and password, you can log in to the BioAdmin Client without registering additional admin account from the next time.
- 

### 1.5.3. Log in to the BioAdmin 4.3

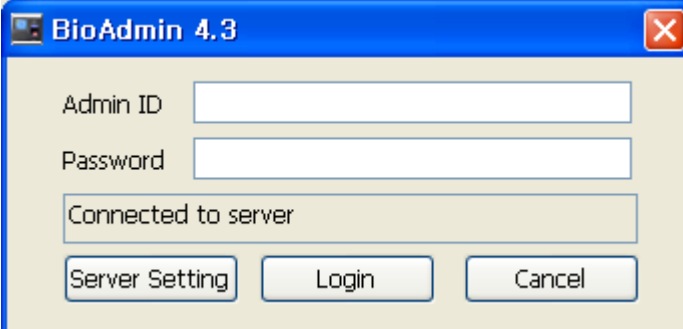

The 'BioAdmin 4.3' dialog box has a blue title bar with the text 'BioAdmin 4.3' and a close button (X) on the right. The main area is light beige and contains the following text: 'Admin ID', 'Password', and 'Connected to server'. Below this text are three buttons: 'Server Setting', 'Login', and 'Cancel'.

- After entering the Admin ID and password, press log in button.
- Enter the Admin ID and password you used upon registering the initial administrator account.
- You can see the server information by pressing the Server Setting button.

## 1.6. User Level on BioAdmin 4.3

You can differentiate the user level into three groups as below.

- Administrator : Administrator can change and see all the settings on BioAdmin software.
- Viewer : Viewer can see the settings, but cannot change any settings on BioAdmin software.
- User : User can see his log information.

## 1.7. BioAdmin configuration

BioAdmin Software is composed of 4 elements, command menu bar, main menu, task and utilities, and main window.

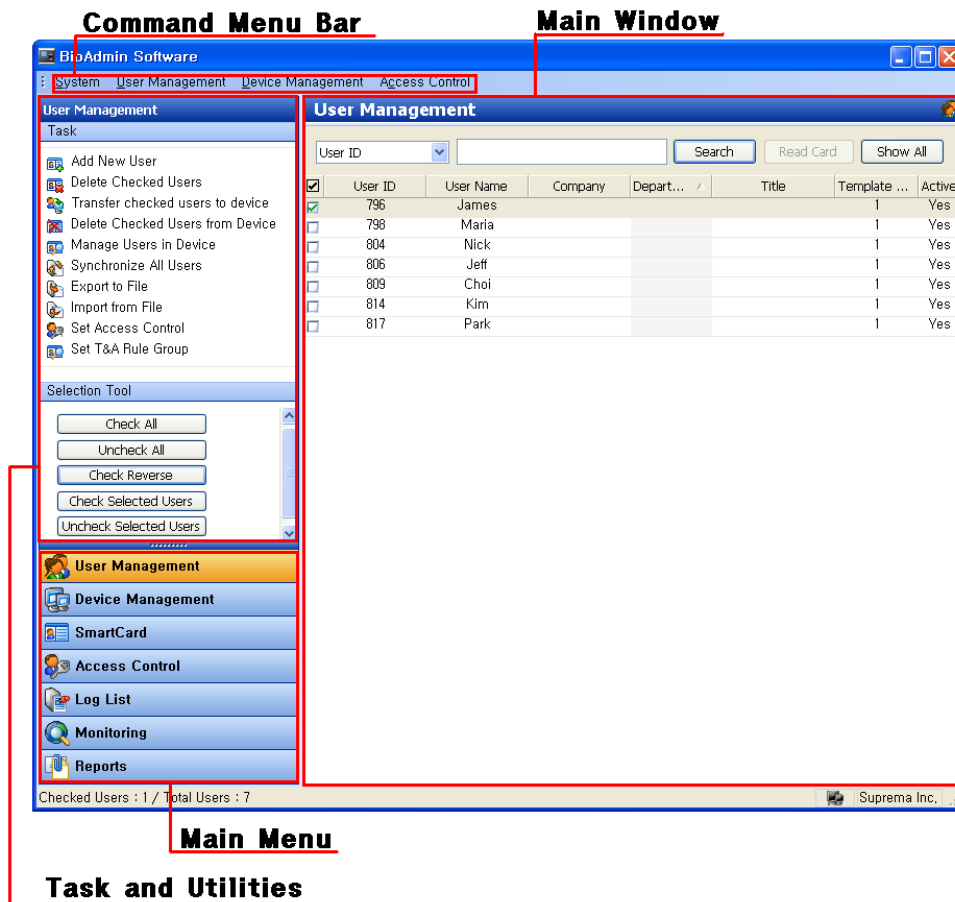

### 1.7.1. Command Menu bar

Command menu bar contains command items supported by BioAdmin software, which are grouped into 4 categories:

- System : admin. Account, back up database, restore backup, lock all devices, unlock all devices, upload 1. x version data, preference, BioAdmin information, and close
- User management : add new user, company management, department management, title management, and setup custom fields.
- Device management:: add new device, add new BEACon, set time, upgrade firmware, upload password initialization code/ password initialization, site key setting
- Access control : time code definition, holiday definition, time zone definition, door zone definition, and access group definition.

### 1.7.2. Main menu

Major command menus can be accessed by buttons on the left pane, such as user management, device management, smart card, access control, monitoring, log list, or report.

### 1.7.3. Task and Utilities

Task window shows sub-menus for the selected main menu

Utility window shows the User selection tool, Device tree, and Log filtering tool.

### 1.7.4. Main window

On each command menu, relevant information is updated on the main window.

Main window contains the following information and controls:

- Retrieved information from currently selected device
- Information stored on host PC, such as user database or log data
- Controls to manage or to configure the information

## 1.8. User Database

User database refers to the entire user information including user ID, user name and fingerprint information. BioAdmin software is based on user database management in priority.

That is, user database is created, updated and saved to host PC. Then, it is selectively distributed to BioEntry and BioStation devices connected to network via transfer.

Note : Difference between select and check – select is used when choosing each user ID in select tool box (press Shift button and choose a user with an arrow key ↓ or click the last user ID with a mouse, to select multiple users. ), whereas, check is to check each selected user ID. Using check tool, you can check all, uncheck all, reverse check, check user and uncheck a selected user with ease.

## 2. Options to determine before starting

### 2.1. Security Option

Security option is used to encrypting fingerprint template data which is used between host PC and BioStation. By encrypting the template data, you can enhance the security level of the system.

Security option should be used only when there is no fingerprint data on the BioStation. Otherwise, BioAdmin will remove all fingerprint templates on the BioStation.

Please refer to the “11.1.7 Preferences” Security Option for more in detail.

### 2.2. Template Format Option

It has been added ISO 19479-2 Standard template data support for BioEntry Pass™/BioEntry Smart™, BioStation™, BioEntry Plus™ devices.

To use this option, the device should not have user information on it, then it can be changed. In case of BioAdmin, it will be applied after deleting all template data.

Please refer to the “11.1.7 Preferences” Template Format Option for more in detail.

### 2.3. Access Control Option

From the BioAdmin V4.1, new type of Access Control information will be used for BioStation & BioEntry Plus. In case of previous version of Access Control, it should be decided which Access Control type use and which version use since it does not support BioEntry Plus. After using new version of Access Control setting, previous version won't be used. Lastly, in case of BioEntry Pass / BioEntry Smart, new Access Control setting won't be applied.

Please refer to the “11.1.7 Preferences” Access Control Option for Access Control setting and refer to the “7. Access Control” for Access Group setting.

### 2.4. Using Mifare Card

BioStation Mifare and Bioentry Plus Mifare models support 1K/4K Mifare Card, which is not compatible with Smart Card used in BioEntry Smart model, has

different setting.

Please refer to the “6. Smartcard/Mifare card” for more in detail.

## 3. Quick start

This chapter explains basic procedures of operating BioEntry, BioEntry Plus, and BioStation device integrated with external system.

### 3.1. Quick start with BioStation

This paragraph describes basic procedures of operating BioStation.

#### 3.1.1. Step 1 : HW installation

BioStation can be networked by cable/wireless LAN as well as by RS232,422,485. Also, BioStation can be use with host PC via USB interface. For details on installation, refer to BioStation installation manual.

#### 3.1.2. Step 2 : Search new device

- Run BioAdmin software.
- Enter login ID and password.
- Select device management on main menu to display device management page on main window.

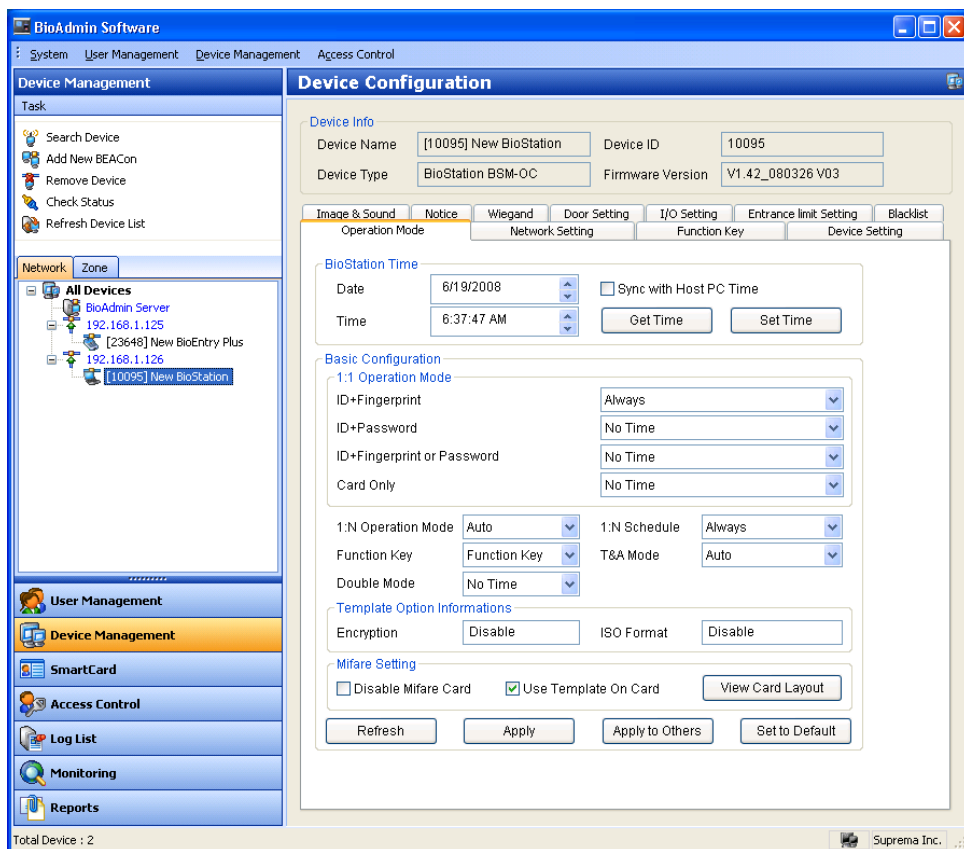

- Once the BioStation is connected to the BioAdmin Server, connected BioStation will be added to the device tree whenever you start the BioAdmin software. Also, you can see the connected BioStation by pressing the **Refresh Device List**. Even though a BioStation is properly connected to the BioAdmin Server, it may take several minutes to show up on the device tree.
- 
- If a BioStation is unauthorized one, an orange color is indicated on the BioStation icon. In this case, you cannot communicate with that unauthorized BioStation.



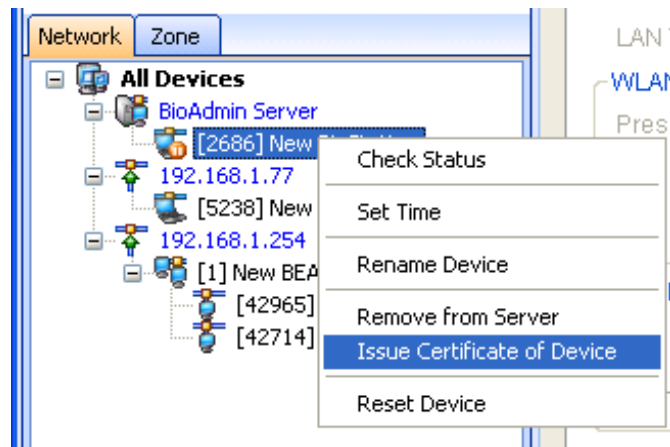

To communicate with the BioStation, select the unauthorized BioStation and press the right button of the mouse. Press **Issue Certificate of Device** menu. After issuing the certificate, you can use this BioStation.

Because the BioStation restart after issuing this certificate, it may take a few minutes to show this BioStation again on the device tree.

- 
- After the certificate is issued for the BioStation, orange mark will be removed from the BioStation icon. This means that you can communicate with the BioStation without any problem.

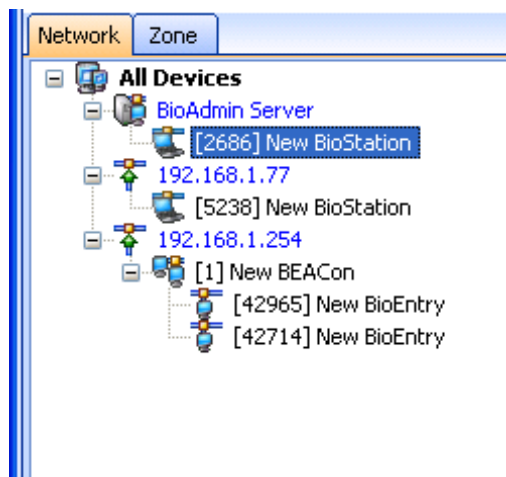

- Select Search device menu, click BioStation search, select a desired network out of serial port TCP/IP and USB device (BioStation) and press search button.

Note : If you find a device from search results

Ex.) searching 192.168.1.101 (port : 1470),

Detected device : new BioStation – device number

Finish device search.

Search result '— device(s) found' is displayed. Press OK button to select a device.

**Add New Device**

BioEntry     BioStation     BioEntry Plus     BioLite Net

Serial Port

COM Port: COM1    Baudrate: [ ]

TCP/IP

IP Addr: 192 . 168 . 1 . 136    Port: 1470

USB Device (BioStation)

USB Virtual BioStation: A: [ ]

UDP (BioEntry Plus / BioLite Net)

Search

Ok    Cancel

- Once it's connected to device successfully, new device ID and network connected to device are also displayed in device tree window.

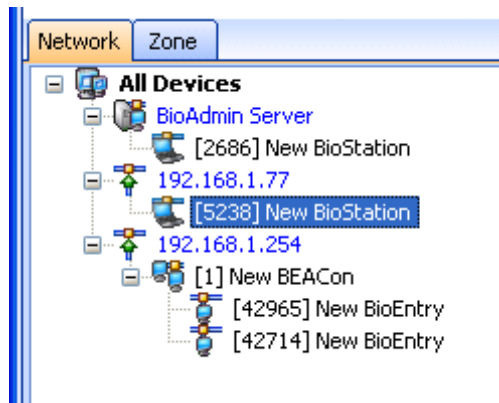

- Select user management button on main menu and select Manage users in device on task window.
- Once device is selected, fingerprint information such as user ID, number of fingerprint, access group, security level and select is displayed.

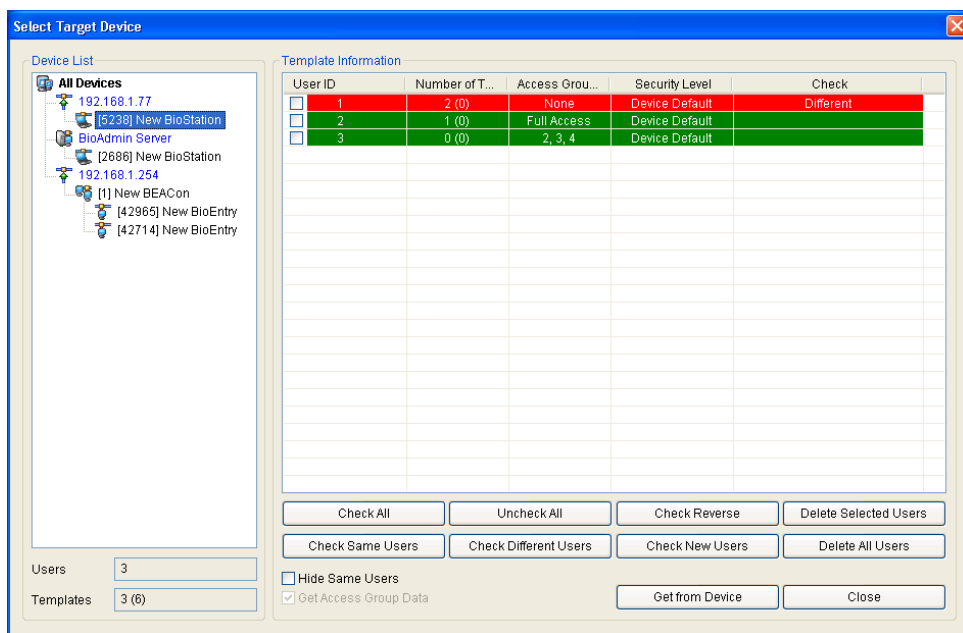

### 3.1.3. Step 3: Connect device

- Select Device Management menu to display device management page on main window.

BioAdmin software network setup is divided into network, serial port and USB connection. Change settings and apply them to device.

Network setup is to designate settings for local and wireless network connection.

You need to designate the port as “1470.”

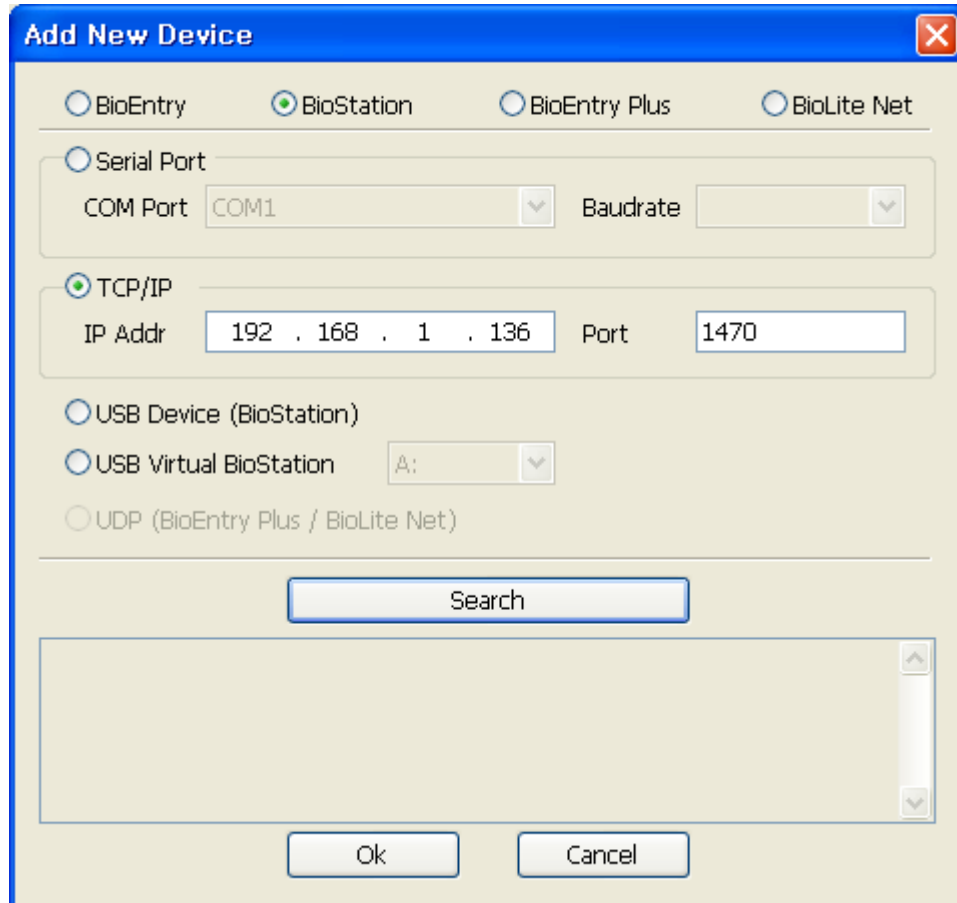

Administrator needs to know IP address and port # (1470). Once device is connected properly, IP address is displayed as one group and device ID is displayed with a bracket [\*\*\*\*] on device tree window.

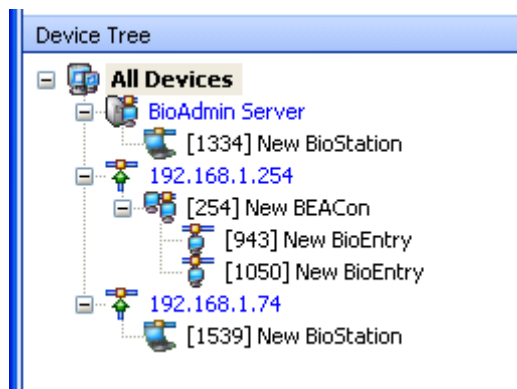

- Wireless network setup

Set up free set name, network name (SSID), data encryption, key type, and network key check on wireless network setup before operation.

Applying DHCP, you can set automatic upload of IP address on BioAdmin in order to get IP address automatically, check such an IP address and search a device in device management.

When setting IP address manually, you can search a device by specifying assigned IP address, gateway and subnet mask.

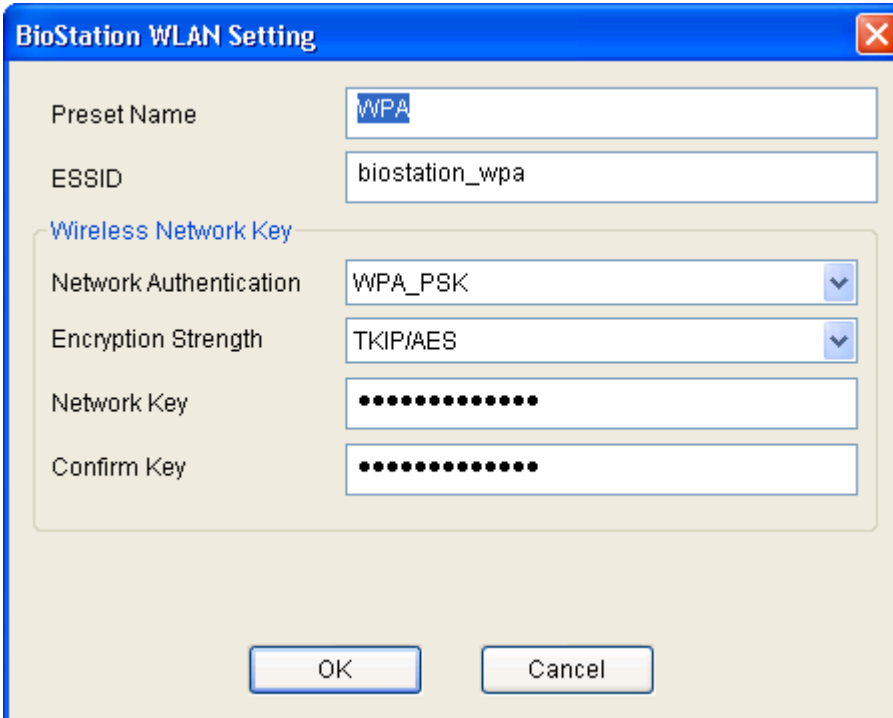

The screenshot shows a dialog box titled "BioStation WLAN Setting". It contains the following fields and options:

- Preset Name: WPA
- ESSID: biostation\_wpa
- Wireless Network Key section:
  - Network Authentication: WPA\_PSK
  - Encryption Strength: TKIP/AES
  - Network Key: [Masked]
  - Confirm Key: [Masked]

Buttons: OK, Cancel

- Serial

On RS422/485 network, a new device can be detected automatically or added by new device search menu in device management. Once device is connected to network properly, device ID will be displayed with a bracket [\*\*\*\*] under port on device tree window.

Baudrate in RS485 / RS232 interface represents the frequency of carrier wave changing status per sec. In communicating with BioStation device, default is 115200 but if any trouble, lowering the baudrate can solve the problem.

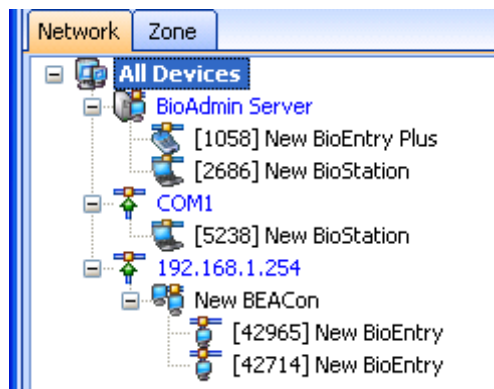
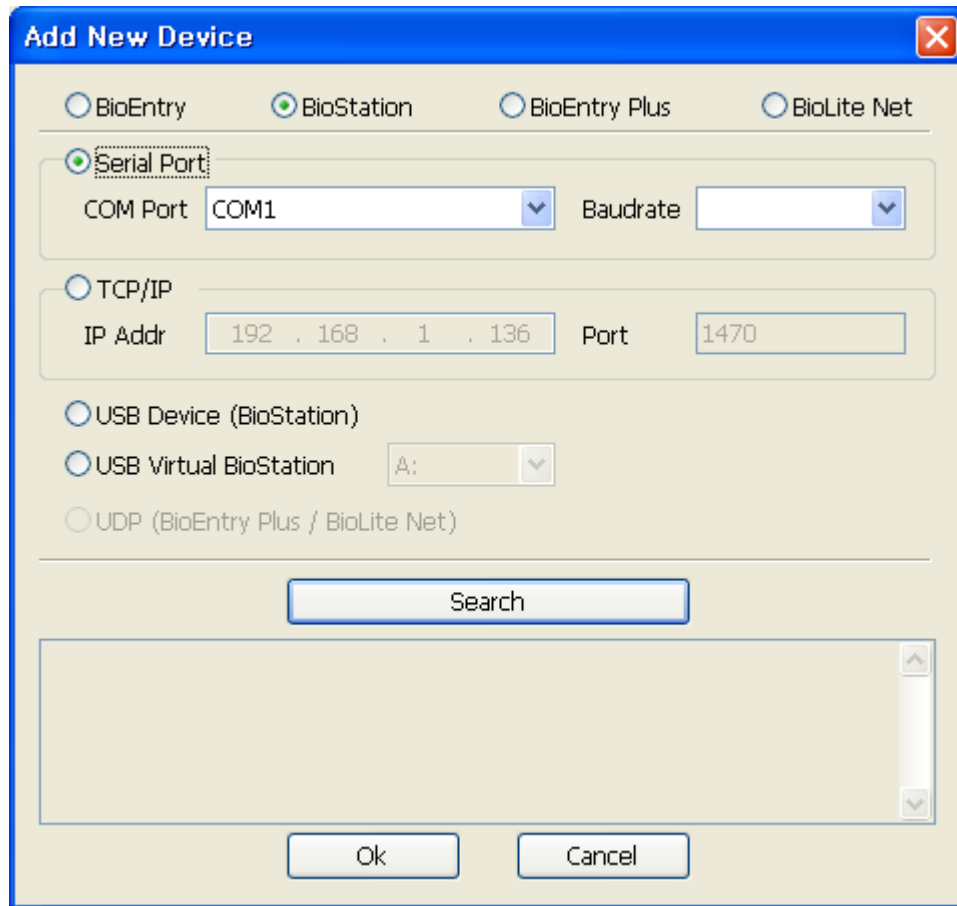

Although a device is disconnected from network, it still remains on device tree window. Remove device menu is used when removing a device from device tree window.

Device name can be changed using change device name menu but device ID can't be changed as it is fixed as one.

### 3.1.4. Step 4: User management

- Select user management menu to display user management page on main window.

Note : In user management, user related information can be divided into basic information and fingerprint information. Basic information includes user ID, name, company, dept., position and telephone number. Fingerprint information is about user's fingerprint.

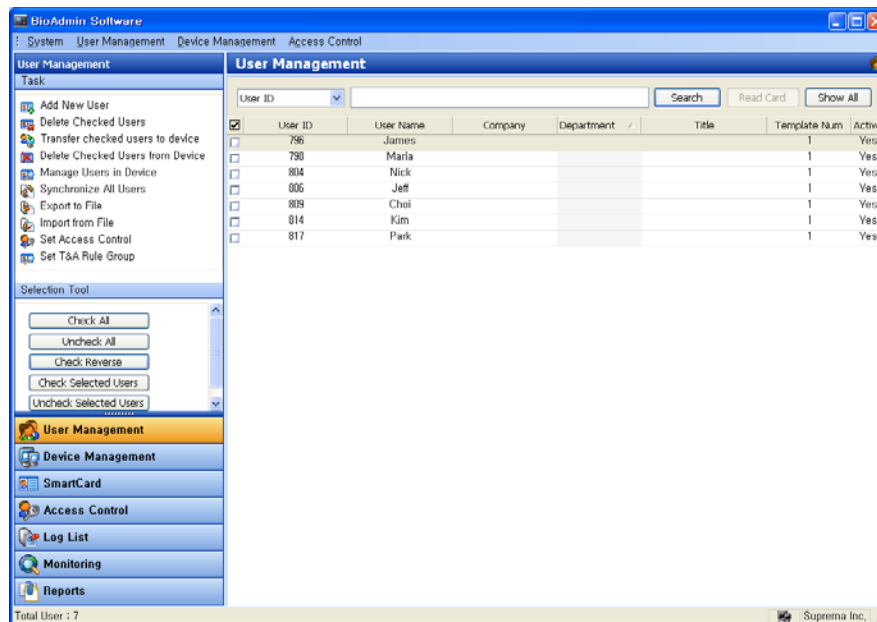

- Select add new user menu on task window to pop up a window.

**User Data Information**

User Information | Custom Fields | Fingerprint | User Time Attendance Rule

**Basic Personal Information**

User ID: 1

Name:

Company: None

Department: None

Title: None

**Details**

Phone:

Mobile:

E-Mail:

Gender: Male

Date of Birth: 10/16/2007

Start Date: 1/1/1970

Expiry Date: 12/31/2030  0 h

**Access Group**

Status:  Active

Group 1: Full Access

Group 2: None

Group 3: None

Group 4: None

**Entrance Limitation (BioStation)**

Daily Limit: 0 (0:00~23:59)

Timed APB: 0 Minute

**Other Information**

Password:  BST Admin Level: Normal User

- Click user information tab and enter user information.



- User can type Phone, Mobile, E-mail, Gender, and Date of Birth, then User Data Information will be indicated as Issue Date, which can be configured Expiry Date of user.
- In case of applying access control, please check mark “Active” of Access Group Status and select group what you already generated.
- Daily Limit is to make verification available of daily limitation. In case of setting timed APB, it will be possible to verify it again after at least one time verification.
- In addition, private password can be created, which is used for password verification.
- Please click “Custom Fields” to create more detailed user data information.
- Choose company, dept. and title using a combo box.
- To add a new company, dept., or title information, press  button or enter

company, dept. or title in information input window and then press add button.

- To save added information, press Close button.

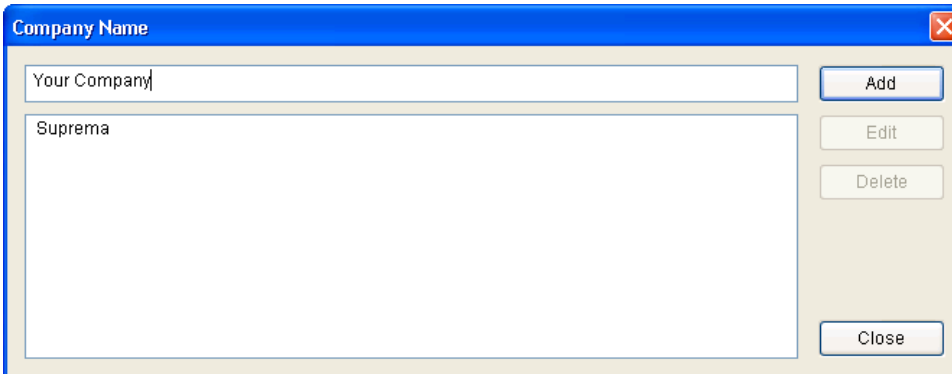

The screenshot shows a window titled "Company Name" with a blue title bar. Inside the window, there is a text input field at the top containing "Your Company|". Below it is a list box containing the text "Suprema". To the right of the input field and list box are four buttons: "Add", "Edit", "Delete", and "Close". The "Add" button is highlighted with a blue border.

- To enroll user's fingerprint information, click fingerprint tab.
- Fingerprint input process is divided into one by USB fingerprint scanner and the other by BioStation device.
- How to input fingerprint information using USB fingerprint scanner is as follows.

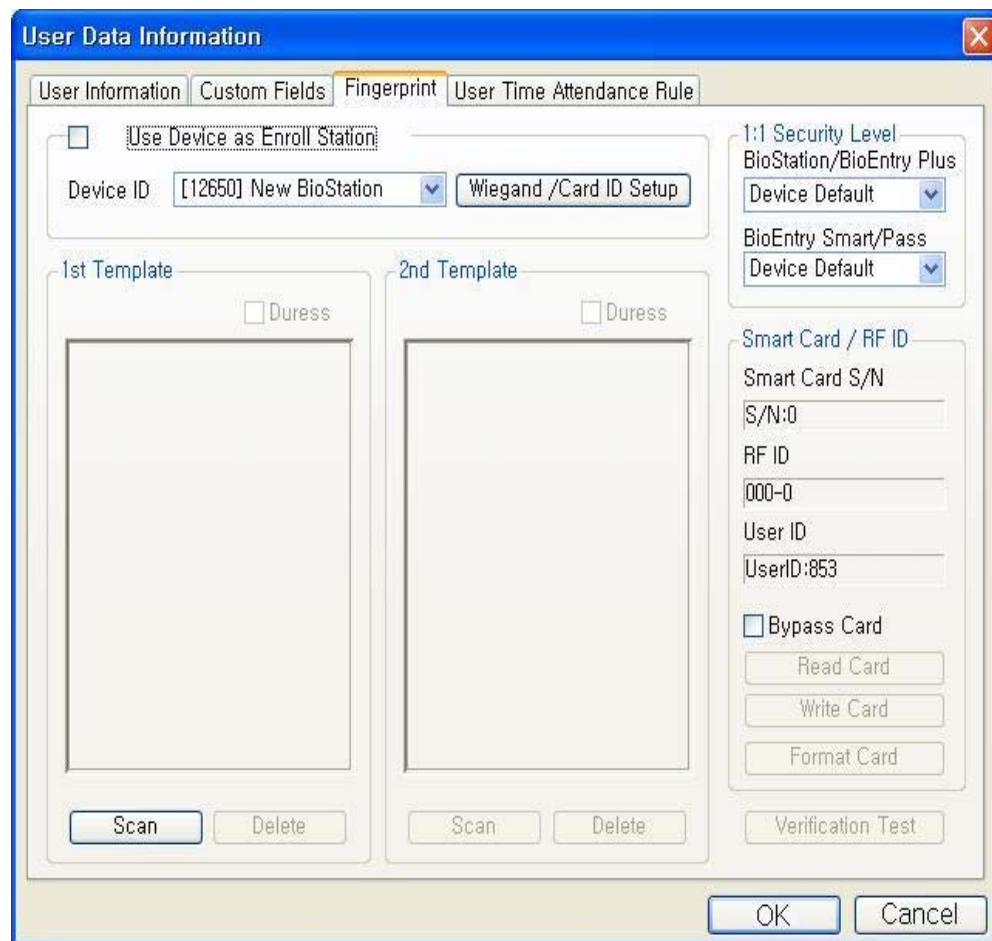

- Press scan button, place a finger on USB fingerprint scanner twice and input the first fingerprint information.

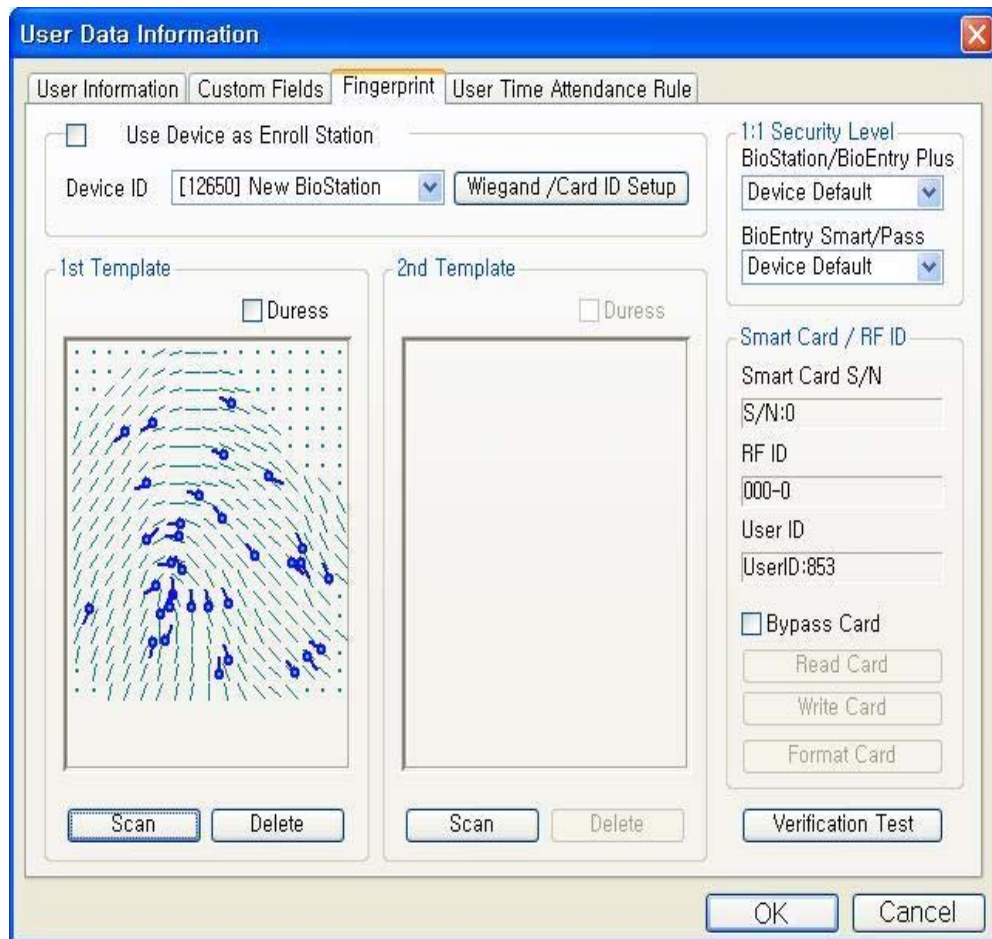

- Input the second fingerprint information in the same way as the first fingerprint information input process.

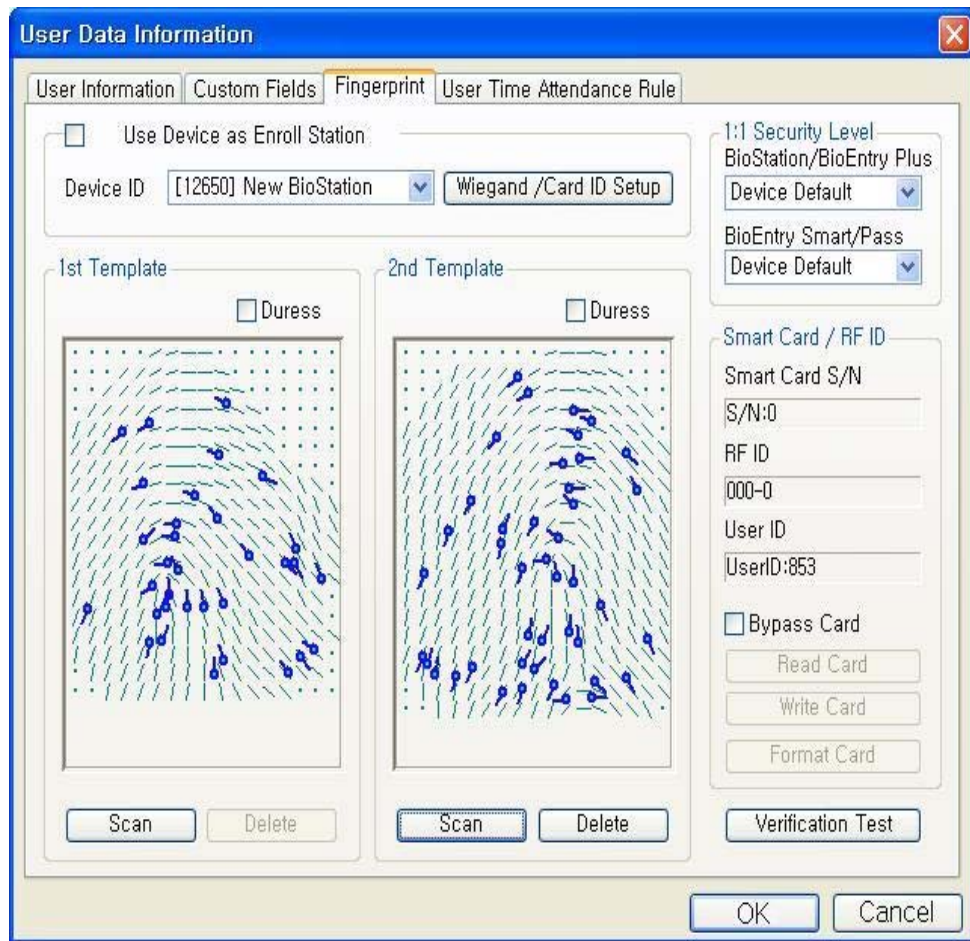

- How to enter fingerprint information by BioStation device is as follows.

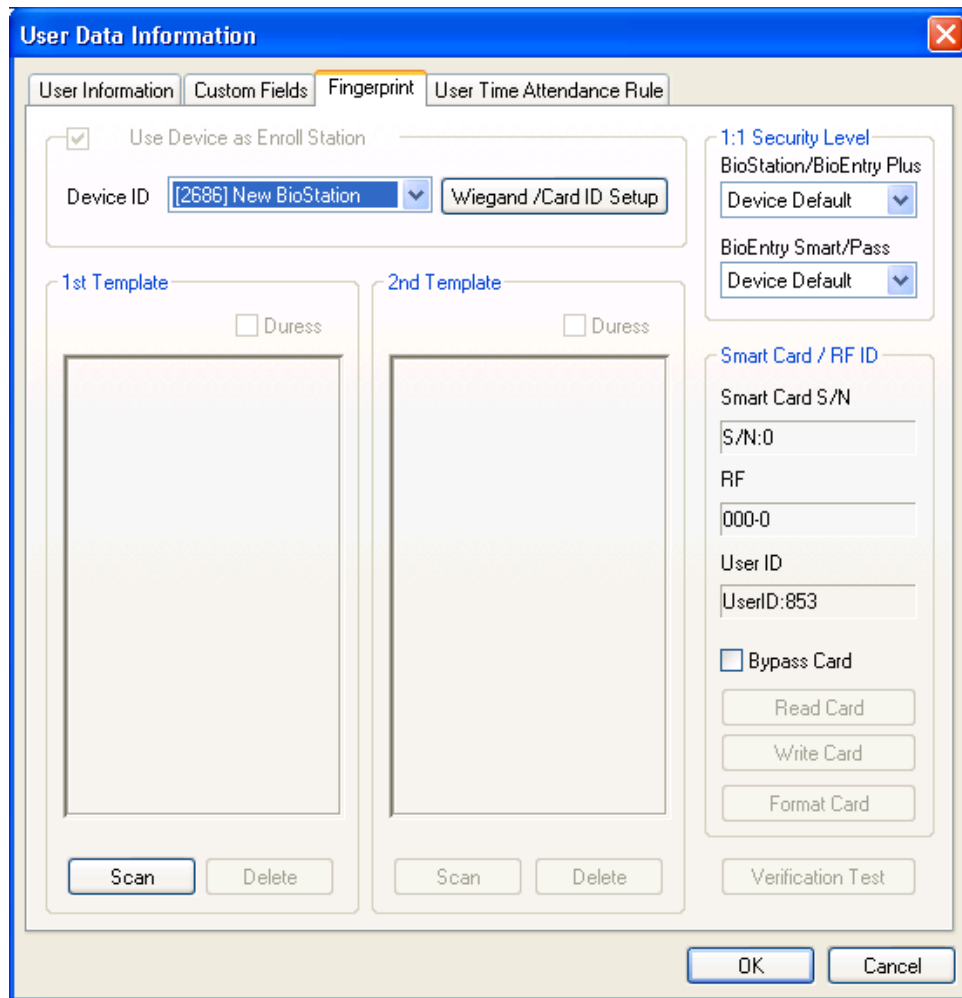

- In case of stand alone mode without USB scanner, check Use BioStation as Enroll Station, press scan button, place a finger twice on device and then input the first fingerprint information. In case that device is configured by 2 or more networks, specify BioStation ID, press scan button, place a finger on device twice and then input the first fingerprint information.

The screenshot shows the 'User Data Information' dialog box with the 'Fingerprint' tab selected. The 'Use Device as Enroll Station' checkbox is checked. The 'Device ID' is set to '[2686] New BioStation' and the 'Wiegand /Card ID Setup' button is visible. The '1:1 Security Level' is set to 'BioStation/BioEntry Plus' with a 'Device Default' dropdown. The 'BioEntry Smart/Pass' is also set to 'Device Default'. The 'Smart Card / RF ID' section includes fields for 'Smart Card S/N', 'S/N:0', 'RF', '000-0', and 'User ID', 'UserID:853'. There are buttons for 'Read Card', 'Write Card', and 'Format Card'. A 'Verification Test' button is also present. The '1st Template' and '2nd Template' sections each have a 'Duess' checkbox and 'Scan'/'Delete' buttons. The '1st Template' area shows a fingerprint scan with blue dots and lines.

- Input the second fingerprint information in the same way as the process of first fingerprint information input.

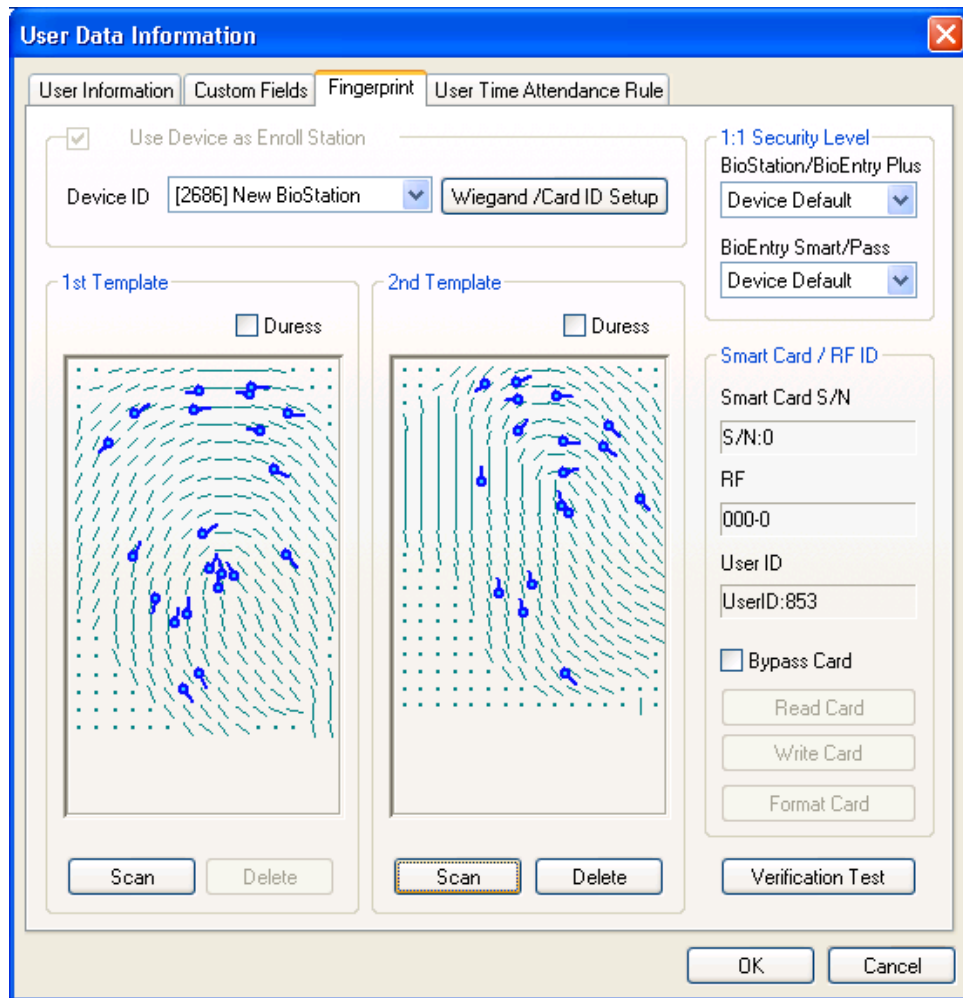

- To close enroll process, click OK button. Then you can see enrolled user information on user list window. This means user information has been added to Database in host PC.

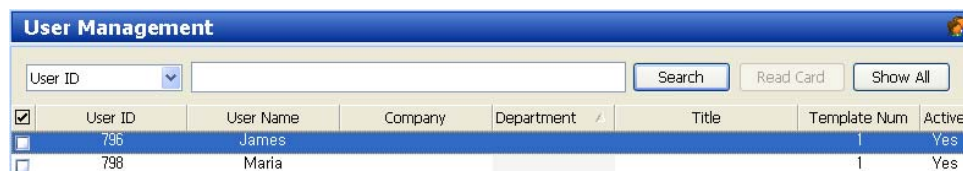



### 3.1.5. Step 5: Issue Mifare card

- In case of selecting BioStation Mifare / BioEntry Plus Mifare (2.4 Using Mifare Card), user Mifare card can be issued using BioStation Mifare.
- Double click the user on the “User Management”, then it will be appeared ‘User Data Information’.
- Click Fingerprint tab on the ‘User Data Information’.
- Select Mifare card as PC USB smart card device and click ‘Write Card’ button.

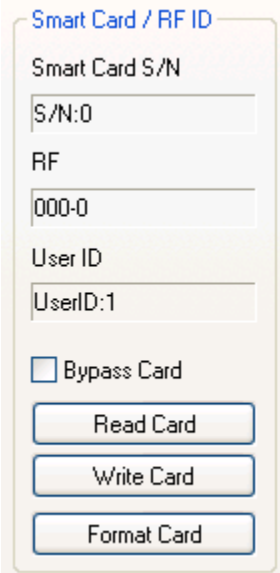

Smart Card / RF ID

Smart Card S/N

S/N:0

RF

000-0

User ID

UserID:1

Bypass Card

Read Card

Write Card

Format Card

- ‘Site Key’ window will be appeared for the first time use. Please type correct site key and press OK button to complete issue process (in case of ‘Blank’ type, the default value will be used)

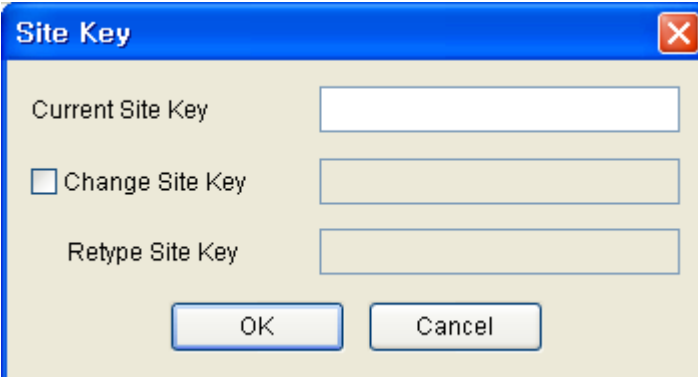

Site Key

Current Site Key

Change Site Key

Retype Site Key

OK Cancel

- Smart Card information for the stored user data on the “User Management”.

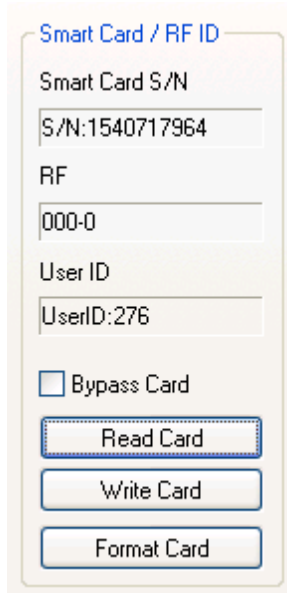

Smart Card / RF ID

Smart Card S/N  
S/N:1540717964

RF  
000-0

User ID  
UserID:276

Bypass Card

Read Card

Write Card

Format Card

This Smart Card S/N is read only when issued for using PC USB smart card device, BioStation Mifare or BioEntry Plus Mifare can be used through 'Read Card'.

- Select “Smart Card” menu, then you will see the added smart card list.

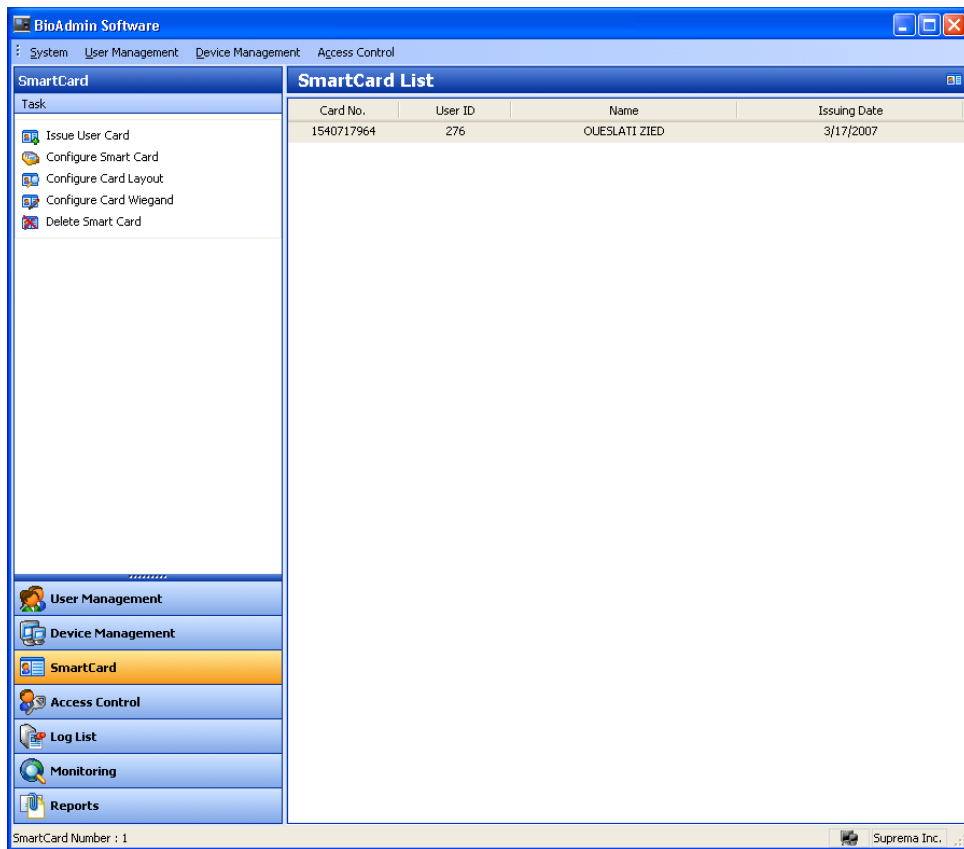

### 3.1.6. Step 6 : Rules on user T&A event control

New T&A rule can be applied by day.

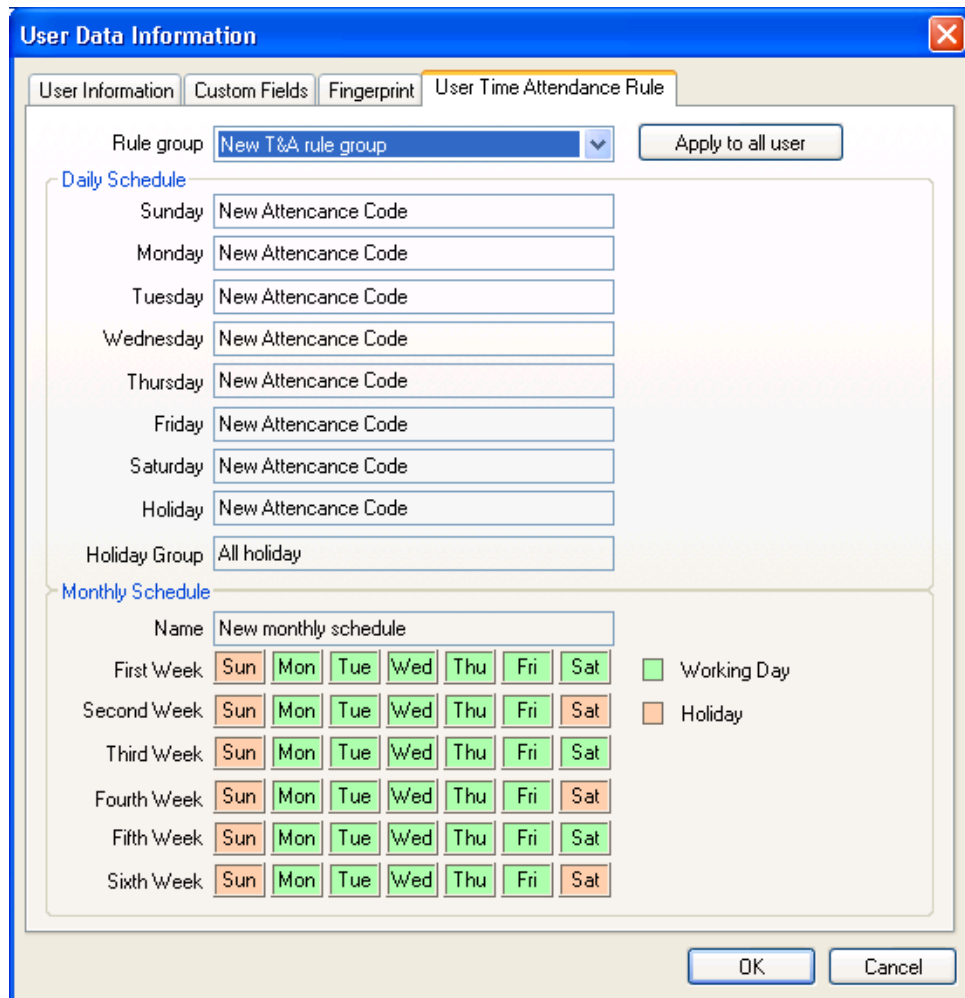

3.1.7. Step 7 : Enroll user with 'transfer checked user to device' menu

**Transfer checked user to device** is used to transfer user database from host PC to BioStation. User information such as user ID, fingerprint information, access group and security level is transferred through this process.

- Check enrolled user



- Click 'transfer checked user to device', check 'device' and click ok (select) button.

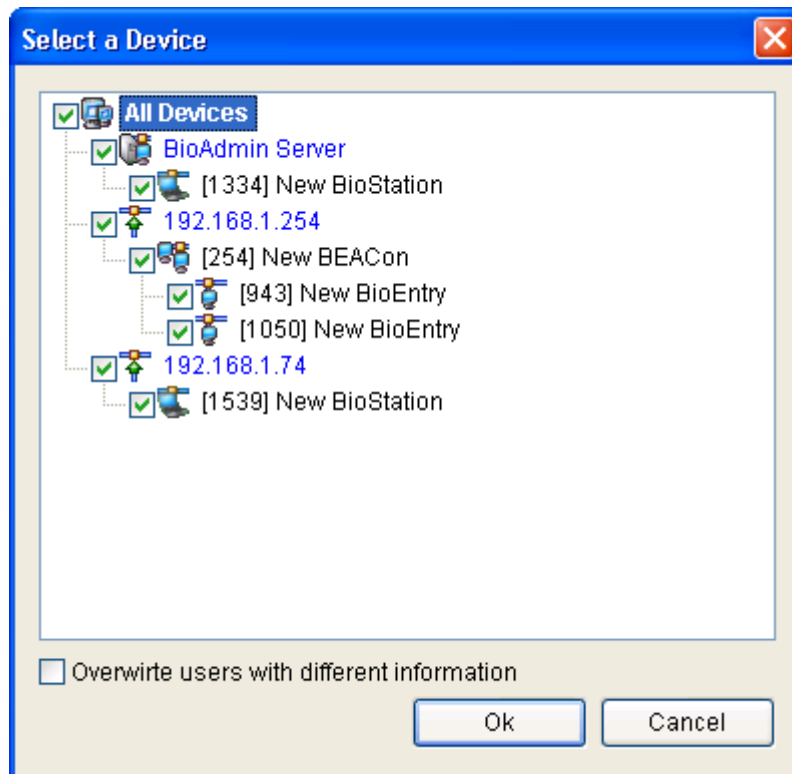

Press **Manage users in device** button and click device. If user information fields are indicated in yellow, it means user information has been transferred to device successfully.

### 3.1.8. Step 8: Monitoring

- Select **Monitoring** menu to show Monitoring display on main window.
- Select **Monitoring setting** menu and double click Monitoring on/off. To save, click ok button. To start monitoring for linked all BioStation devices, select **start monitoring**.

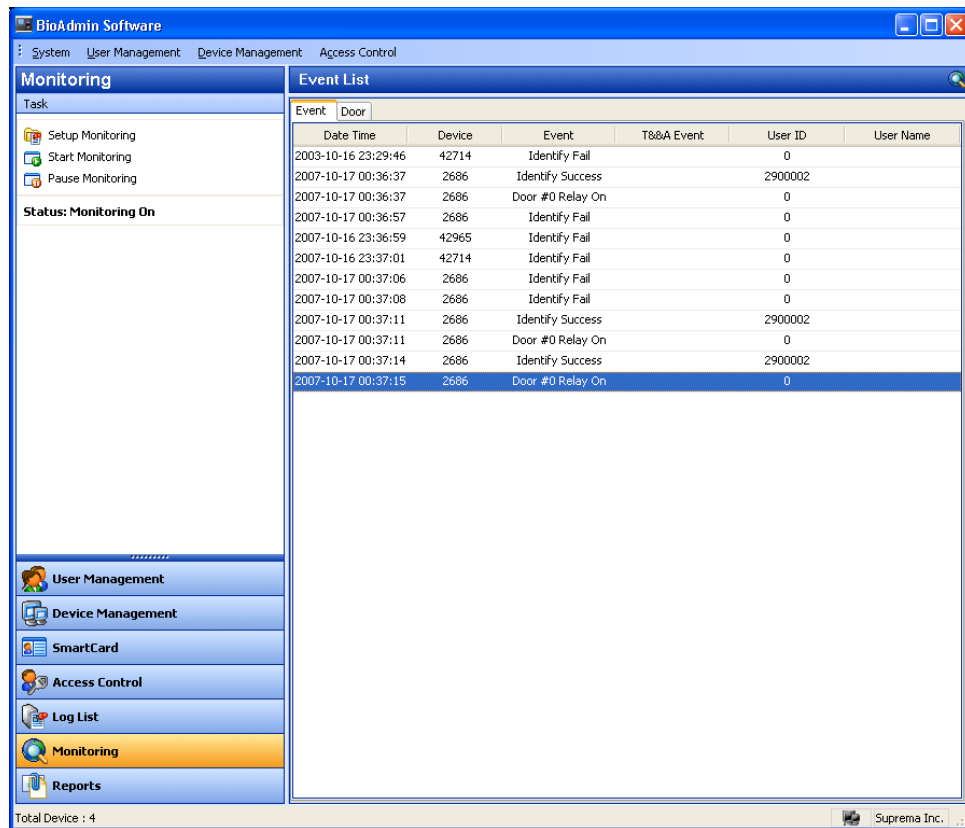

### 3.1.9. Step 9: Log List

- Select the **Log List** menu. Then, the log list window appears on the main window.
- Select the **Get Recent Logs / Auto Upload** button to see the updated event log data added to the existing log list of BioAdmin.

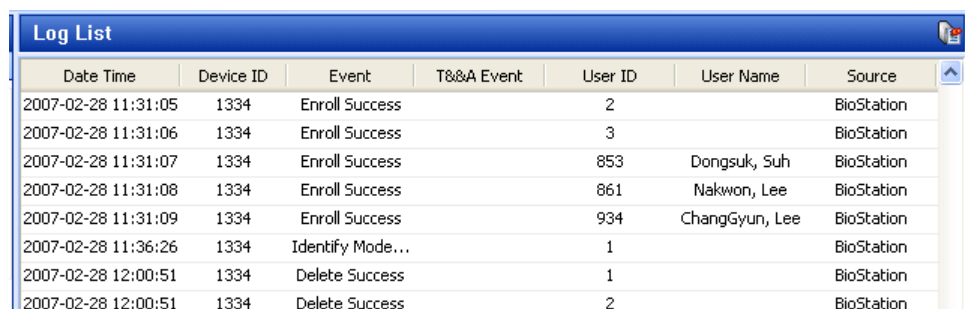

### 3.1.10. Step 10: Report

Select report menu to display report list on main window. You can specify company name, dept. name, user ID and user name for setting and select required type of

report such as daily report by setting period or individual report.

**Upload log** is a button to upload a log saved in device and **update report** button is a button which implements display prior to output listing a log uploaded device by date and individual. Lastly, view report is a button to preview a report. Press print button to print.

## 3.2. Quick start with BioEntry Plus

### 3.2.1. Step 1 : Hardware Installation

BioEntry Plus may set the network by using wired LAN. For the detail information of installation, please refer to the BEPlus Installation Guide.

Note: The LED color of BioEntry Plus can be changed by BioEntry Plus status. Please refer to the page 10 of “BioEntry Plus Install Guide V1.0” for further color status.

### 3.2.2. Step 2 : Search a New Device

- Run BioAdmin Software.
- Enter login ID and Password.
- Select “Device Management” at the Main Window.

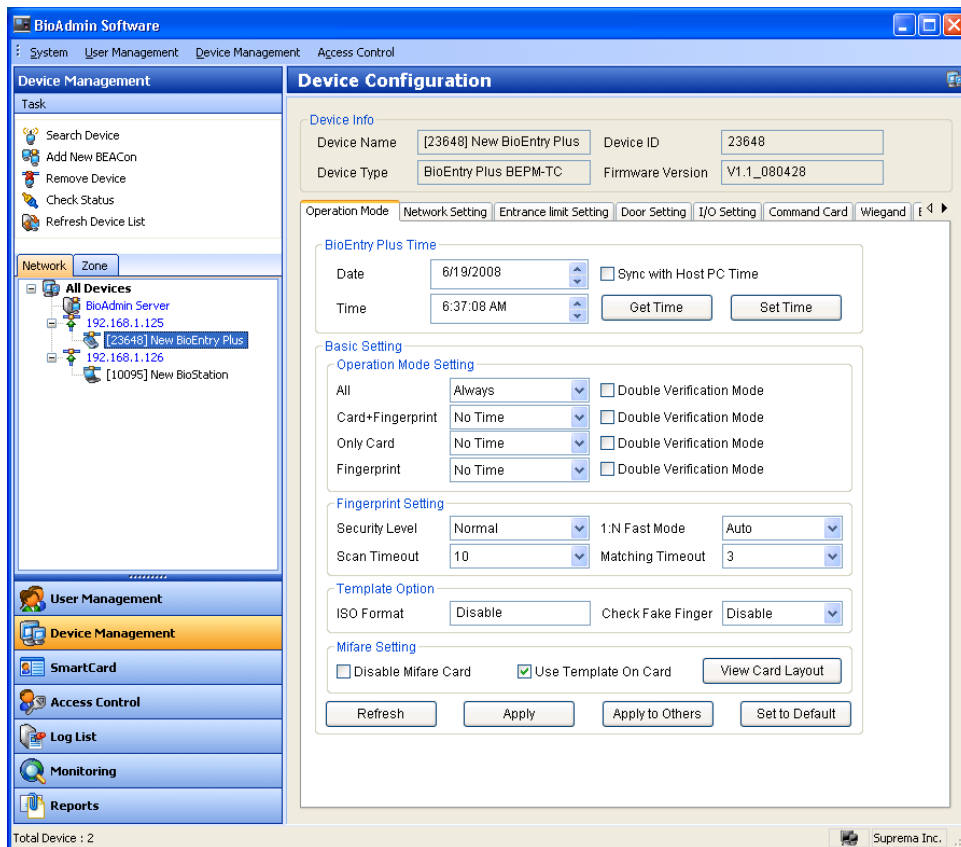

- BioEntry Plus connected to the server is automatically added to the list and also if selecting 'Refresh Device List', it shows the list of newly connected devices. Even though accessing BioEntry Plus to the server, it may take several minutes until it is actually connected to the server and listed on the window.

### 3.2.3. Step 3 : Connect a New Device

- Select "Device Management" at the Main Window.
- Select "Search Device" and click "Search BioEntry Plus".
- Check "UDP (BioEntry Plus)" and press "Search" button.
- If detected BioEntry Plus, press 'OK' button
- Select the detected BioEntry Plus and press 'OK' button again.

Note : BioEntry Plus supports DHCP function, so you can easily verify assigned IP address in your network, which can also distinguish as its own device ID. In case of static IP network environment, you can type your own



static IP address. For more than two static IP address, you have to register each one separately. After finishing registration, you need to type it at the network tab of the corresponding device..

### 3.2.4. Step 4 : User Management

- If clicking User Management menu, you can see User Management at the Main Window.

Note : User Data Information mainly divides by User Information and Fingerprint. User Information is consists of User ID, Name, Company, Department, Title, and Phone number. Fingerprint is mainly for fingerprint information of user.

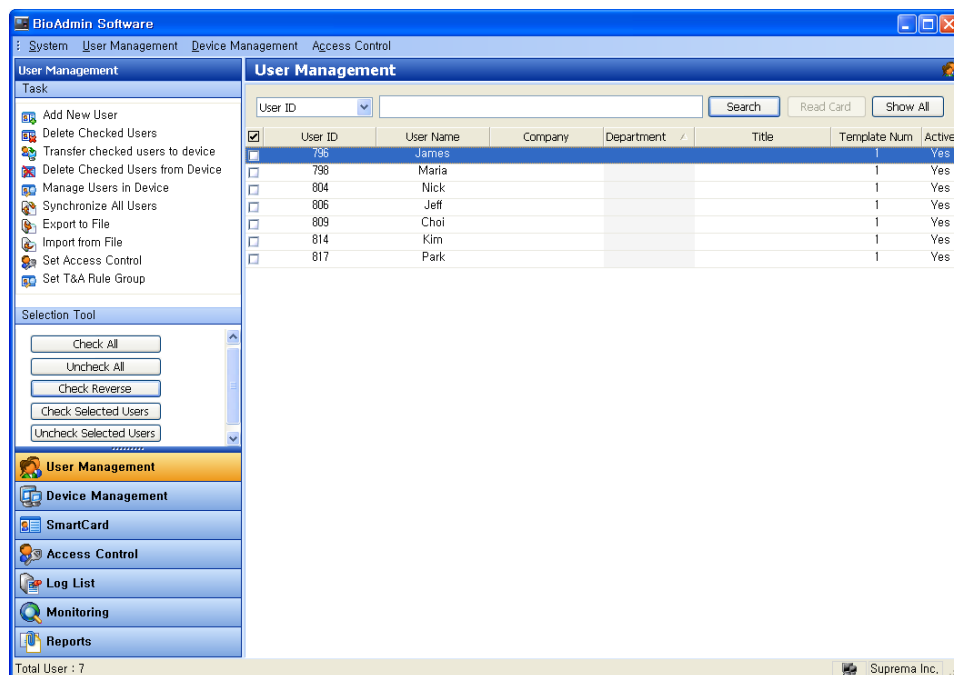

- Click “Add New User” to register new user..
- Type user information in the tab of User Data Information..

- 
- You can select your department & title using combo box.
- To add new company, department or title information, press button or type company, department, title in information input window.
- To save added information, press Close button.

- You can type phone, mobile, e-mail, gender, date of birth details and User Data Information will be indicated as Start Date, which can be configured Expiry Date of user.
- In case of applying access control, please check mark “Active” of Access Group Status and select group what you already generated.
- In addition, private password can be generated, which is used for password verification.
- Daily Limit is to make verification available of daily limitation. In case of setting timed APB, it will be possible to verify it again after at least one time verification.
- Please click Custom Fields to create more detailed user data information.
- Click fingerprint tab to register user's fingerprint information.
- The method of fingerprint registration is divided by two, via USB fingerprint scanner and BioEntry Plus device (Same as BioStation)
- The method via USB fingerprint scanner is following as:

The screenshot shows the 'User Data Information' dialog box with the 'Fingerprint' tab selected. The dialog has four tabs: 'User Information', 'Custom Fields', 'Fingerprint', and 'User Time Attendance Rule'. The 'Fingerprint' tab contains the following elements:

- Use Device as Enroll Station
- Device ID: [1058] New BioEntry Plus (dropdown) and Wiegand /Card ID Setup (button)
- 1:1 Security Level: BioStation/BioEntry Plus (dropdown) and Device Default (dropdown)
- BioEntry Smart/Pass: Device Default (dropdown)
- Smart Card / RF ID section:
  - Smart Card S/N: S/N:0 (text field)
  - RF: 000-0 (text field)
  - User ID: UserID:853 (text field)
  - Bypass Card
  - Buttons: Read Card, Write Card, Format Card, Verification Test
- 1st Template and 2nd Template sections:
  - Each has a  Duress checkbox and a large empty rectangular area for the fingerprint.
  - Buttons: Scan and Delete for each template.
- Bottom buttons: OK and Cancel.

- Press 'Scan' button and put your 1<sup>st</sup> fingerprint twice for 1<sup>st</sup> template.

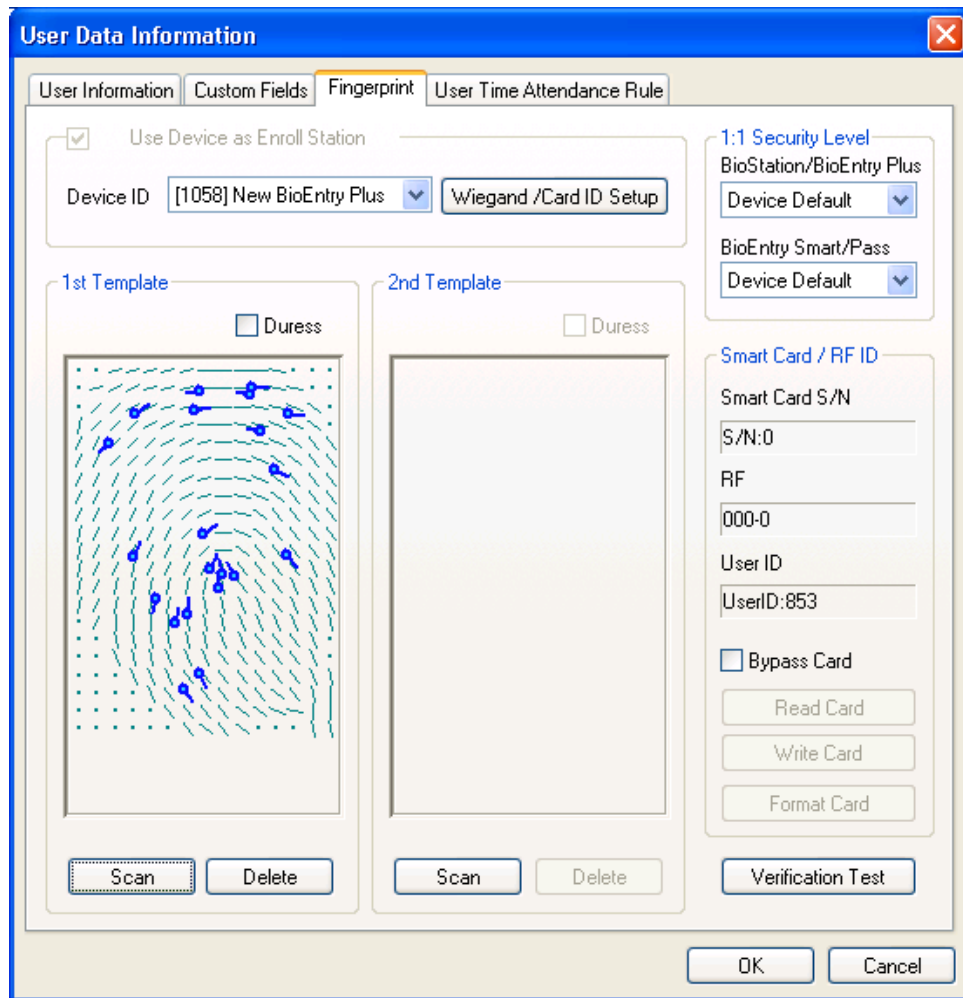

- Put your 2<sup>nd</sup> template same as 1<sup>st</sup> method above.

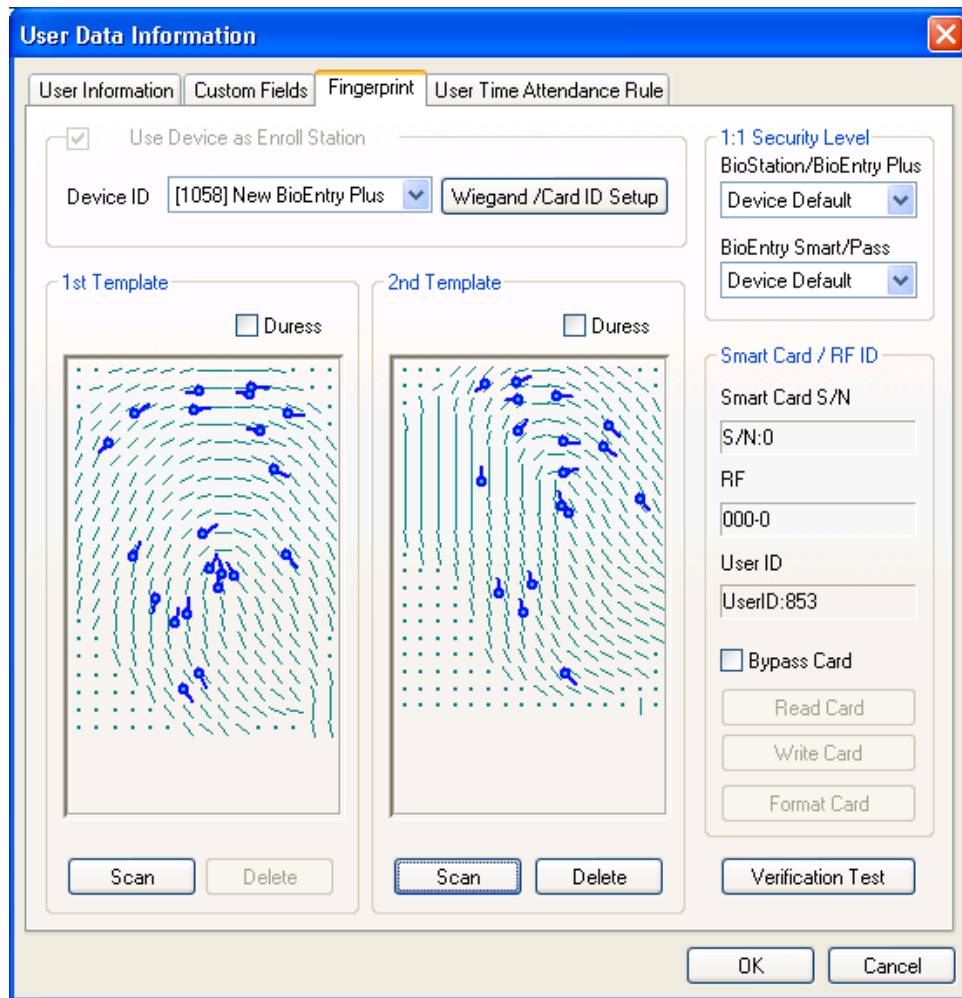

- The method via BioEntry Plus is following as:

The screenshot shows the 'User Data Information' dialog box with the 'Fingerprint' tab selected. The dialog has four tabs: 'User Information', 'Custom Fields', 'Fingerprint', and 'User Time Attendance Rule'. The 'Fingerprint' tab contains the following elements:

- Use Device as Enroll Station
- Device ID: [1058] New BioEntry Plus (dropdown) and Wiegand /Card ID Setup (button)
- 1:1 Security Level: BioStation/BioEntry Plus (dropdown) and Device Default (dropdown)
- BioEntry Smart/Pass: Device Default (dropdown)
- Smart Card / RF ID section:
  - Smart Card S/N: S/N:0 (text field)
  - RF: 000-0 (text field)
  - User ID: UserID:853 (text field)
  - Bypass Card
  - Buttons: Read Card, Write Card, Format Card
  - Verification Test (button)
- 1st Template and 2nd Template sections:
  - Each has a  Duress checkbox and a large empty rectangular area for fingerprint capture.
  - Buttons: Scan and Delete for each template.
- Bottom buttons: OK and Cancel.

- In case of stand-alone usage, check the registration using BioEntry Plus, press 'Scan' button, and put your finger twice to register 1<sup>st</sup> template.
- In case of more than two devices via networking, set BioEntry Plus ID, press 'Scan' button, and put your finger twice to register 1<sup>st</sup> template.

**User Data Information**

User Information Custom Fields **Fingerprint** User Time Attendance Rule

Use Device as Enroll Station

Device ID [1058] New BioEntry Plus Wiegand /Card ID Setup

**1:1 Security Level**  
BioStation/BioEntry Plus  
Device Default

BioEntry Smart/Pass  
Device Default

**Smart Card / RF ID**  
Smart Card S/N  
S/N:0  
RF  
000-0  
User ID  
UserID:853  
 Bypass Card  
Read Card  
Write Card  
Format Card  
Verification Test

**1st Template**  Duress  
Scan Delete

**2nd Template**  Duress  
Scan Delete

OK Cancel

- Please follow same procedure for 2<sup>nd</sup> template.



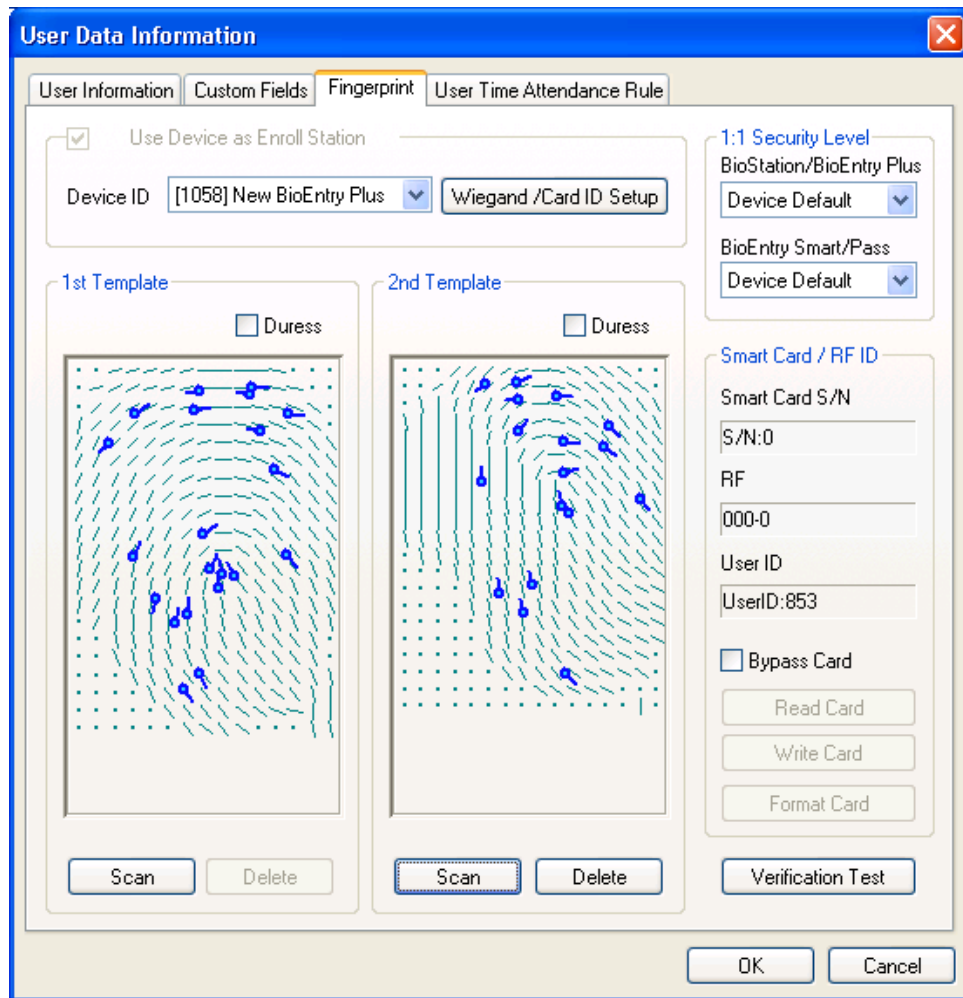

- Press 'OK' button for exit, then you can see the registered user data in the User Management window, which means that it was recorded in database of host PC.

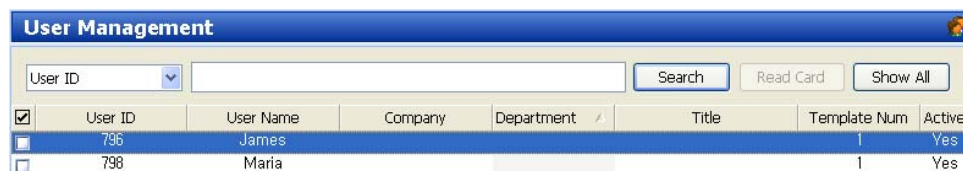

### 3.2.5. Step 5: Issue Mifare card

- In case of selecting BioStation Mifare / BioEntry Plus Mifare (2.4 Using Mifare Card), user Mifare card can be issued using BioStation Mifare.

- Double click the user on the “User Management”, then it will be appeared ‘User Data Information’.

Click Fingerprint tab on the ‘User Data Information’. Select Mifare card as PC USB smart card device and click ‘Write Card’ button.

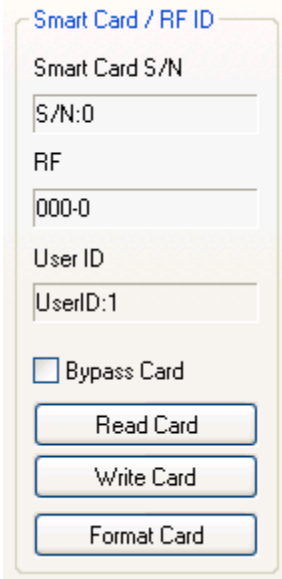

Smart Card / RF ID

Smart Card S/N

S/N:0

RF

000-0

User ID

UserID:1

Bypass Card

Read Card

Write Card

Format Card

- ‘Site Key’ window will be appeared for the first time use. Please type correct site key and press OK button to complete issue process (in case of ‘Blank’ type, the default value will be used)

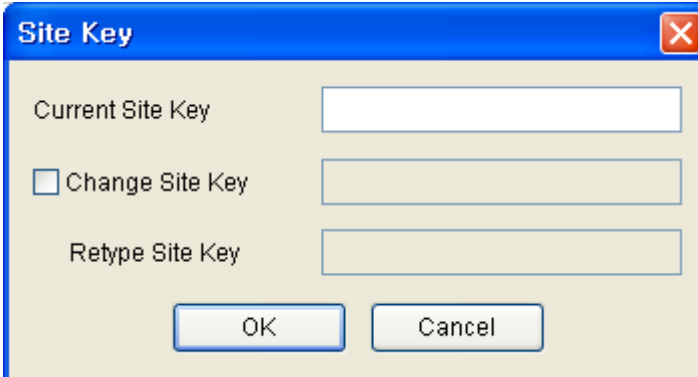

Site Key

Current Site Key

Change Site Key

Retype Site Key

OK Cancel

- Smart Card information for the stored user data on the “User Management”.

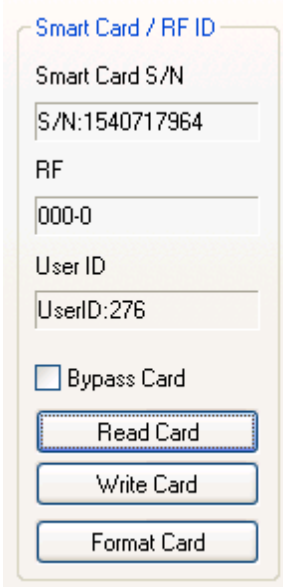

The image shows a software window titled "Smart Card / RF ID". It contains several input fields and buttons. The "Smart Card S/N" field has the value "S/N:1540717964". The "RF" field has the value "000-0". The "User ID" field has the value "UserID:276". There is a checkbox labeled "Bypass Card" which is currently unchecked. Below the checkbox are three buttons: "Read Card", "Write Card", and "Format Card".

This Smart Card S/N is read only when issued for using PC USB smart card device, BioStation Mifare or BioEntry Plus Mifare can be used through 'Read Card'.

Select “Smart Card” menu, then you will see the added smart card list.

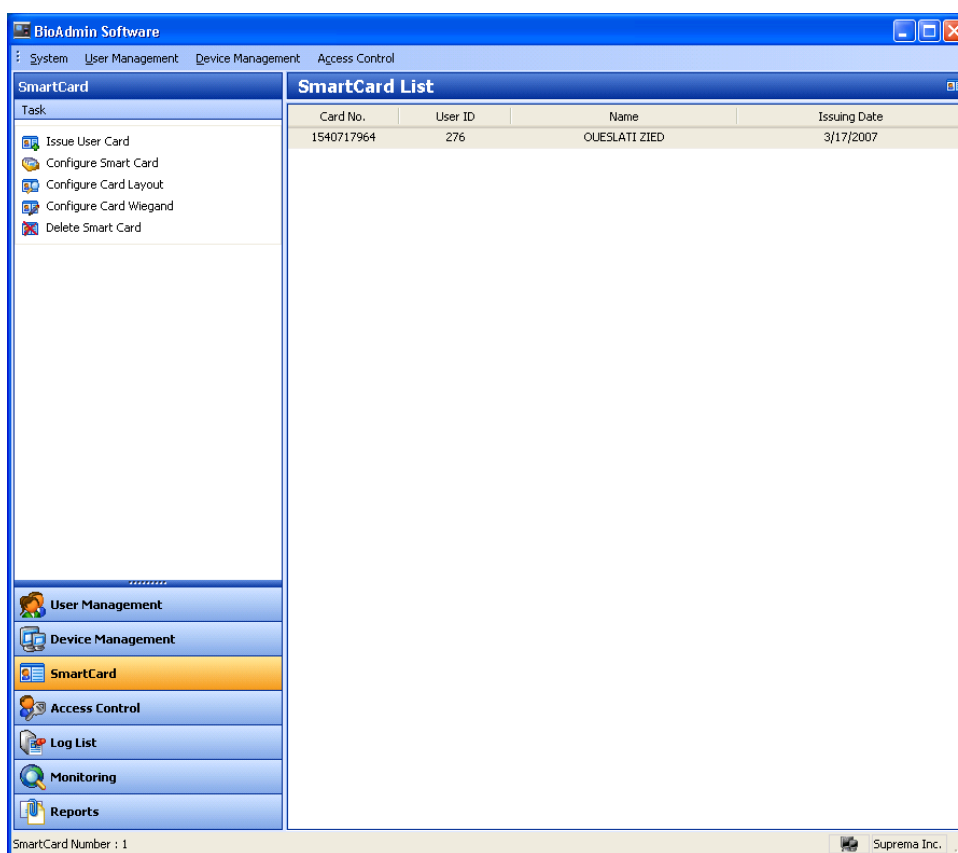

### 3.2.6. Step 6 : User Time Attendance Rule

By applying already registered 'User time attendance rule group' to the user, it will be used for a reference when generated a report.

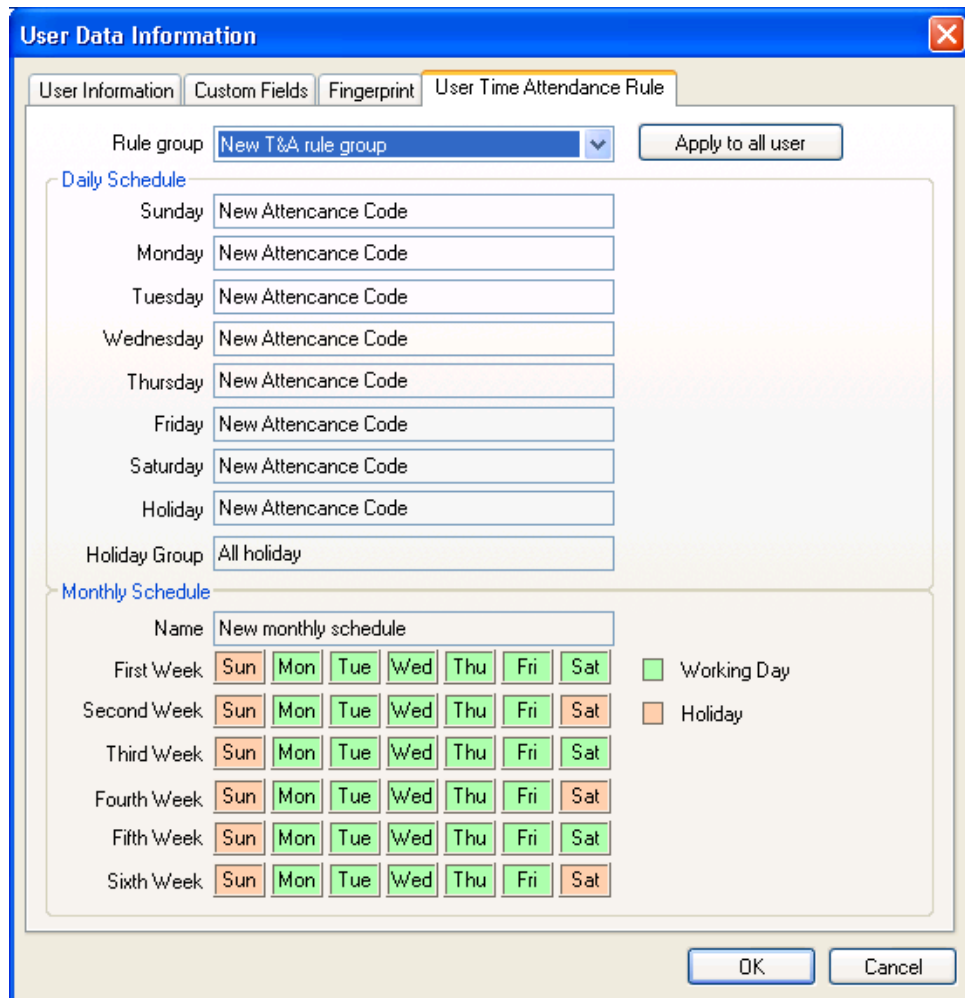

3.2.7. Step 7 : User registration with “Transfer Checked Users to Device” menu

‘Transfer checked users to device’ is used for transferring user database from host PC to BioEntry Plus device, which are User ID, Fingerprint, Access Group, Admin Level, and so on.

- Check registered user

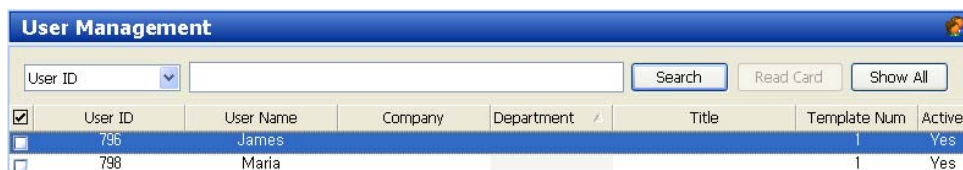

- Click “Transfer checked users to device” button and check mark to transfer.

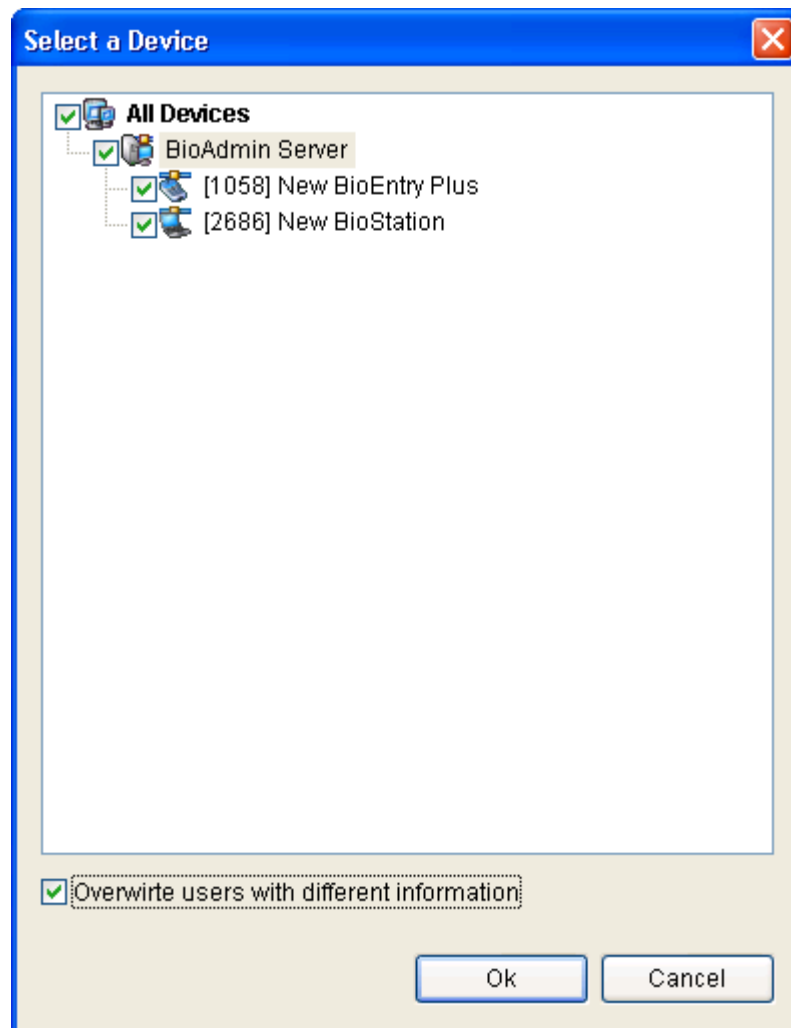

- Press “Manage Users in Device” button and click the device. If the area of user information is marked in yellow color, it is successfully transferred.

- 

### 3.2.8. Step 8 : Monitoring

- Event list windows will be appeared if selecting “Monitoring” menu.
- Select “Setup Monitoring” and double-click each event of Real-Time Monitoring to change its status as Yes or No/.
- Press ‘OK’ button.
- Press “Start Monitoring” to start real-time event.

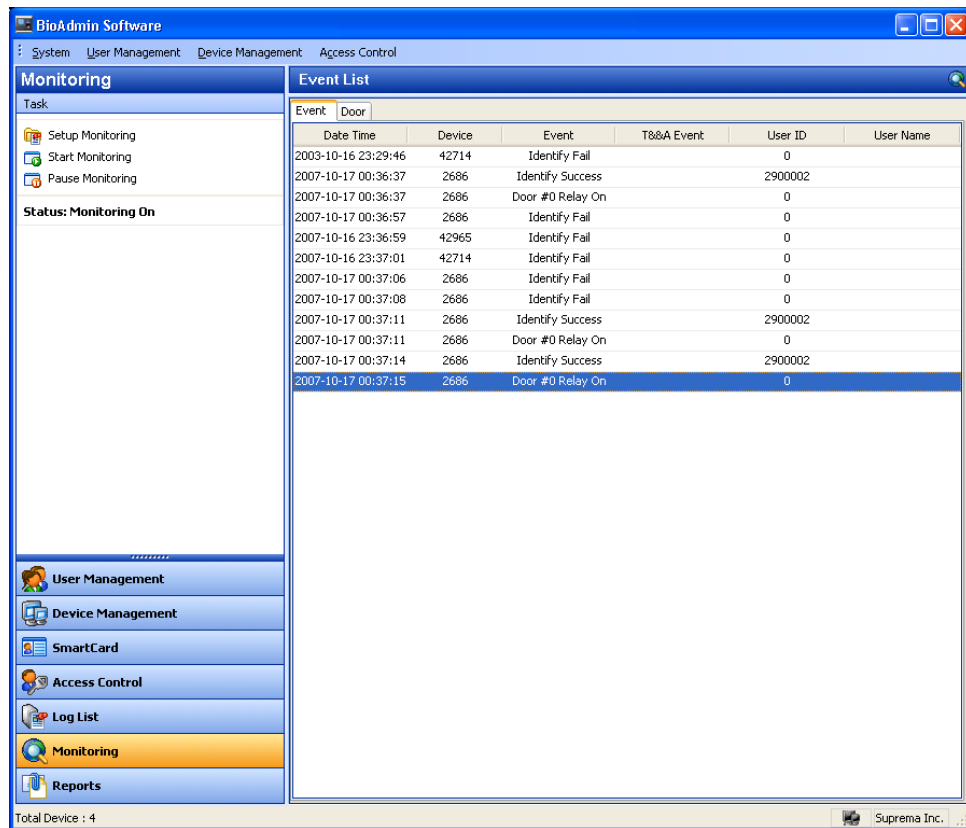

- Door : If there are already door setting, you can see “Door” monitoring shown as below figure, which can be Open Door, Close Door, and Release Alarm.
  - Open Door : Apply to actual device
  - Close Door : Apply to actual device
  - Release Alarm : Does not apply to actual device, but only in PC

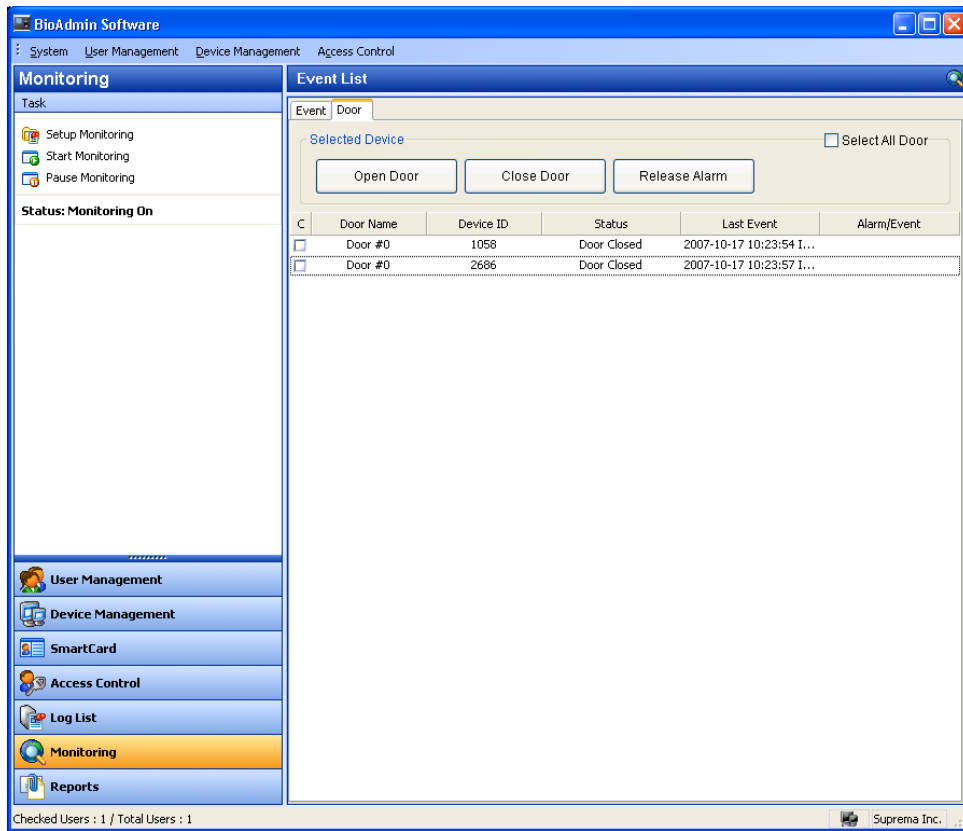

- 

### 3.2.9. Step 9 : Log List

- If selecting Log List menu, it will be appeared in the main window.
- Click “Get Recent Logs / Auto Upload”, select a device, press OK button, then you can see event log data added at log database of host PC.

The screenshot shows the 'Log List' window with a table of event logs. The table has columns: Date Time, Device ID, Event, T&&A Event, User ID, User Name, and Source.

Date Time	Device ID	Event	T&&A Event	User ID	User Name	Source
2007-02-28 11:31:05	1334	Enroll Success		2		BioStation
2007-02-28 11:31:06	1334	Enroll Success		3		BioStation
2007-02-28 11:31:07	1334	Enroll Success		853	Dongsuk, Suh	BioStation
2007-02-28 11:31:08	1334	Enroll Success		861	Nakwon, Lee	BioStation
2007-02-28 11:31:09	1334	Enroll Success		934	ChangGyun, Lee	BioStation
2007-02-28 11:36:26	1334	Identify Mode...		1		BioStation
2007-02-28 12:00:51	1334	Delete Success		1		BioStation
2007-02-28 12:00:51	1334	Delete Success		2		BioStation

-



### 3.2.10. Step 10 : Reports

- Select report menu to display report list on main window. You can specify company name, dept. name, user ID and user name for setting and select required type of report such as daily report by setting period or individual report.
- **Upload log** is a button to upload a log saved in device and **update report** button is a button which implements display prior to output listing a log uploaded device by date and individual. Lastly, **view report** is a button to preview a report. Press print button to print.
- 

## 3.3. Quick start with BioLite Net

### 3.3.1. Step 1 : Hardware Installation

BioLite Net may set the network by using wired LAN. For the detail information of installation, please refer to the BioLite Net User Guide.

### 3.3.2. Step 2 : Search a New Device

- Run BioAdmin Software.
- Enter login ID and Password.
- Select "Device Management" at the Main Window.

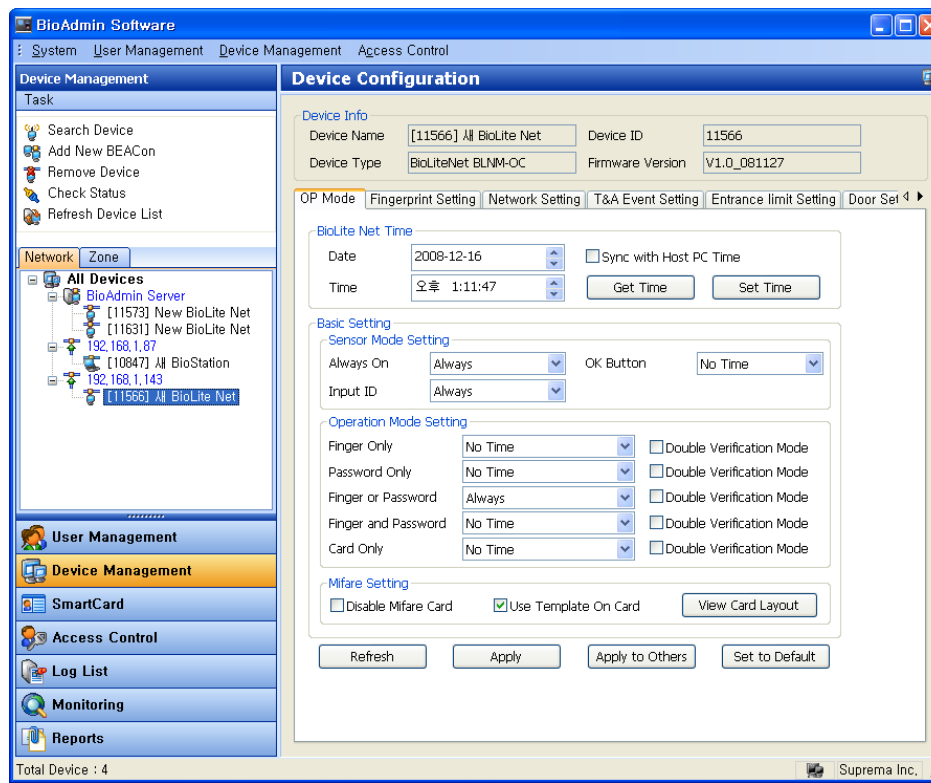

- BioLite Net connected to the server is automatically added to the list and also if selecting 'Refresh Device List', it shows the list of newly connected devices. Even though accessing BioLite Net to the server, it may take several minutes until it is actually connected to the server and listed on the window.

### 3.3.3. Step 3 : Connect a New Device

- Select "Device Management" at the Main Window.
- Select "Search Device" and click "Search BioLite Net".
- Check "UDP (BioEntry Plus / BioLite Net)" and press "Search" button.
- If detected BioLite Net, press 'OK' button
- Select the detected BioLite Net and press 'OK' button again.

Note : BioLite Net supports DHCP function, so you can easily verify assigned IP address in your network, which can also distinguish as its own device ID. In case of static IP network environment, you can type your own static IP address. For more than two static IP address, you have to register each one separately. After finishing registration, you need to type it at the network tab of

the corresponding device..

### 3.3.4. Step 4 : User Management

- If clicking User Management menu, you can see User Management at the Main Window.

Note : User Data Information mainly divides by User Information and Fingerprint. User Information is consists of User ID, Name, Company, Department, Title, and Phone number. Fingerprint is mainly for fingerprint information of user.

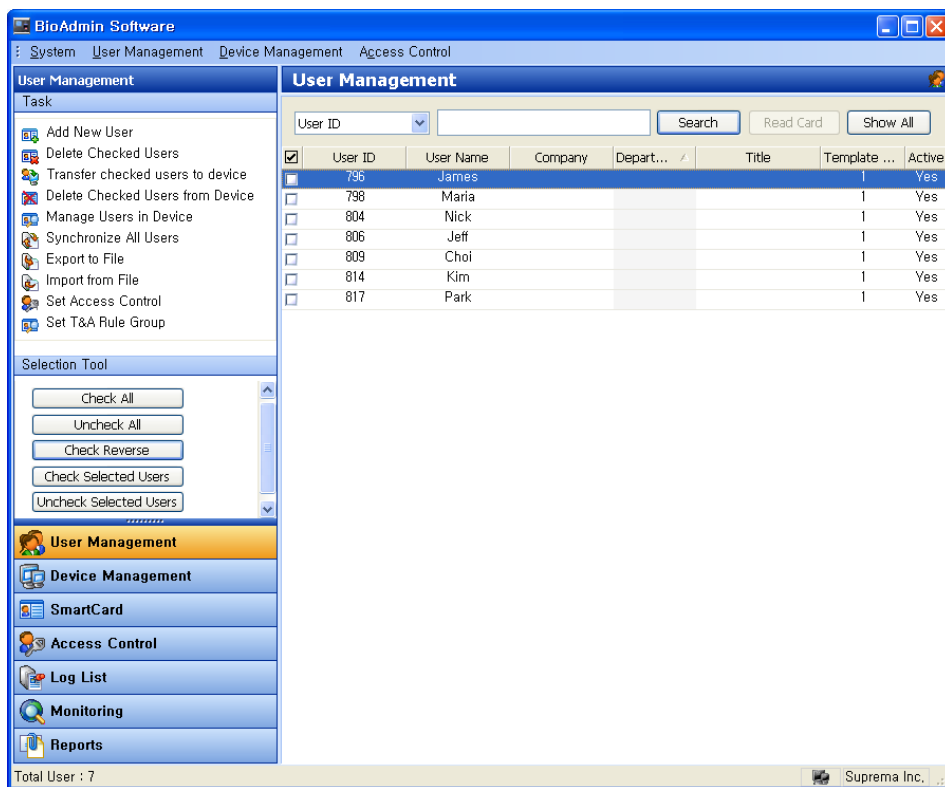

- Click "Add New User" to register new user..
- Type user information in the tab of User Data Information..

- 
- You can select your department & title using combo box.
- To add new company, department or title information, press button or type company, department, title in information input window.
- To save added information, press Close button.

- You can type phone, mobile, e-mail, gender, date of birth details and User Data Information will be indicated as Start Date, which can be configured Expiry Date of user.
- In case of applying access control, please check mark “Active” of Access Group Status and select group what you already generated.
- In addition, private password can be generated, which is used for password verification.
- Daily Limit is to make verification available of daily limitation. In case of setting timed APB, it will be possible to verify it again after at least one time verification.
- Please click Custom Fields to create more detailed user data information.
- Click fingerprint tab to register user's fingerprint information.
- The method of fingerprint registration is divided by two, via USB fingerprint scanner and BioLite Net device (Same as BioStation)
- The method via USB fingerprint scanner is following as:

The screenshot shows the 'User Data Information' dialog box with the 'Fingerprint' tab selected. The dialog has four tabs: 'User Information', 'Custom Fields', 'Fingerprint', and 'User Time Attendance Rule'. The 'Fingerprint' tab contains the following elements:

- Use Device as Enroll Station
- Device ID: [1058] New BioEntry Plus (dropdown) and Wiegand /Card ID Setup (button)
- 1:1 Security Level: BioStation/BioEntry Plus (dropdown) and Device Default (dropdown)
- BioEntry Smart/Pass: Device Default (dropdown)
- Smart Card / RF ID section:
  - Smart Card S/N: S/N:0 (text field)
  - RF: 000-0 (text field)
  - User ID: UserID:853 (text field)
  - Bypass Card
  - Buttons: Read Card, Write Card, Format Card, Verification Test
- Two fingerprint template areas:
  - 1st Template:  Duress, Scan button, Delete button
  - 2nd Template:  Duress, Scan button, Delete button
- Bottom buttons: OK, Cancel

- Press 'Scan' button and put your 1<sup>st</sup> fingerprint twice for 1<sup>st</sup> template.

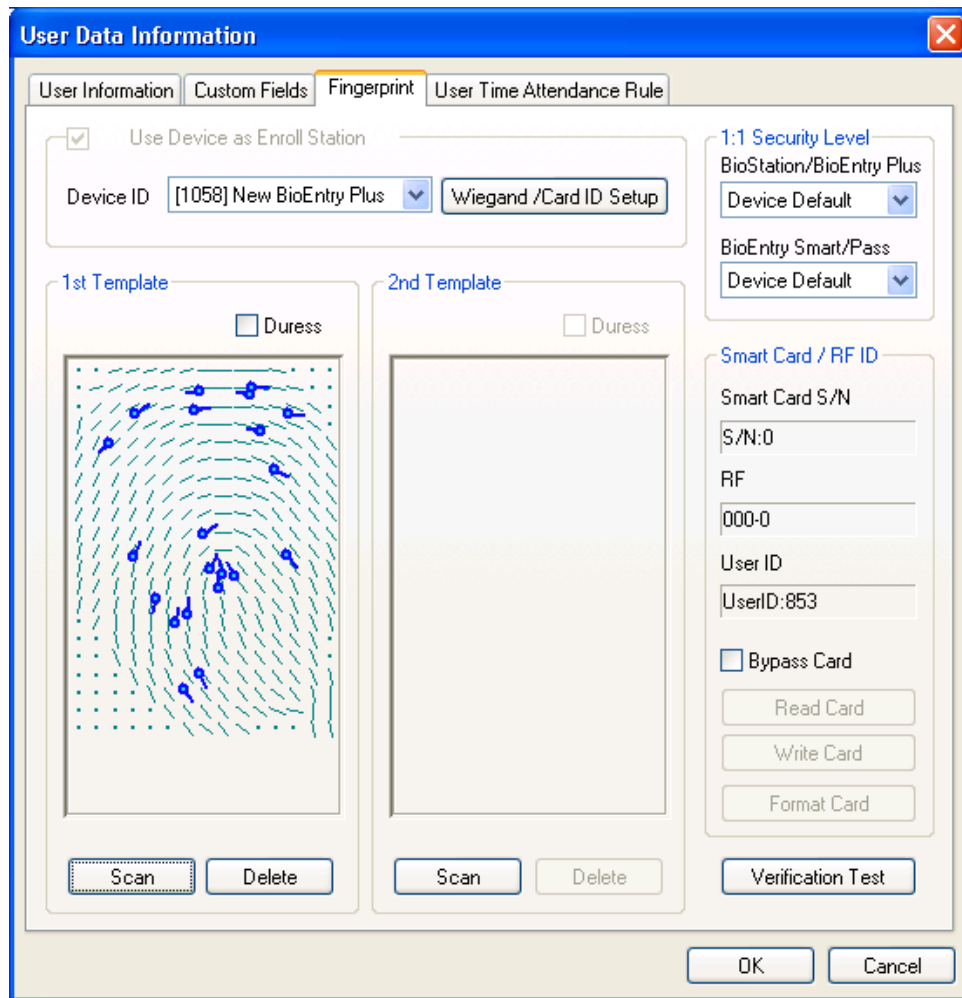

- Put your 2<sup>nd</sup> template same as 1<sup>st</sup> method above.

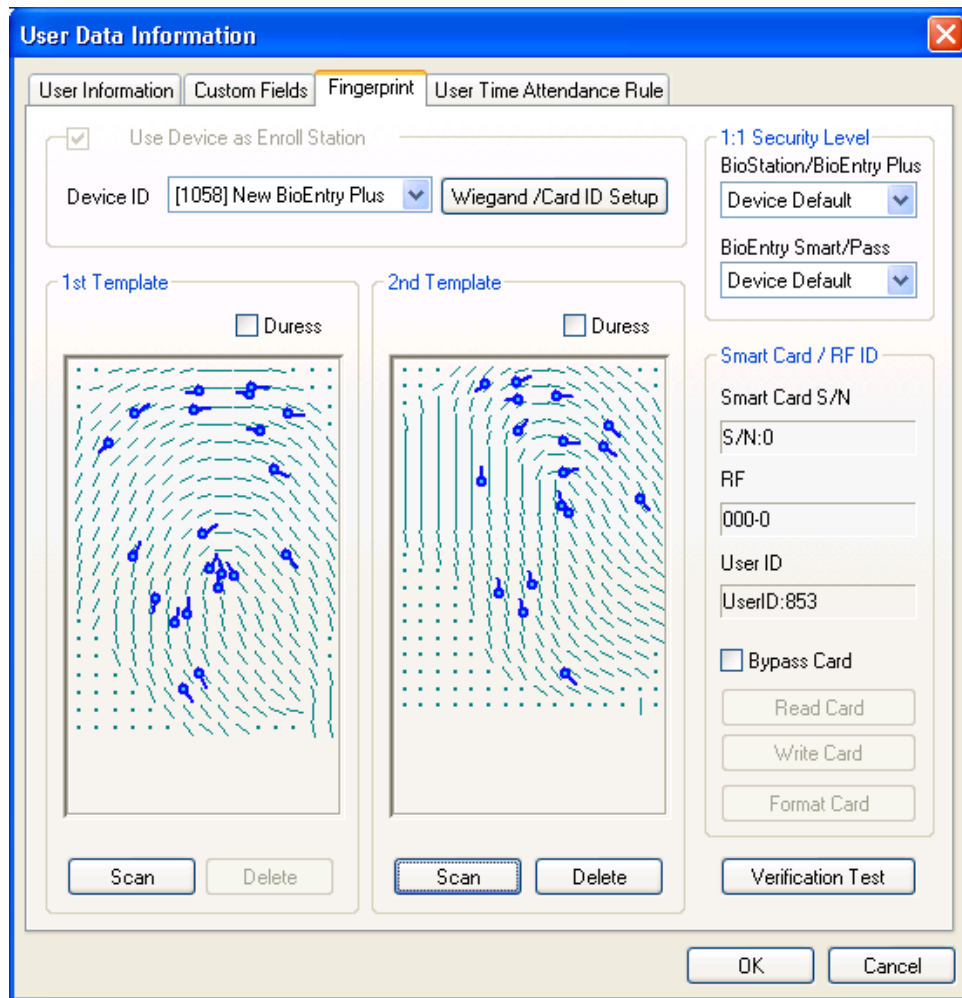

- The method via BioLite Net is following as:



The screenshot shows the 'User Data Information' dialog box with the 'Fingerprint' tab selected. The dialog has four tabs: 'User Information', 'Custom Fields', 'Fingerprint', and 'User Time Attendance Rule'. The 'Fingerprint' tab contains the following elements:

- Use Device as Enroll Station
- Device ID: [1058] New BioEntry Plus (dropdown) and Wiegand /Card ID Setup (button)
- 1:1 Security Level: BioStation/BioEntry Plus (dropdown) and Device Default (dropdown)
- BioEntry Smart/Pass: Device Default (dropdown)
- Smart Card / RF ID section:
  - Smart Card S/N: S/N:0 (text field)
  - RF: 000-0 (text field)
  - User ID: UserID:853 (text field)
  - Bypass Card
  - Buttons: Read Card, Write Card, Format Card, Verification Test
- 1st Template and 2nd Template sections:
  - Each has a  Duress checkbox and a large empty rectangular area for fingerprint capture.
  - Buttons: Scan, Delete (for each template)
- Bottom buttons: OK, Cancel

- In case of stand-alone usage, check the registration using BioLite Net, press 'Scan' button, and put your finger twice to register 1<sup>st</sup> template.
- In case of more than two devices via networking, set BioLite Net ID, press 'Scan' button, and put your finger twice to register 1<sup>st</sup> template.

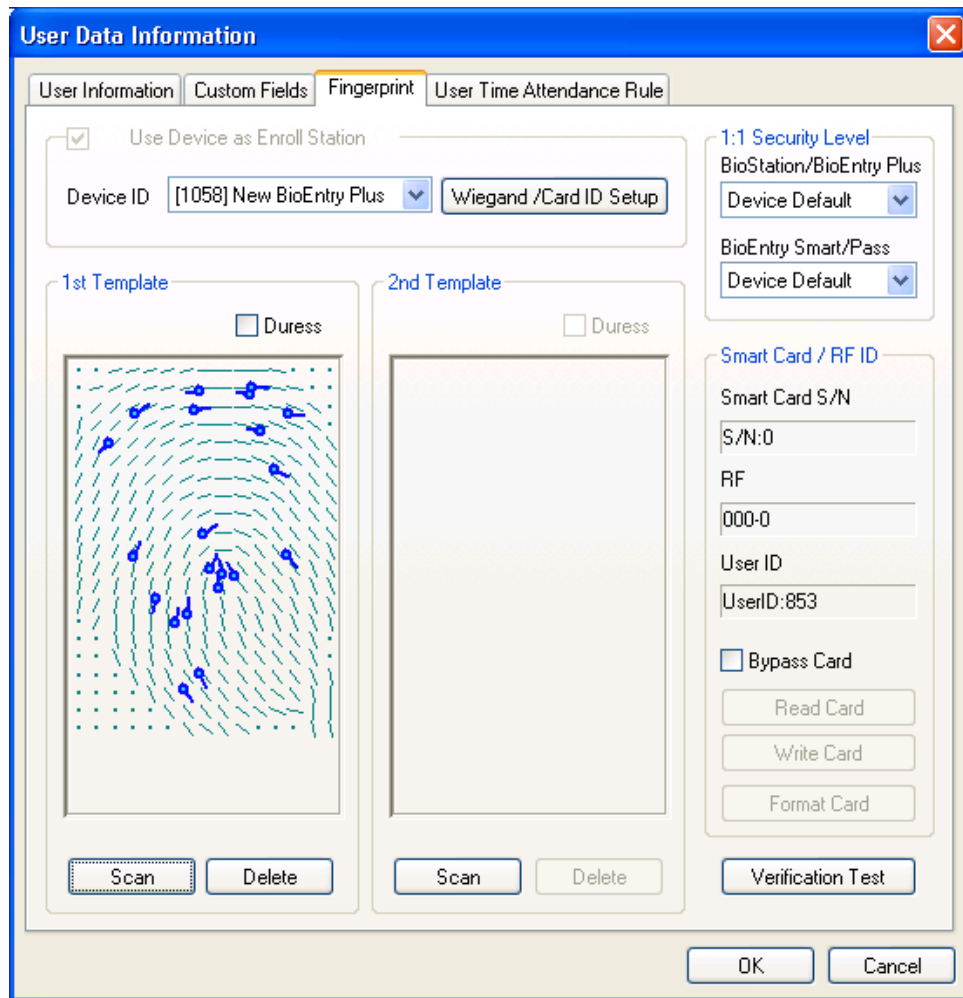

- Please follow same procedure for 2<sup>nd</sup> template.

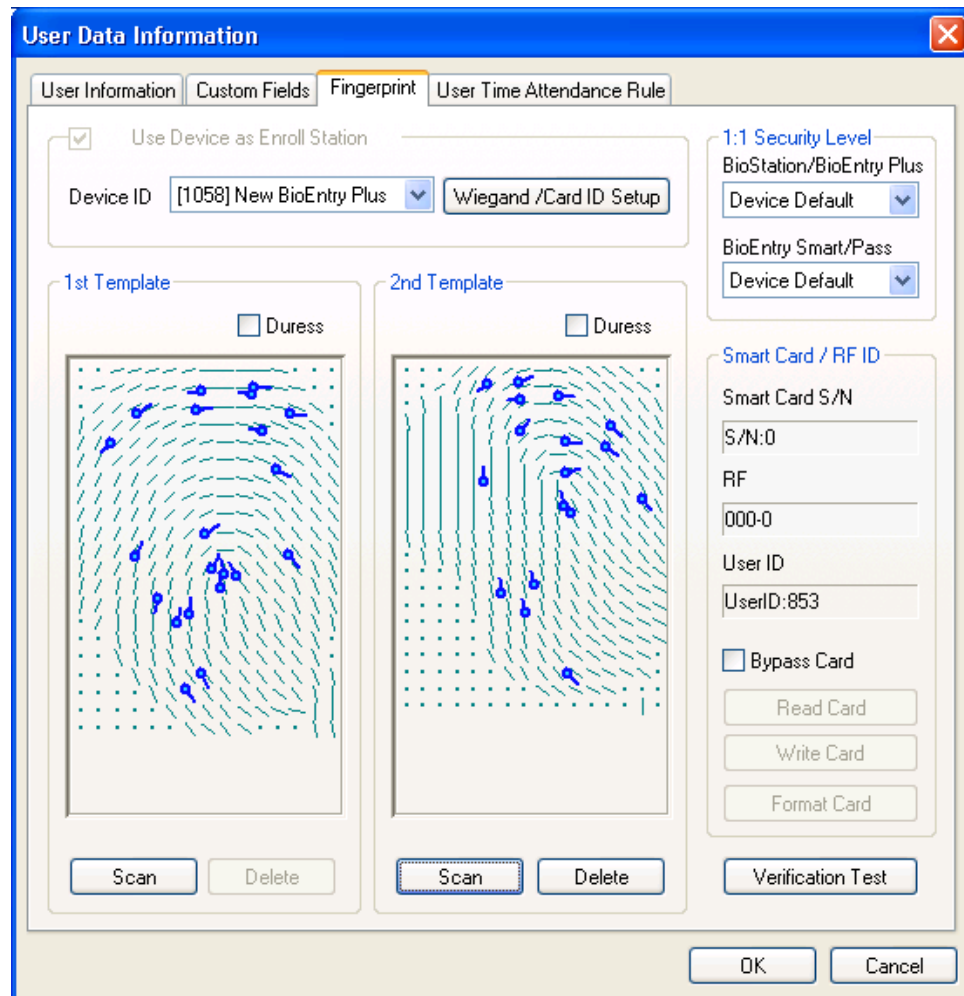

- Press 'OK' button for exit, then you can see the registered user data in the User Management window, which means that it was recorded in database of host PC.

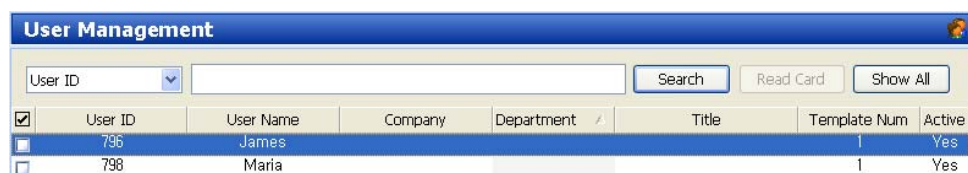

### 3.3.5. Step 5: Issue Mifare card

- In case of selecting BioStation Mifare / BioEntry Plus Mifare (2.4 Using Mifare Card), user Mifare card can be issued using BioLite Net Mifare.

- Double click the user on the “User Management”, then it will be appeared ‘User Data Information’.

Click Fingerprint tab on the ‘User Data Information’. Select Mifare card as PC USB smart card device and click ‘Write Card’ button.

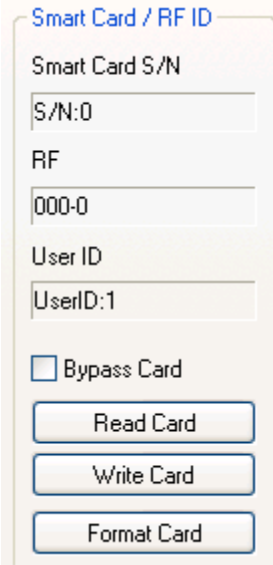

Smart Card / RF ID

Smart Card S/N

S/N:0

RF

000-0

User ID

UserID:1

Bypass Card

Read Card

Write Card

Format Card

- ‘Site Key’ window will be appeared for the first time use. Please type correct site key and press OK button to complete issue process (in case of ‘Blank’ type, the default value will be used)

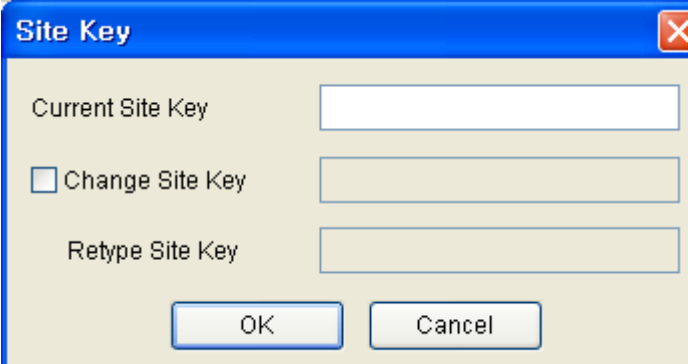

Site Key

Current Site Key

Change Site Key

Retype Site Key

OK Cancel

- Smart Card information for the stored user data on the “User Management”.

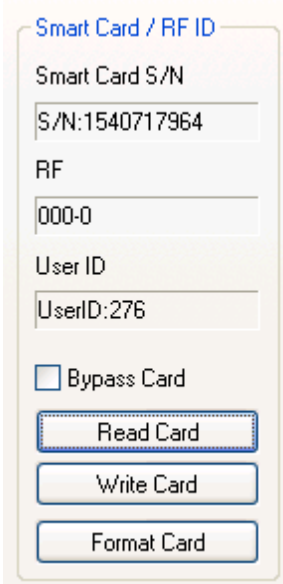

Smart Card / RF ID

Smart Card S/N  
S/N:1540717964

RF  
000-0

User ID  
UserID:276

Bypass Card

Read Card

Write Card

Format Card

This Smart Card S/N is read only when issued for using PC USB smart card device, BioStation Mifare, BioEntry Plus Mifare, or BioLite Net Mifare can be used through ‘Read Card’.

Select “Smart Card” menu, then you will see the added smart card list.

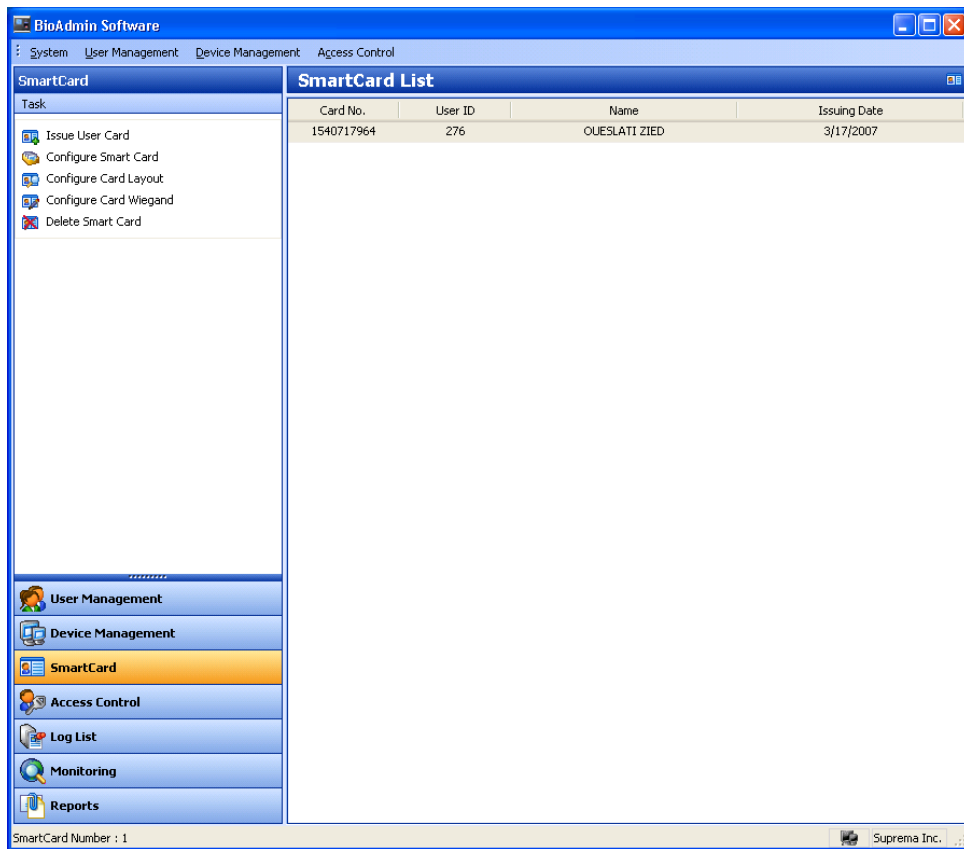

### 3.3.6. Step 6 : User Time Attendance Rule

By applying already registered 'User time attendance rule group' to the user, it will be used for a reference when generated a report.

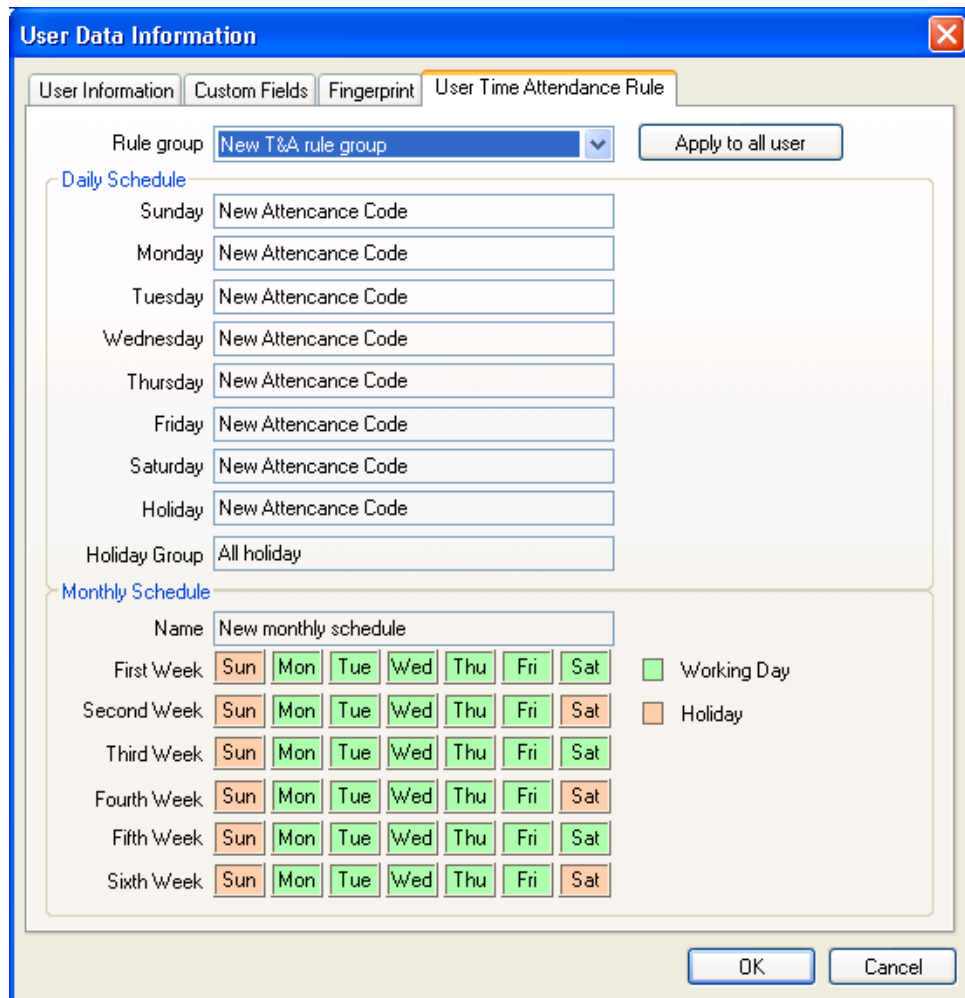

3.3.7. Step 7 : User registration with “Transfer Checked Users to Device” menu

‘Transfer checked users to device’ is used for transferring user database from host PC to BioLite Net device, which are User ID, Fingerprint, Access Group, Admin Level, and so on.

- Check registered user

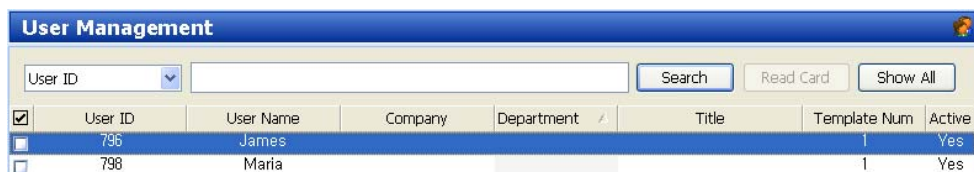

- Click “Transfer checked users to device” button and check mark to transfer.

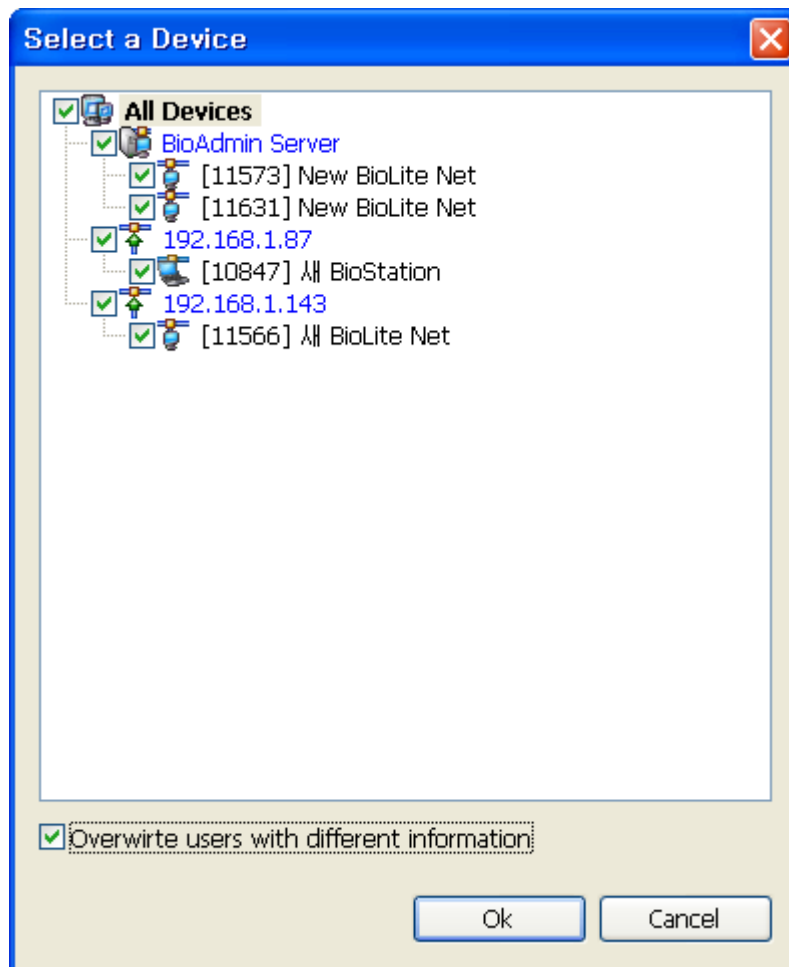

- Press “Manage Users in Device” button and click the device. If the area of user information is marked in yellow color, it is successfully transferred.

- 

### 3.3.8. Step 8 : Monitoring

- Event list windows will be appeared if selecting “Monitoring” menu.
- Select “Setup Monitoring” and double-click each event of Real-Time Monitoring to change its status as Yes or No/.
- Press ‘OK’ button.
- Press “Start Monitoring” to start real-time event.



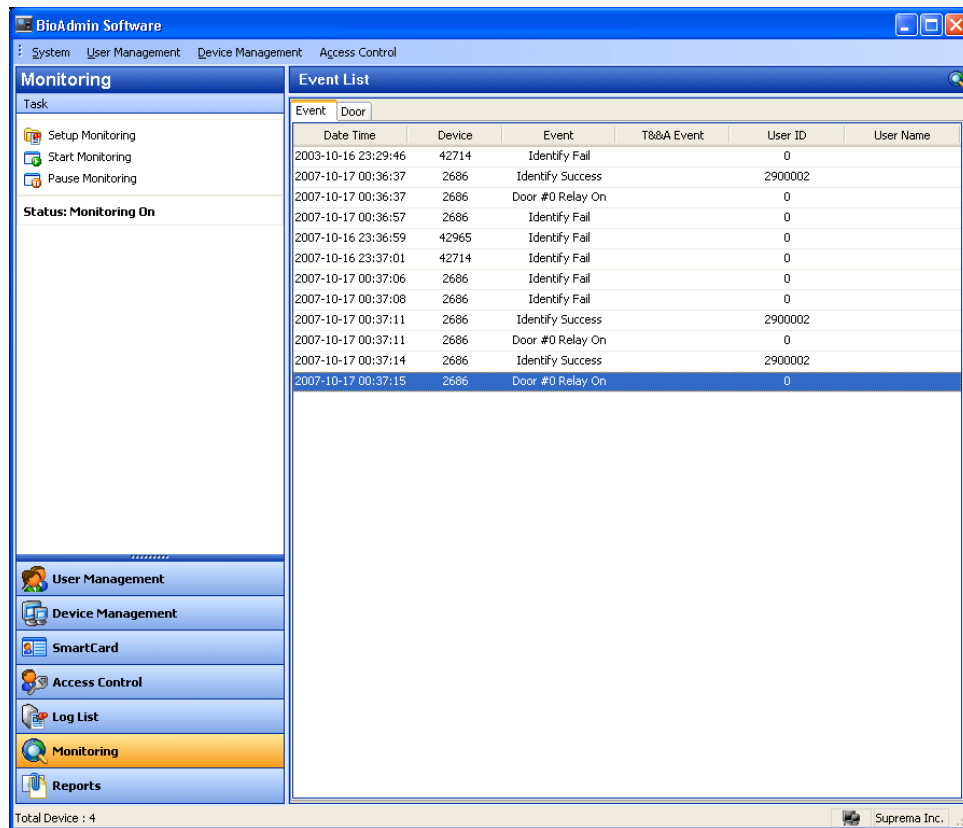

- Door : If there are already door setting, you can see “Door” monitoring shown as below figure, which can be Open Door, Close Door, and Release Alarm.
  - Open Door : Apply to actual device
  - Close Door : Apply to actual device
  - Release Alarm : Does not apply to actual device, but only in PC

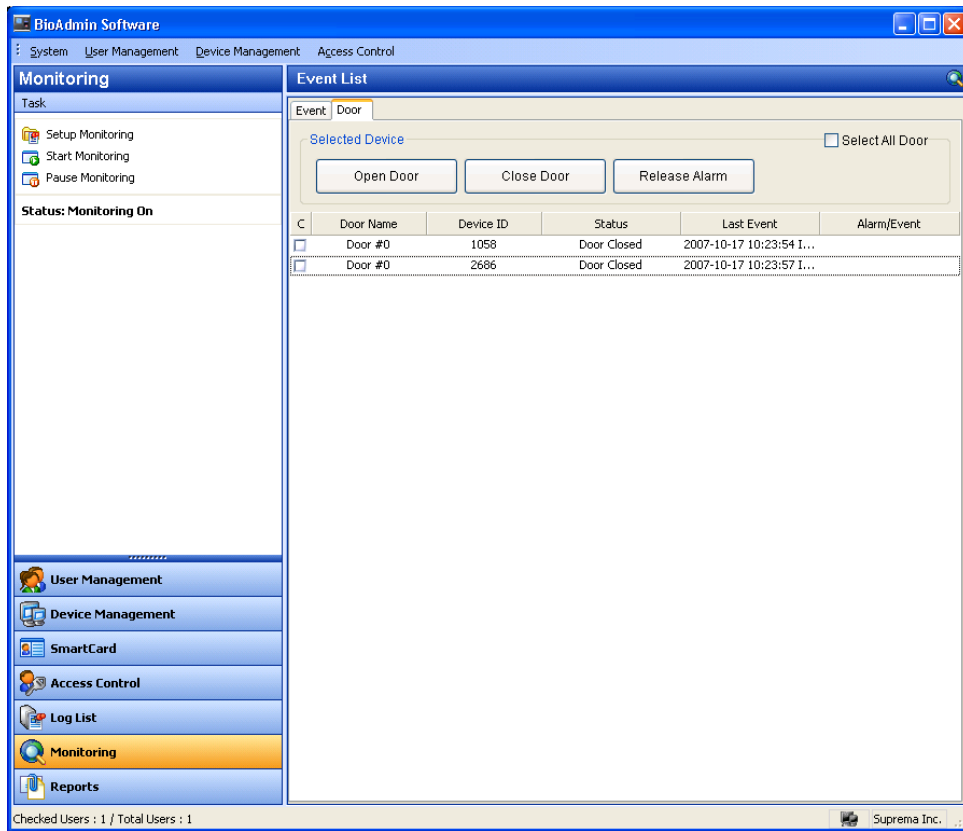

- 

### 3.3.9. Step 9 : Log List

- If selecting Log List menu, it will be appeared in the main window.
- Click “Get Recent Logs / Auto Upload”, select a device, press OK button, then you can see event log data added at log database of host PC.

The screenshot shows the 'Log List' window with a table of event logs. The table has columns: Date Time, Device ID, Event, T&&A Event, User ID, User Name, and Source.

Date Time	Device ID	Event	T&&A Event	User ID	User Name	Source
2007-02-28 11:31:05	1334	Enroll Success		2		BioStation
2007-02-28 11:31:06	1334	Enroll Success		3		BioStation
2007-02-28 11:31:07	1334	Enroll Success		853	Dongsuk, Suh	BioStation
2007-02-28 11:31:08	1334	Enroll Success		861	Nakwon, Lee	BioStation
2007-02-28 11:31:09	1334	Enroll Success		934	ChangGyun, Lee	BioStation
2007-02-28 11:36:26	1334	Identify Mode...		1		BioStation
2007-02-28 12:00:51	1334	Delete Success		1		BioStation
2007-02-28 12:00:51	1334	Delete Success		2		BioStation

-

### 3.3.10. Step 10 : Reports

- Select report menu to display report list on main window. You can specify company name, dept. name, user ID and user name for setting and select required type of report such as daily report by setting period or individual report.
- **Upload log** is a button to upload a log saved in device and **update report** button is a button which implements display prior to output listing a log uploaded device by date and individual. Lastly, **view report** is a button to preview a report. Press print button to print.

## 3.4. Quick start with BioEntry Smart

This section describes the basic procedures to operate BioEntry Smart using a USB fingerprint scanner and smart card device as its enrollment device.

### 3.4.1. Step 1: Hardware installation

In this hardware configuration, the device is not connected to the host PC, but to an external controller via Wiegand interface. It is assumed that the controller supports the standard 26 bit Wiegand format as default on BioEntry device. Connect the device with the controller as shown on the following configuration.

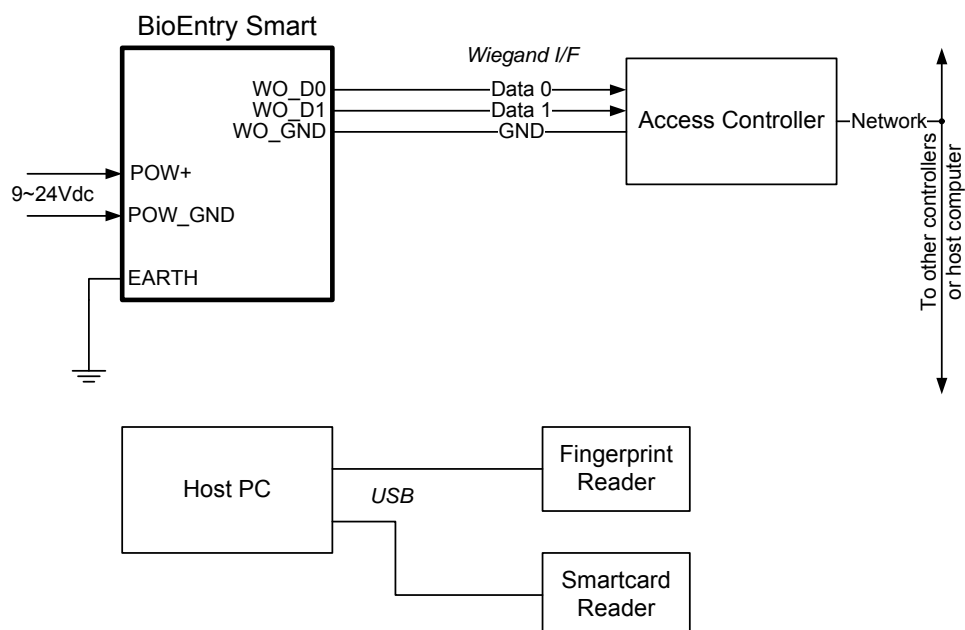

For more details on the installation, refer to the BioEntry Installation manual or BEACon Operation Manual.

### 3.4.2. Step 2: Enroll user

- Run BioAdmin software.
- Enter Login ID and password. By factory default, the initial Login ID is “**admin**” and the password is blank.
- Select **User Management** on the main menu, then the user management page appears on the main window.

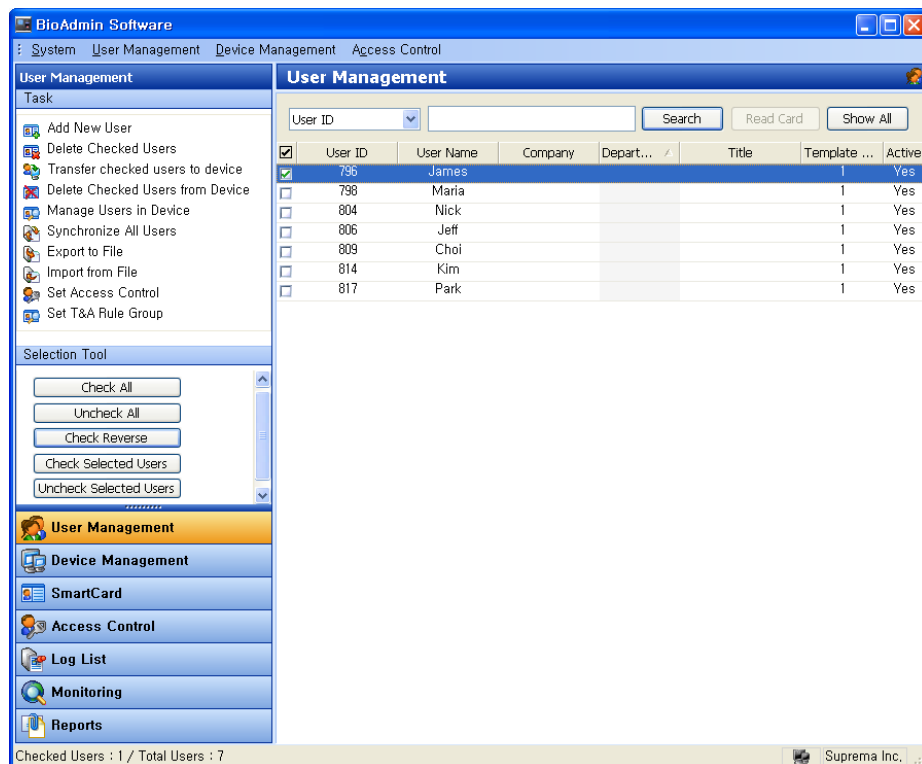

- Select the **Add New User** menu on the task window, then the pop-up window appears

**User Data Information**

User Information | Custom Fields | Fingerprint | User Time Attendance Rule

**Basic Personal Information**

User ID: 1

Name:

Company: None

Department: None

Title: None

**Details**

Phone:

Mobile:

E-Mail:

Gender: Male

Date of Birth: 10/16/2007

Start Date: 1/ 1/1970

Expiry Date: 12/31/2030  0 h

**Access Group**

Status:  Active

Group 1: Full Access

Group 2: None

Group 3: None

Group 4: None

**Entrance Limitation (BioStation)**

Daily Limit: 0 (0:00~23:59)

Timed APB: 0 Minute

**Other Information**

Password:  BST Admin Level: Normal User

- Enter the **user information** on the User Information tab.

**User Data Information**

User Information Custom Fields Fingerprint User Time Attendance Rule

**Basic Personal Information**

User ID: 853

Name: Dongsuk, Suh

Company: Suprema

Department: R&D

Title: Manager

**Details**

Phone: 012-345-6789

Mobile: 098-765-4321

E-Mail: dsuck@anymail

Gender: Male

Date of Birth: 6/14/1970

Start Date: 1/ 1/1970

Expiry Date: 12/31/2030  0 h

**Access Group**

Status:  Active

Group 1: Full Access

Group 2: None

Group 3: None

Group 4: None

**Entrance Limitation (BioStation)**

Daily Limit: 0 (0:00~23:59)

Timed APB: 0 Minute

**Other Information**

Password:

BST Admin Level: Normal User

- Especially, you can select the Company, Department, and Title on the drag down menu.
- To add new Company, Department, or Title information, press  button. After entering the required information, press **Add** button. Press **Save** button to save the added information.

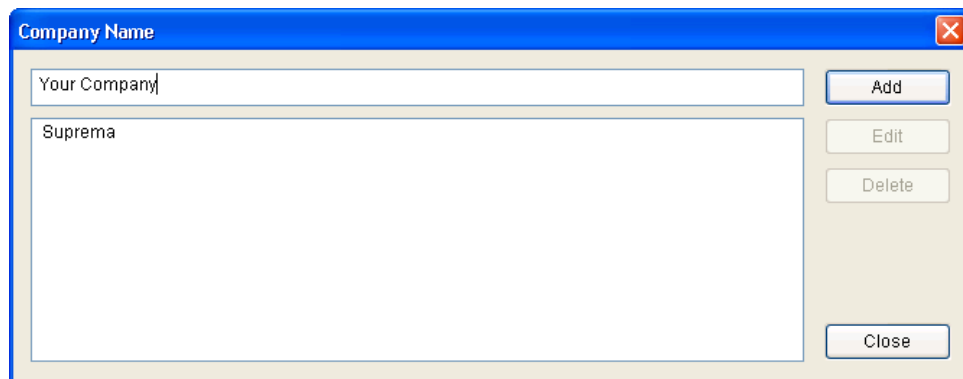

- In addition to the basic user information, you can add **Custom Fields** to the user information. If you do not need these **custom fields**, just skip the custom fields setting. To set up the custom fields, press Custom Fields tab.

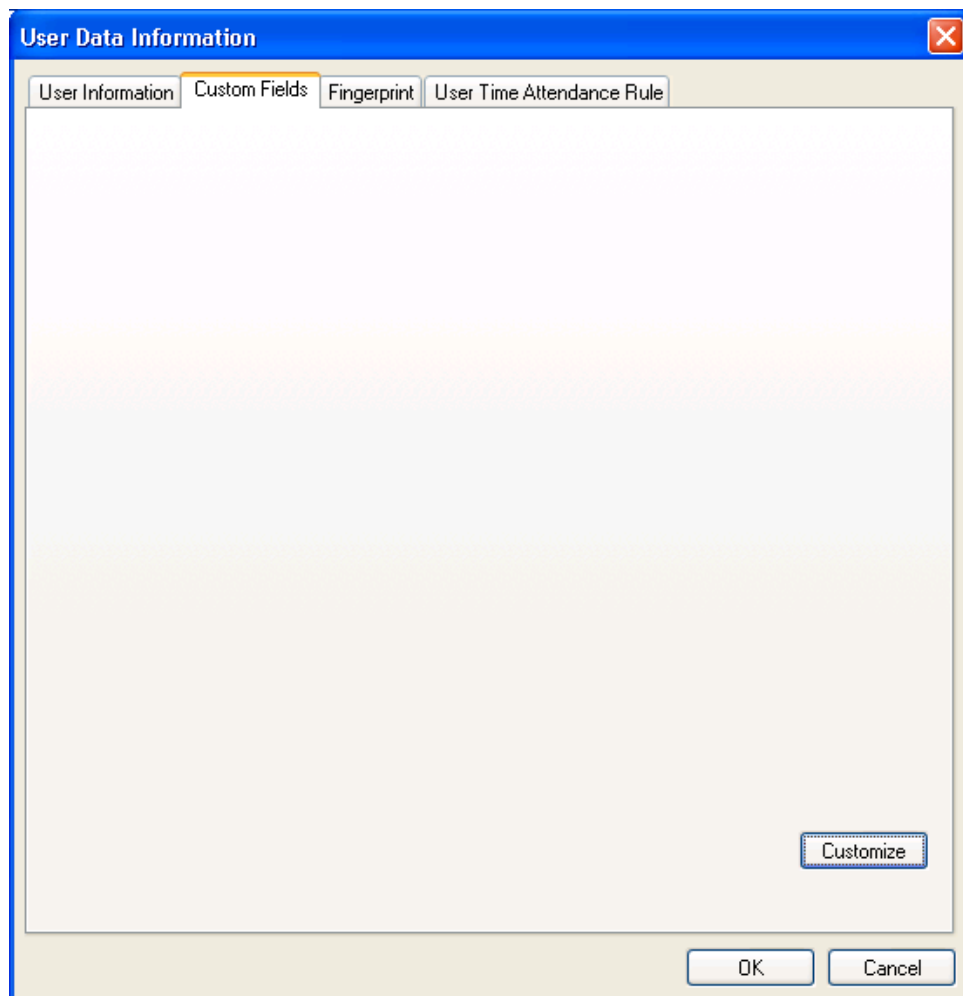

- Click the **Customize...** button.
- Check on the required Fields and enter the user information for those selected fields.

**Custom Fields**

**Text Fields**

<input checked="" type="checkbox"/> Text 1	Hobby	<input type="checkbox"/> Text 5	
<input checked="" type="checkbox"/> Text 2	Fax.	<input type="checkbox"/> Text 6	
<input checked="" type="checkbox"/> Text 3	Ip Addr	<input type="checkbox"/> Text 7	
<input type="checkbox"/> Text 4		<input type="checkbox"/> Text 8	

**Number Fields**

<input checked="" type="checkbox"/> Number 1	Room No.	<input type="checkbox"/> Number 3	
<input type="checkbox"/> Number 2		<input type="checkbox"/> Number 4	

**Date Fields**

<input checked="" type="checkbox"/> Date 1	A Memorial Day	<input type="checkbox"/> Date 3	
<input type="checkbox"/> Date 2		<input type="checkbox"/> Date 4	

**Checkboxes**

<input checked="" type="checkbox"/> Checkbox 1	Married	<input type="checkbox"/> Checkbox 3	
<input checked="" type="checkbox"/> Checkbox 2	Car	<input type="checkbox"/> Checkbox 4	

OK Cancel

- After entering the user information, press the **OK** button.
- After filling out the custom fields, the following pop-up window will appear. On this window, you can see the details of your selected custom fields. Press **OK** button to save these custom fields.
- After entering the user information, press the **Fingerprint** tab to enroll user's fingerprint templates.



The screenshot shows the 'User Data Information' dialog box with the 'Fingerprint' tab selected. The dialog has four tabs: 'User Information', 'Custom Fields', 'Fingerprint', and 'User Time Attendance Rule'. The 'Fingerprint' tab contains the following elements:

- Use Device as Enroll Station
- Device ID: [42965] New BioEntry (dropdown) and Wiegand /Card ID Setup (button)
- 1:1 Security Level: BioStation/BioEntry Plus (dropdown) and Device Default (dropdown)
- BioEntry Smart/Pass: Device Default (dropdown)
- Smart Card / RF ID section:
  - Smart Card S/N: S/N:0 (text field)
  - RF: 000-0 (text field)
  - User ID: UserID:853 (text field)
  - Bypass Card
  - Buttons: Read Card, Write Card, Format Card, Verification Test
- 1st Template and 2nd Template sections:
  - Each has a  Duress checkbox and a large empty rectangular area for the fingerprint template.
  - Buttons: Scan and Delete for each template.
- Bottom buttons: OK and Cancel.

- Acquire first template by pressing the **Scan** button followed by touching finger on the USB fingerprint scanner twice.

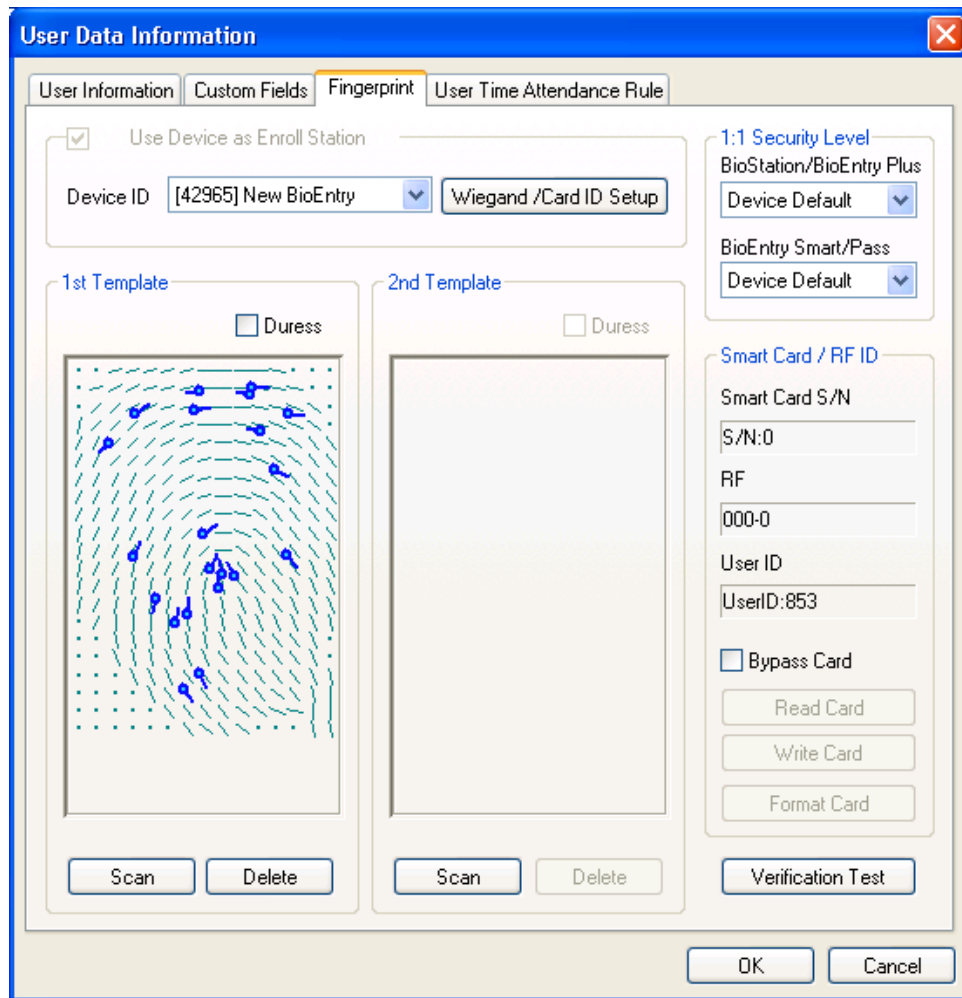

- Acquire second template similarly to the acquisition of first template.

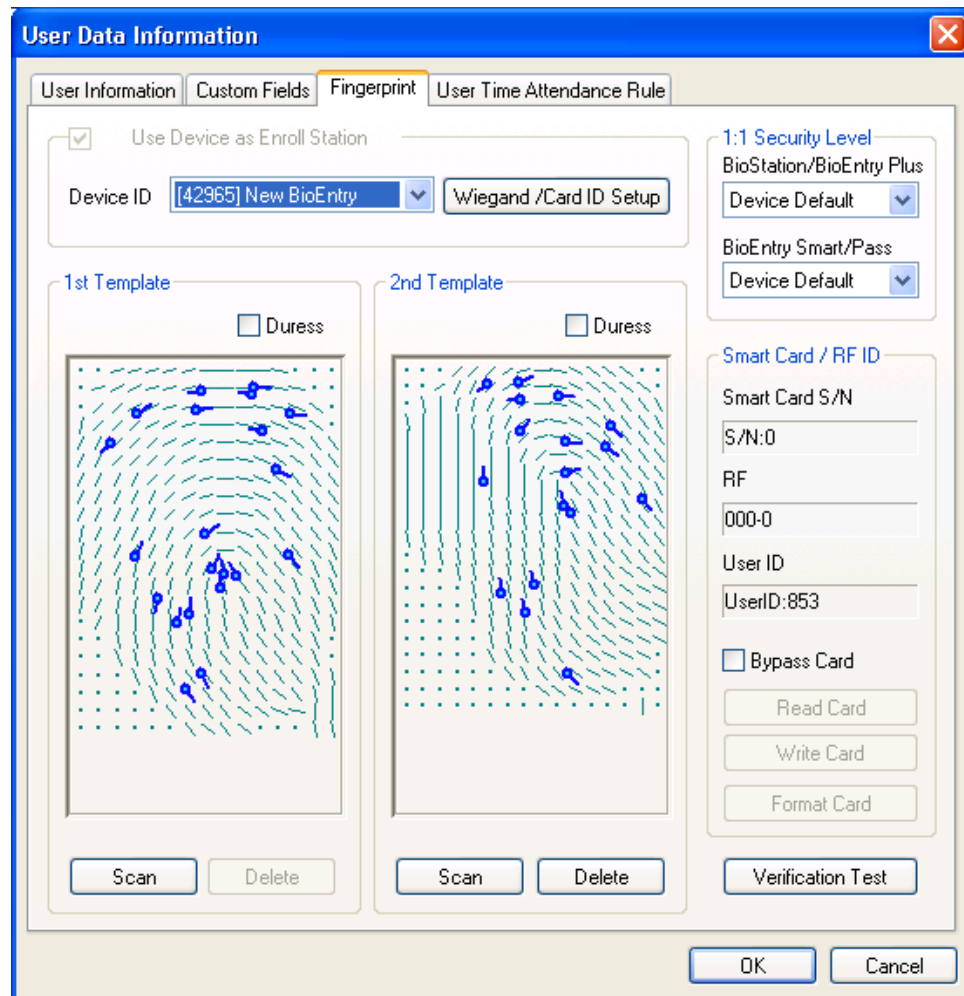

- Press the **OK** button to complete the registration process. Then, you can see the information of the registered user on the user list window. It means that user's information is added to the database on host PC.

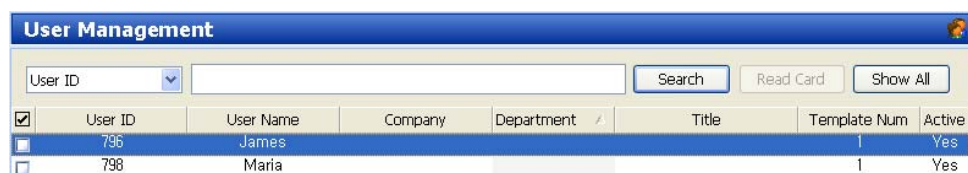

### 3.4.3. Step 3: Issuing user smart card

- Double click the registered user on the user list. Then, the user information window appears showing the registered information of the user.
- Click **Fingerprint** tab on user information window.

- Place a smart card on PC USB smart card device and press **Write** button.

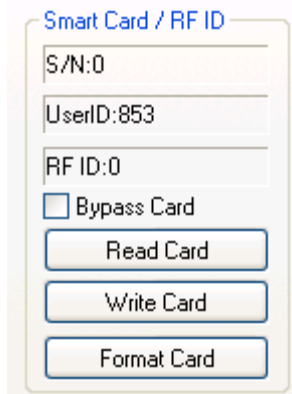

Smart Card / RF ID

S/N:0

UserID:853

RF ID:0

Bypass Card

Read Card

Write Card

Format Card

- At first trial, site key management window appears. If the key input remains blank, factory default key is used. So, just press **OK** button to complete issuing process if the site key was not changed from factory setting.

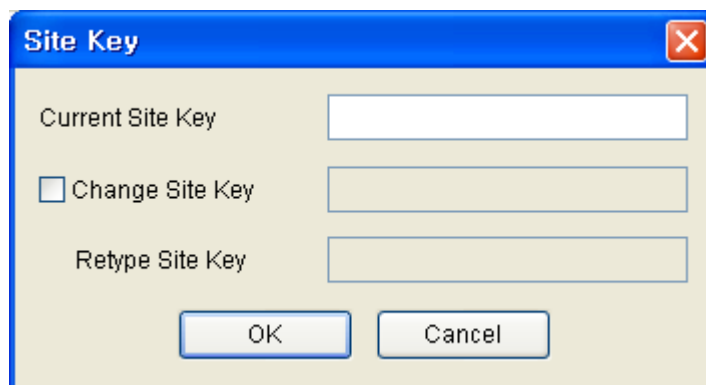

Site Key

Current Site Key

Change Site Key

Retype Site Key

OK Cancel

- On the user list window, you can see the serial number of the smart card.

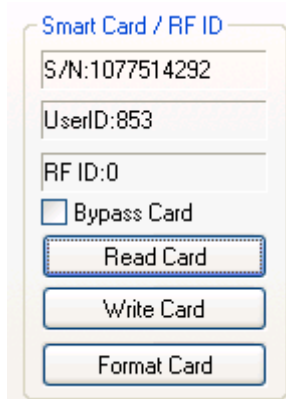

Smart Card / RF ID

S/N:1077514292

UserID:853

RF ID:0

Bypass Card

Read Card

Write Card

Format Card

- Select the **Smart Card** menu. Then you can see smart card is added on the list.

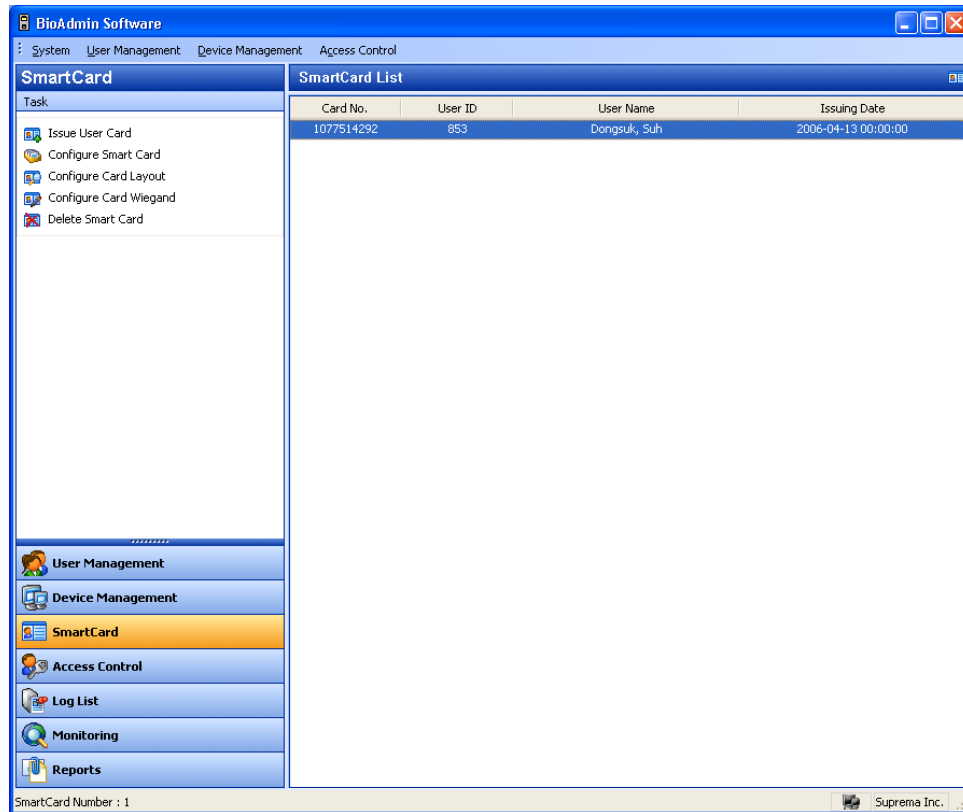

#### 3.4.4. Step 4: Enroll user ID in the external controller

It is required that the issued user ID is also registered to the controller to grant access when the Wiegand string for the user is received.

If you are using Suprema's BEACon controller, you can just skip this additional registration to the controller.

#### 3.4.5. Step 5: Authentication Test

Procedure to test verification using the user's smart card is as follows :

- First, place the user's smart card in front of the device below the sensor. Then, amber LED blinks rapidly indicating that the device is waiting for finger scan for verification.
- Place a finger on the sensor. If the user is successfully verified steady green LED appears with one beep sound. Otherwise, red LED appears with 3 beep

sounds.

- On successful verification, the Wiegand string is also sent to the controller, which can be checked by operation of relay on the controller.

### 3.5. Quick start with BioEntry Pass

This section describes the basic procedures to operate BioEntry Pass without a PC device.

#### 3.5.1. Step 1: Hardware installation

In this configuration, the device is connected to an external controller via Wiegand interface as well as to the host PC through RS485 interface. It is assumed that the controller supports the standard 26 bit Wiegand format as default of BioEntry device.

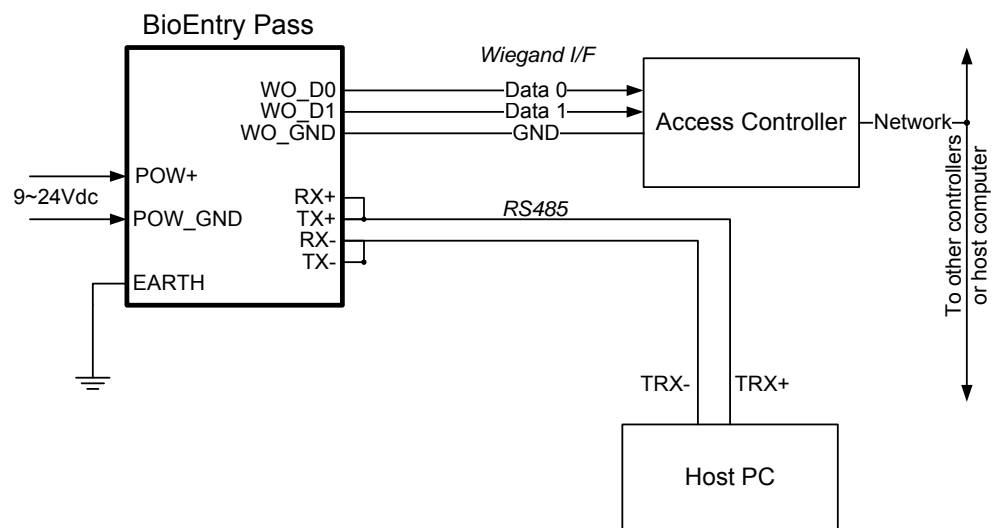

For more details on the installation, refer to the BioEntry Installation manual or BEACon Operation Manual.

#### 3.5.2. Step 2: Search new device

- Run BioAdmin software.
- Enter Login ID and password. By factory default, the initial Login ID is “**admin**” and the password is blank
- Select **Device Management** on the Main menu, then device management page will appear on the main window.

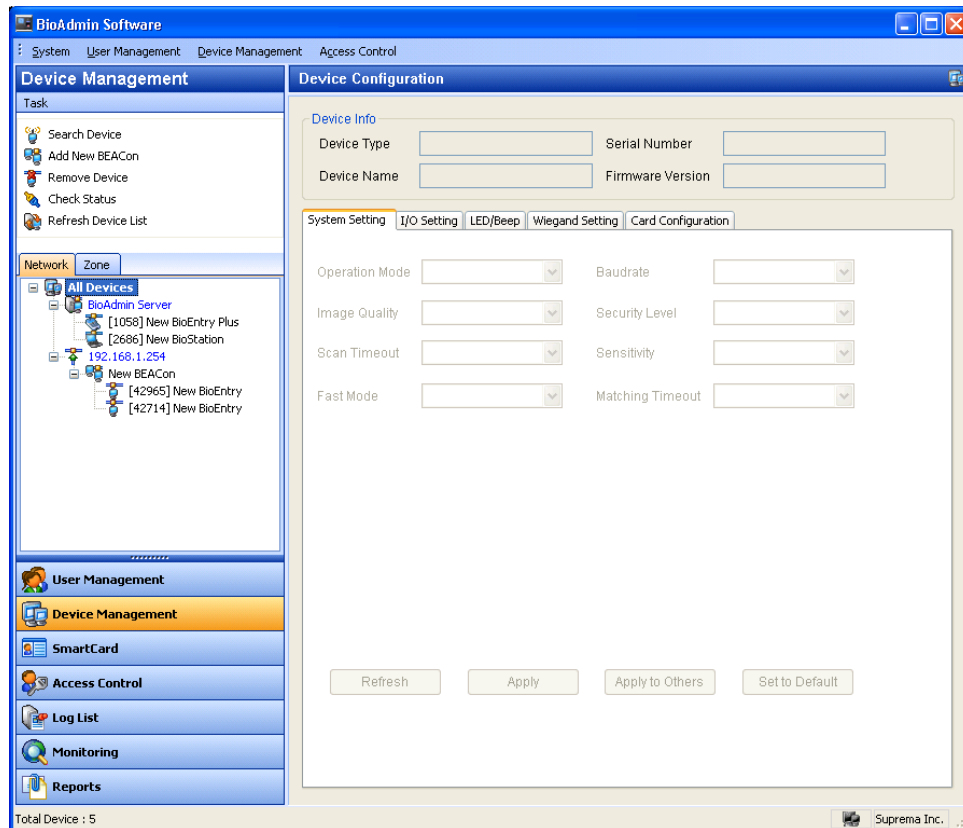

- Select **Search Device** menu, click **Search BioEntry**, select either serial port or TCP/PI and then press search button. If device is found as a result of search, result report reading '--- device(s) found' is shown. Press **OK** button to select device.

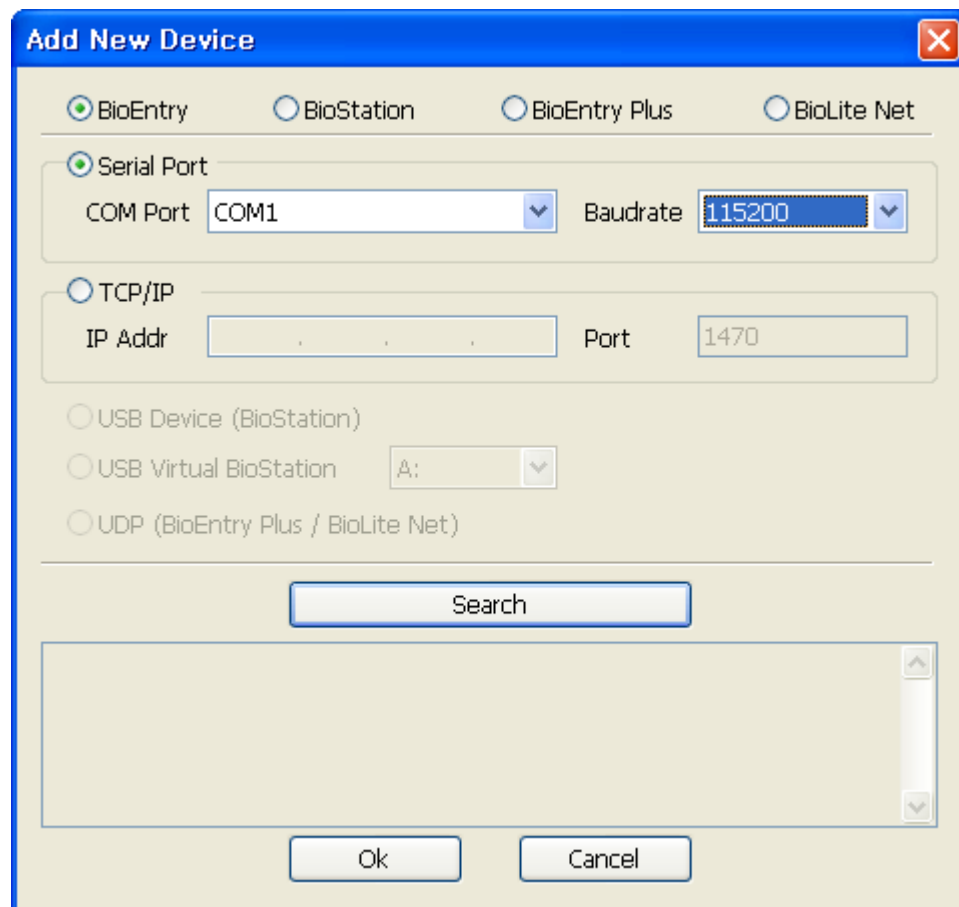

- If the devices are connected properly, new device ID appears on the Device Tree window.



- Select **User Management** button on main menu and select **Manage users in device** on task window.
- Once device is selected, fingerprint information such as user ID, number of fingerprint, access group, security level and Check (to select) is displayed.



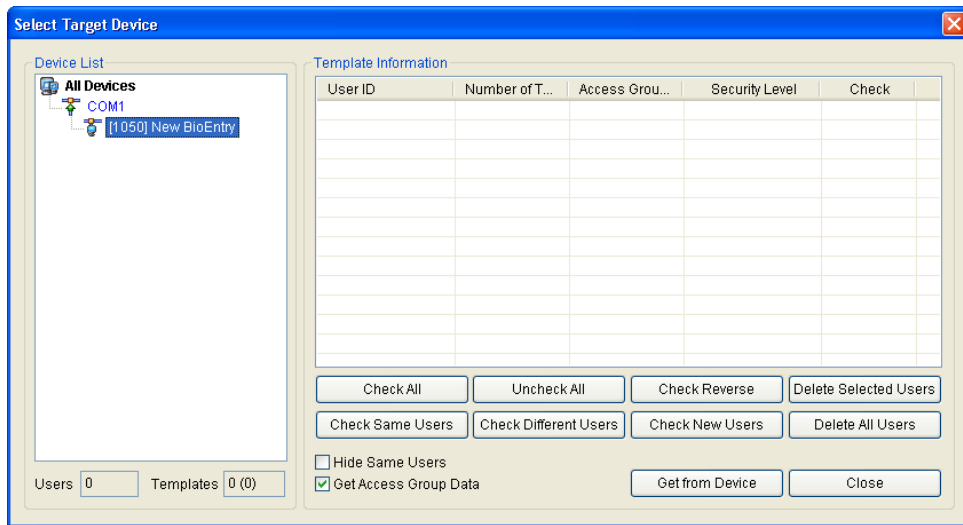

3.5.3. Step 3: Enroll user

- Select the **User Management** menu, then the user management page appears on the main window

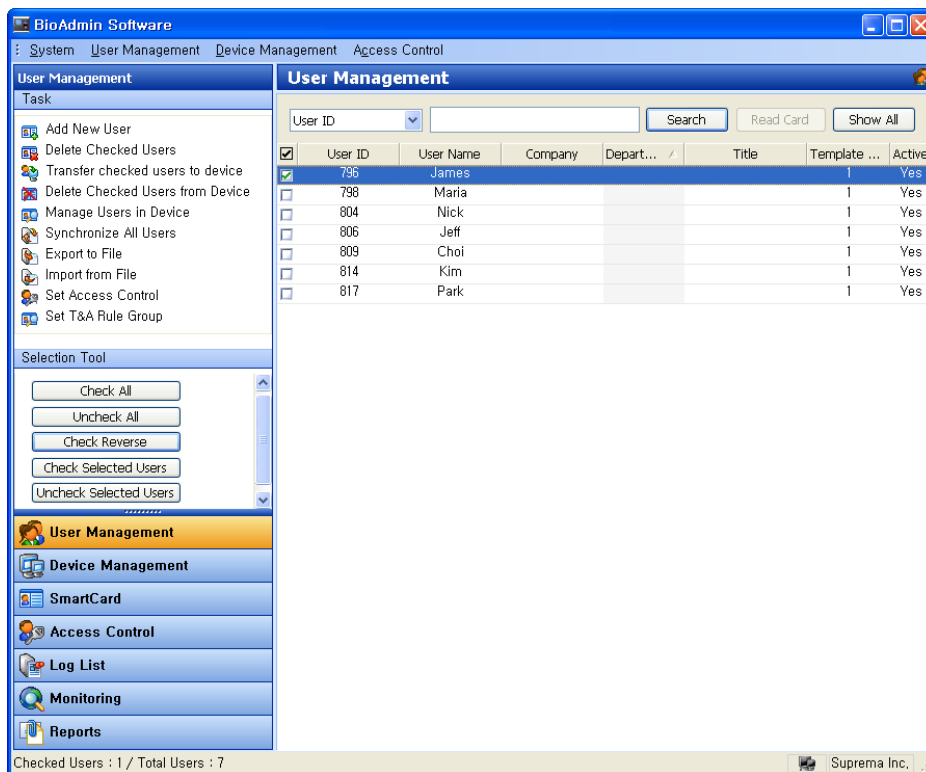

- Select the **Add New User** menu on the task window, and then the pop-up

window appears.

**User Data Information**

User Information | Custom Fields | Fingerprint | User Time Attendance Rule

**Basic Personal Information**

User ID: [i] [ ] [ Edit Private Information ]

Name: [ ]

Company: [ None ] [ v ] [ ... ]

Department: [ None ] [ v ] [ ... ]

Title: [ None ] [ v ] [ ... ]

**Details**

Phone: [ ]

Mobile: [ ]

E-Mail: [ ]

Gender: [ Male ] [ v ]

Date of Birth: [ 10/16/2007 ] [ v ]

Start Date: [ 1/ 1/1970 ] [ v ]

Expiry Date: [ 12/31/2030 ] [ v ] [ 0 ] h

**Access Group**

Status:  Active

Group 1: [ Full Access ] [ v ]

Group 2: [ None ] [ v ]

Group 3: [ None ] [ v ]

Group 4: [ None ] [ v ]

**Entrance Limitation (BioStation)**

Daily Limit: [ 0 ] (0:00~23:59)

Timed APB: [ 0 ] Minute

**Other Information**

Password: [ ]

BST Admin Level: [ Normal User ] [ v ]

[ OK ] [ Cancel ]

- Enter the user information on the **User Information** tab.

**User Data Information**

User Information | Custom Fields | Fingerprint | User Time Attendance Rule

**Basic Personal Information**

User ID: 853

Name: Dongsuk, Suh

Company: Suprema

Department: R&D

Title: Manager

**Details**

Phone: 012-345-6789

Mobile: 098-765-4321

E-Mail: dsuck@anymail

Gender: Male

Date of Birth: 6/14/1970

Start Date: 1/ 1/1970

Expiry Date: 12/31/2030  0 h

**Access Group**

Status:  Active

Group 1: Full Access

Group 2: None

Group 3: None

Group 4: None

**Entrance Limitation (BioStation)**

Daily Limit: 0 (0:00~23:59)

Timed APB: 0 Minute

**Other Information**

Password:

BST Admin Level: Normal User

- Especially, you can select the Company, Department, and Title on the drag down menu.
- To add new Company, Department, or Title information, press the  button. After entering the required information, press the **Add** button. Press the **Save** button to save the added information.

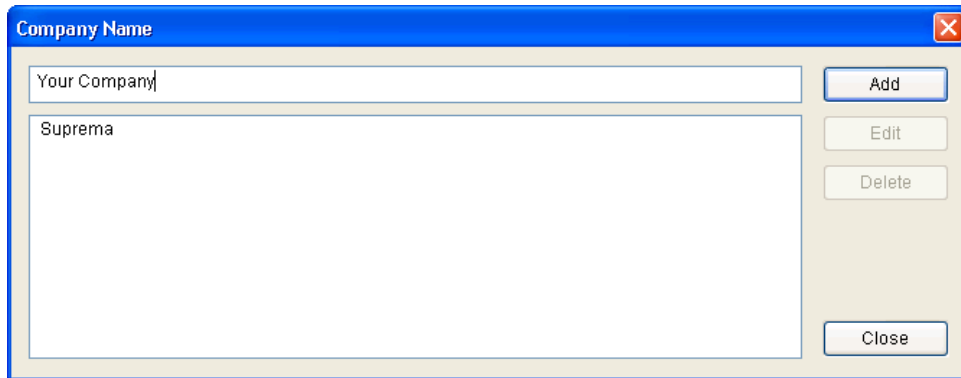

- In addition to the basic user information, you can add the **Custom Fields** to the user information. If you do not need these custom fields, just skip the custom fields setting. To set up the custom fields, press the **Custom Fields** tab.

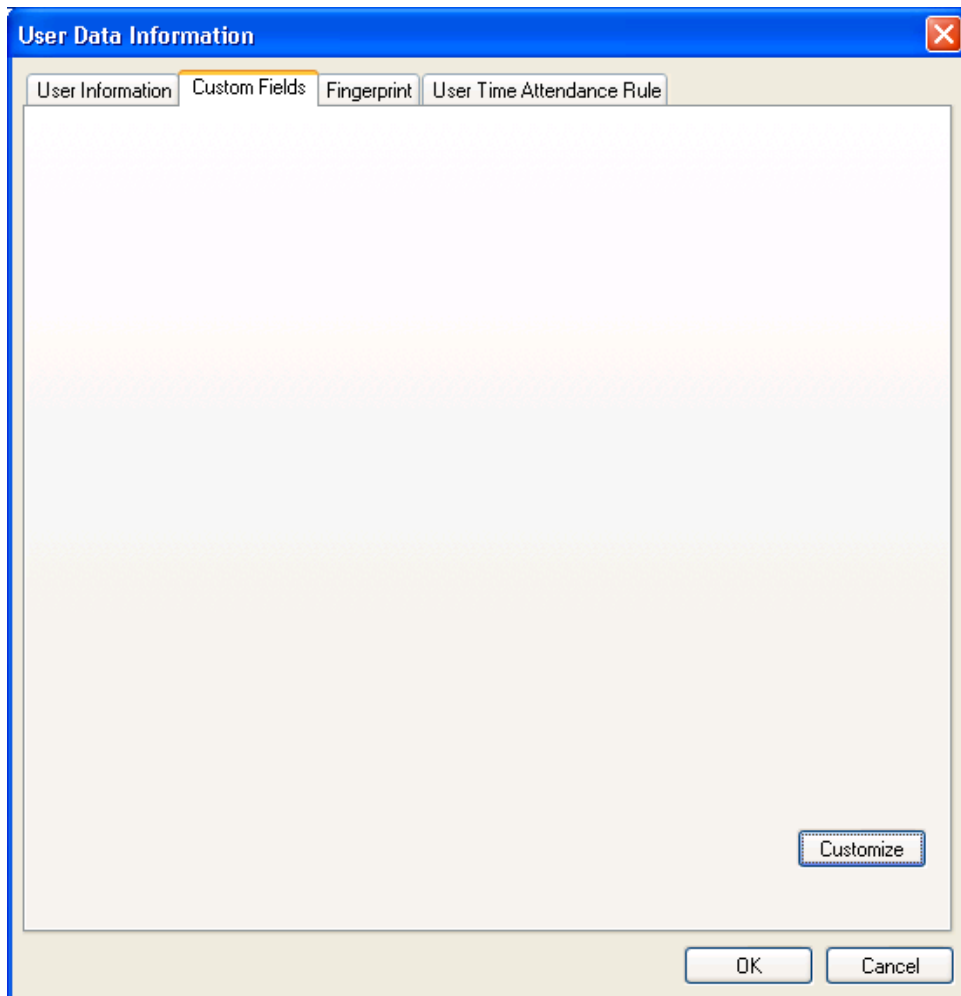

- Click the **Customize...** button.
- Check on the required fields and enter the user information for those selected fields.
- After entering the user information, press the **OK** button.

**Custom Fields**

**Text Fields**

<input checked="" type="checkbox"/> Text 1	Hobby	<input type="checkbox"/> Text 5	
<input checked="" type="checkbox"/> Text 2	Fax	<input type="checkbox"/> Text 6	
<input checked="" type="checkbox"/> Text 3	Ip Addr	<input type="checkbox"/> Text 7	
<input type="checkbox"/> Text 4		<input type="checkbox"/> Text 8	

**Number Fields**

<input checked="" type="checkbox"/> Number 1	Room No.	<input type="checkbox"/> Number 3	
<input type="checkbox"/> Number 2		<input type="checkbox"/> Number 4	

**Date Fields**

<input checked="" type="checkbox"/> Date 1	A Memorial Day	<input type="checkbox"/> Date 3	
<input type="checkbox"/> Date 2		<input type="checkbox"/> Date 4	

**Checkboxes**

<input checked="" type="checkbox"/> Checkbox 1	Married	<input type="checkbox"/> Checkbox 3	
<input checked="" type="checkbox"/> Checkbox 2	Car	<input type="checkbox"/> Checkbox 4	

OK Cancel

- After filling out the custom fields, following the pop-up window will appear. On this window, you can see the detail of your selected custom fields. Press the **OK** button to save these custom fields.

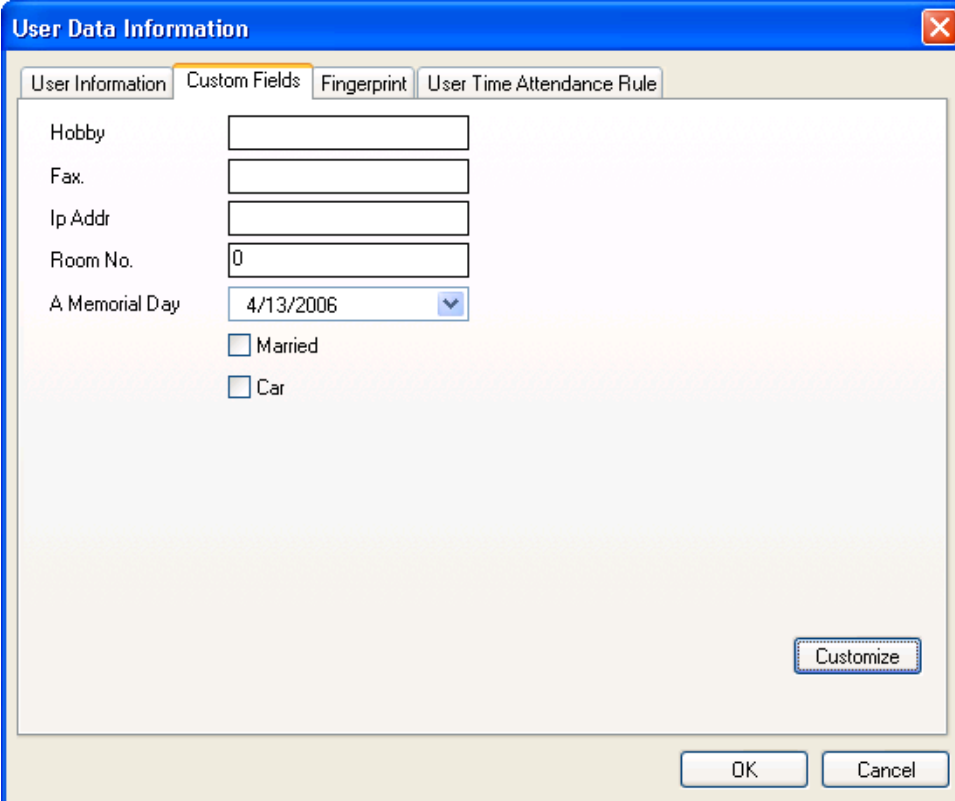

The image shows a Windows-style dialog box titled "User Data Information". It has a blue title bar with a close button (X) in the top right corner. Below the title bar are four tabs: "User Information", "Custom Fields", "Fingerprint", and "User Time Attendance Rule". The "Custom Fields" tab is currently selected and highlighted in yellow. The main area of the dialog contains several input fields and checkboxes:

- Hobby: [Text input field]
- Fax: [Text input field]
- Ip Addr: [Text input field]
- Room No.: [Text input field containing "0"]
- A Memorial Day: [Date dropdown menu showing "4/13/2006"]
- Married
- Car

At the bottom right of the main area is a "Customize" button. At the bottom of the dialog are "OK" and "Cancel" buttons.

- After entering the user information, press the **Fingerprint** tab to enroll user's fingerprint templates.

The screenshot shows the 'User Data Information' dialog box with the 'Fingerprint' tab selected. The dialog has a blue title bar and a close button in the top right corner. It contains several sections:

- User Information:** A checked checkbox for 'Use Device as Enroll Station'. Below it, a 'Device ID' dropdown menu is set to '[2686] New BioStation', and a 'Wiegand /Card ID Setup' button is present.
- 1:1 Security Level:** A section with two dropdown menus. The first is 'BioStation/BioEntry Plus' set to 'Device Default'. The second is 'BioEntry Smart/Pass' also set to 'Device Default'.
- Smart Card / RF ID:** A section with input fields for 'Smart Card S/N' (S/N:0), 'RF' (000-0), and 'User ID' (UserID:853). Below these are a 'Bypass Card' checkbox and three buttons: 'Read Card', 'Write Card', and 'Format Card'. A 'Verification Test' button is located at the bottom of this section.
- 1st Template:** A large empty rectangular area for the first fingerprint template. It has a 'Duess' checkbox at the top right. Below the area are 'Scan' and 'Delete' buttons.
- 2nd Template:** A second large empty rectangular area for the second fingerprint template, identical in layout to the first.

At the bottom of the dialog are 'OK' and 'Cancel' buttons.

- Acquire first template by pressing the **Scan** button followed by touching a finger on the USB fingerprint scanner twice.

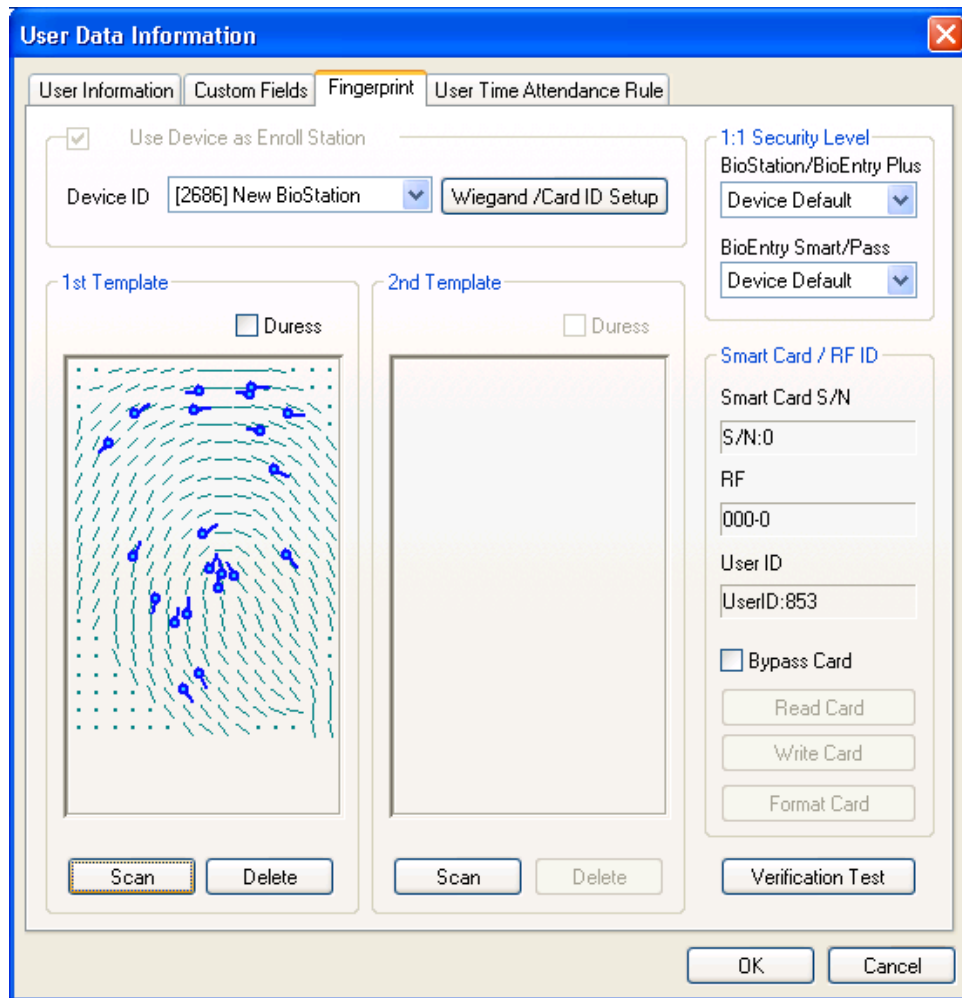

- Acquire second template similarly to the acquisition of first template.



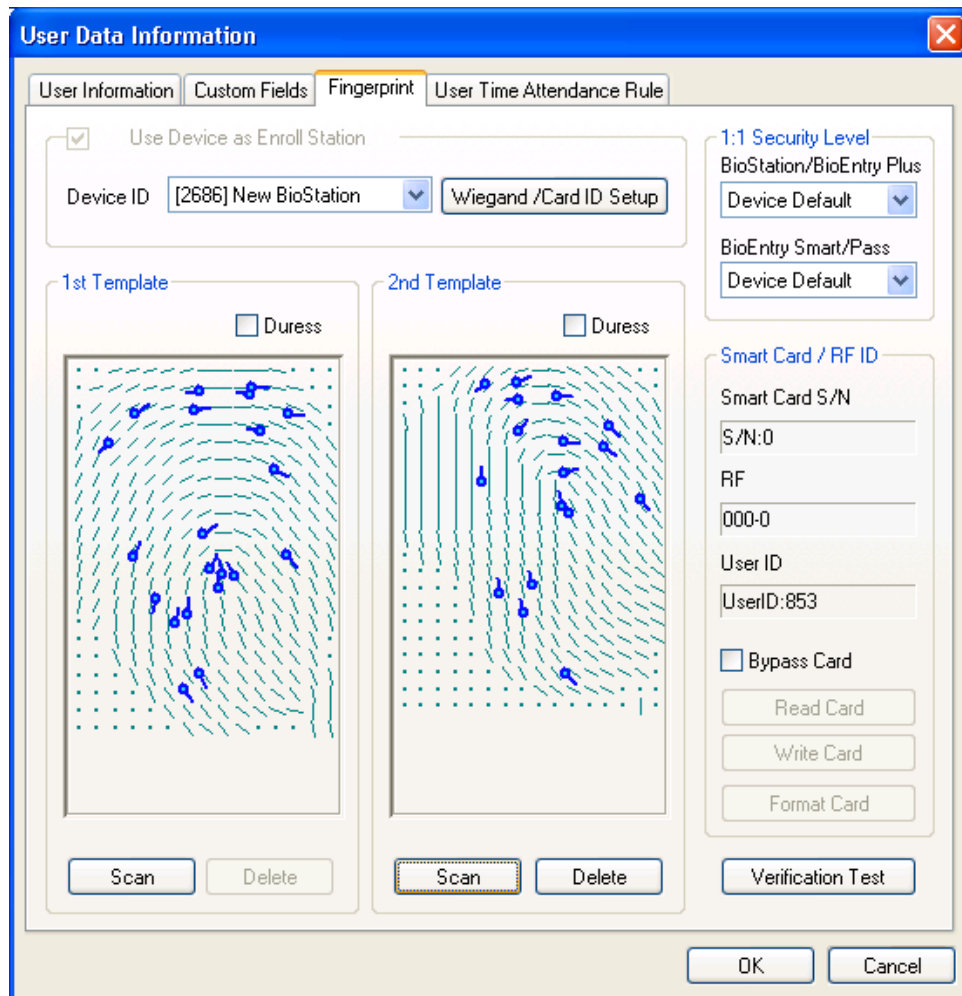

- Press the **OK** button to complete the registration process. Then, you can see the information on the registered user on the user list window. It means that the user's information is added to the database on host PC.



#### 3.5.4. Step 4: Enroll user with 'transfer checked user to device' menu.

Transfer to Device is used to transfer the user database of the host PC to BioEntry™ devices. The user information such as User ID, templates, access group, and security level is transferred by this process.

- Check the registered user to transfer

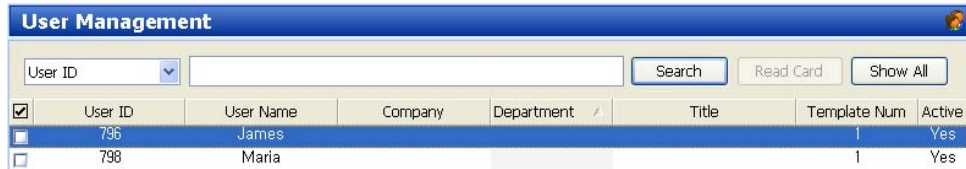

- Select the Transfer Checked Users to Device button and select the devices to transfer the user data.

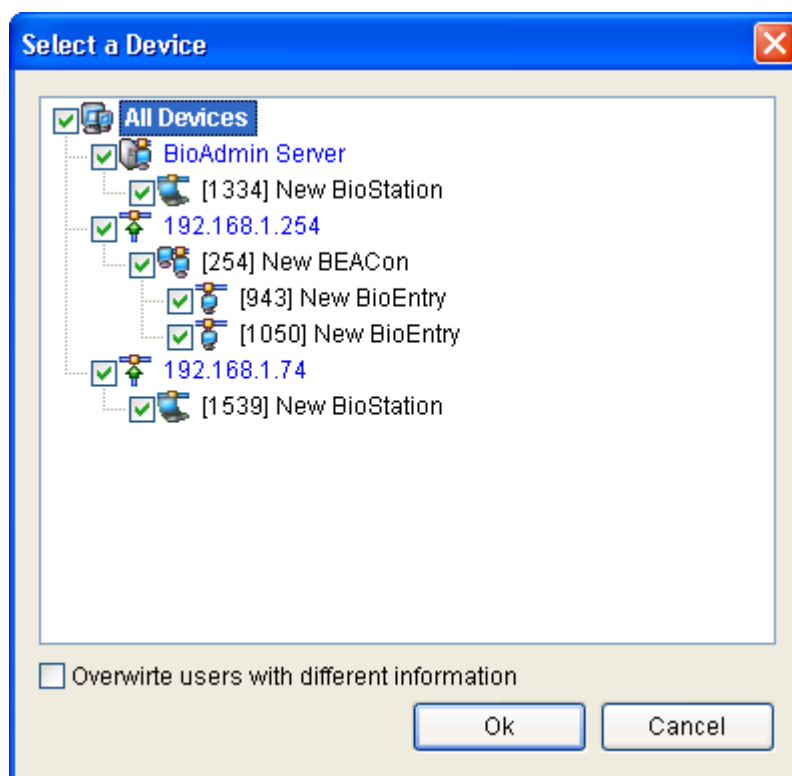

- Select the **Manage Users in Device** button to see the user list enrolled in the selected device. If the color of user data is yellow, it means the user data has been successfully transferred to the device.

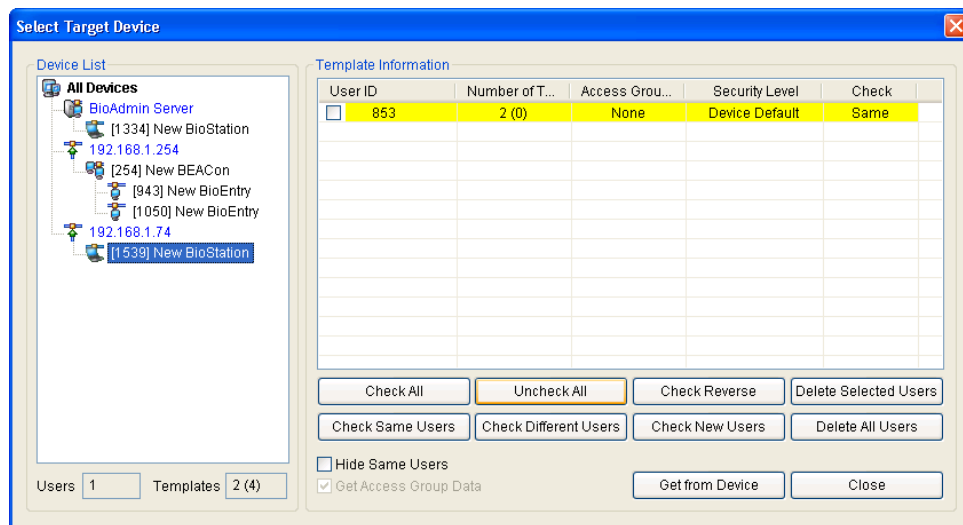

### 3.5.5. Step 5: Enroll user ID in the external controller

It is required that the issued user ID is also registered to the external controller to grant access when the Wiegand string for the user is received.

If you are using Suprema's BEACon controller, you can just skip this additional registration to the controller.

### 3.5.6. Step 6: Authentication test

- Amber LED on the device blinks slowly indicating that the device is waiting for finger scan for identification.
- Swipe finger on the sensor. If the user is successfully identified steady green LED appears with one beep sound. Otherwise, red LED appears with 3 beep sounds.
- On successful identification, the Wiegand string is also sent to the controller, which can be checked by operation of relay on the controller.

### 3.5.7. Step 7: Monitoring

Select **Start Monitoring** menu to start the real-time monitoring on all of the connected BioEntry devices.

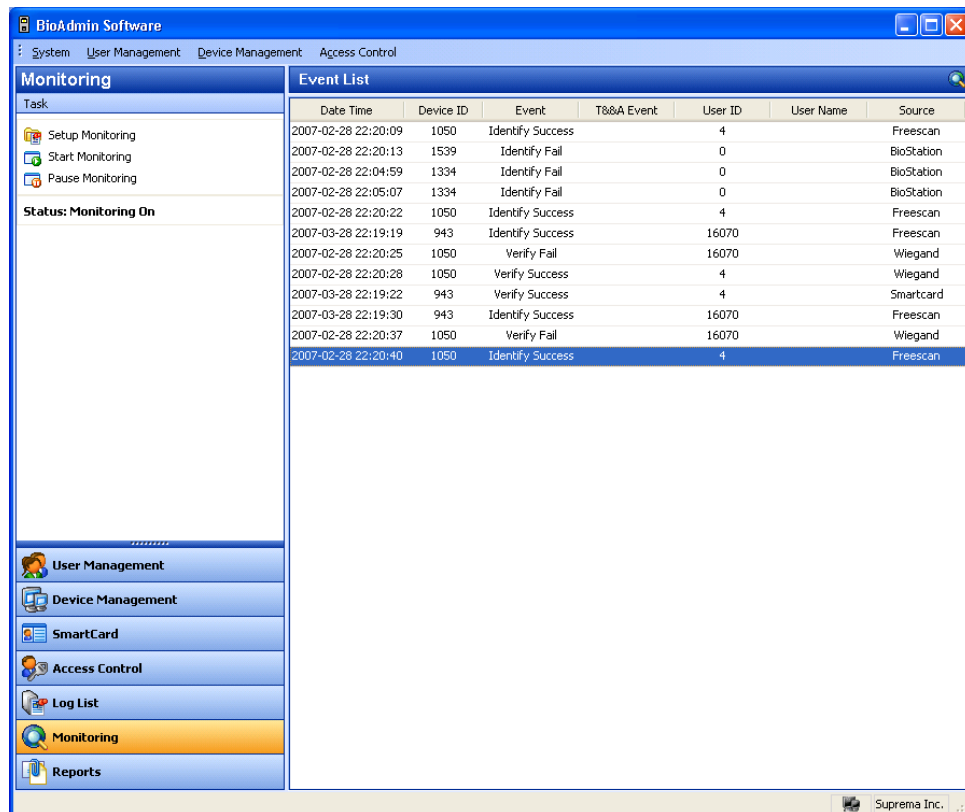

3.5.8. Step 8 : Check log

- Select the **Reports** menu. Then, the report list window appears on the main window.
- Select the **Get Recent Logs / Auto Upload** button to see the updated event log data added to the existing log list of BioAdmin.

Date Time	Device ID	Event	T&A Event	User ID	User Name	Source
2007-02-28 11:31:05	1334	Enroll Success		2		BioStation
2007-02-28 11:31:06	1334	Enroll Success		3		BioStation
2007-02-28 11:31:07	1334	Enroll Success		853	Dongsuk, Suh	BioStation
2007-02-28 11:31:08	1334	Enroll Success		861	Nakwon, Lee	BioStation
2007-02-28 11:31:09	1334	Enroll Success		934	ChangGyun, Lee	BioStation
2007-02-28 11:36:26	1334	Identify Mode...		1		BioStation
2007-02-28 12:00:51	1334	Delete Success		1		BioStation
2007-02-28 12:00:51	1334	Delete Success		2		BioStation

## 4. User Management

User management covers the following operations:

- Add new user
- Delete checked user
- Transfer checked user to device
- Delete checked user from device
- Manage users in device
- Synchronize all users
- Export to file
- Upload from file

### 4.1. Configuration of user management page

By selecting User Management menu, user management page is updated on the main window.

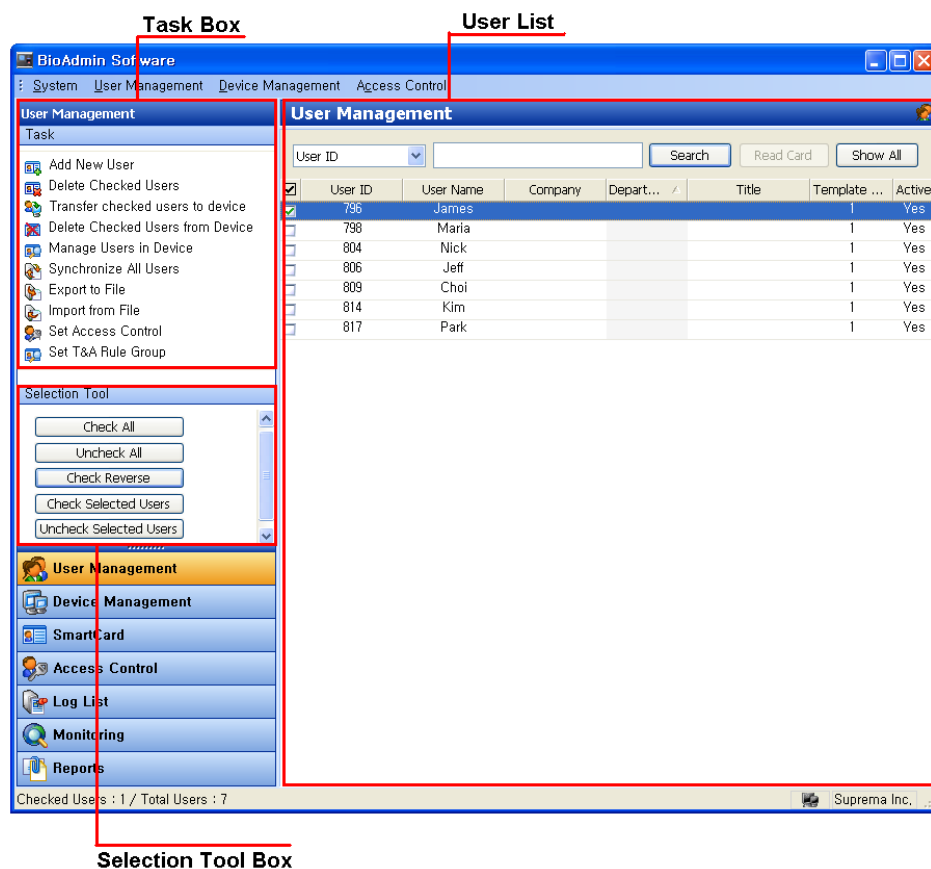

The user management page is divided into 3 sectors:

- User List

The user database is under central management on host PC. The user management page includes detailed list of user database and summarized information.

- Selection tool box

Selection tool box includes buttons to select users.

- Task box

Task box includes buttons to control basic operations of the user management page.

## 4.2. User List window

User list includes the following information on the users.

- Shows basic information such as user ID, name, company, dept., position title, number of enrolled fingerprint and status.
- Double click user ID to pop up user information window. User information has 4 tabs, i.e. User information, custom field, fingerprint, and user time attendance rule.
- Fingerprint templates ( fingerprint image is never stored )

Note : What is activation in access group setting? It is used when transferring user data in host PC to device. If activation is not on (checked) upon transferring checked in user list to device, user data can't be transferred and data in device is deleted.

For instance, when one returns to work after having been excluded from access group and inactive due to dispatch or long term leave, activate him/her and manage user list.

## 4.3. User List Display Setting

You can customize the display of the user list.

Detailed operations are as follows.

- Press the right button of your mouse on the column header of User List.

Note : What is "Column Header"? It is on the head of row (user ID, name,

company, dept.) on user list window.

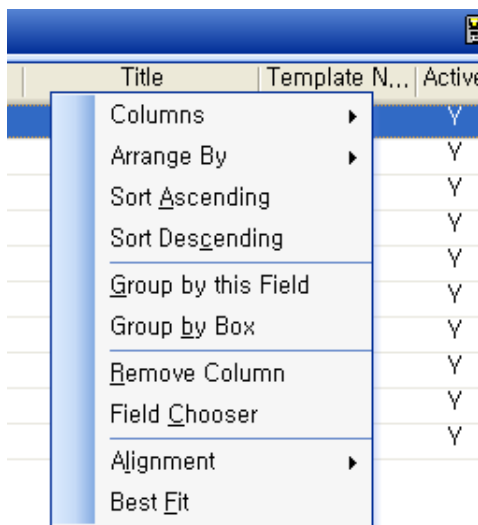

- Press the **Columns** button and check on your required columns to show them on the user list.

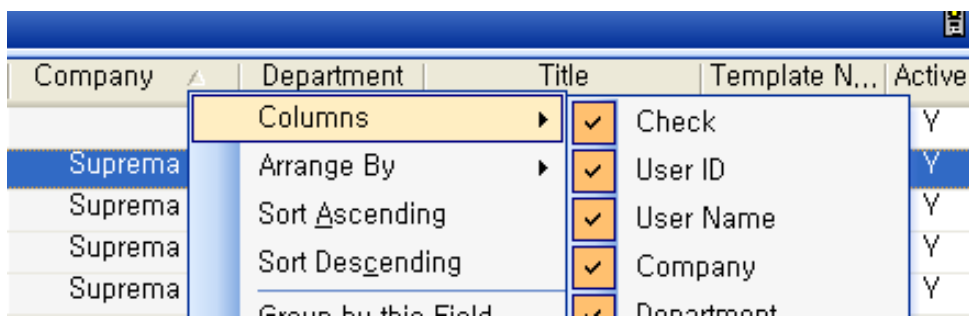

- Press the **Arrange By** button and select your required columns to array the user list by your selected column.

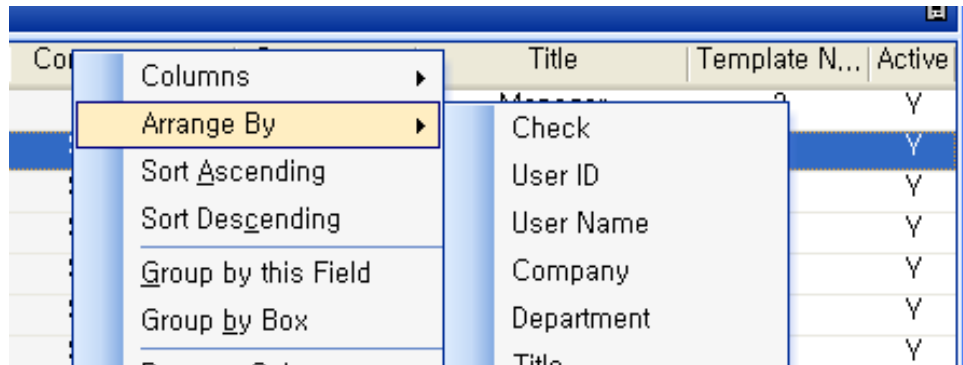

- Press the **Sort Ascending** button to array the user list in ascending order.
- Press the **Sort Descending** button to array the user list in descending order.
- Press the **Group by this field** button and **Group by box** button to manage the user list as a group by your required columns. Also, you can add a column to the group simply by dragging up the column to the header box.

Department							
<input checked="" type="checkbox"/>	User ID	User Name	Company	Departm...	Title	Template N...	Active
[-] Department: M&S							
<input type="checkbox"/>	934	ChangGyun, Lee	Suprema	M&S	Manager	2	Y
<input type="checkbox"/>	1205	Gunsaeng, Shin	Suprema	M&S	Manager	2	Y
<input type="checkbox"/>	3786	Hyunbok, Jeon	Suprema	M&S	Chief	2	Y
<input type="checkbox"/>	4465	Bohyun, Gha	Suprema	M&S		2	Y
<input type="checkbox"/>	4583	Gyunhun, Hong	Suprema	M&S		2	Y
[-] Department: R&D							
<input checked="" type="checkbox"/>	853	Dongsuk, Suh	Suprema	R&D	Manager	2	Y
<input type="checkbox"/>	861	Nakwon, Lee	Suprema	R&D		2	Y
<input type="checkbox"/>	1144	Hoyoung, Gyou...	Suprema	R&D	Engineer	2	Y
<input type="checkbox"/>	4582	Ilhwan, Gang	Suprema	R&D	Engineer	2	Y
<input type="checkbox"/>	4584	Jonguk, Hwang	Suprema	R&D	Manager	2	Y

- Press the **Remove Column** button to remove a column from the header. Also, you can remove a column simply by dragging down the column from the column header.

Department							
<input checked="" type="checkbox"/>	User ID	User Name	Company	Departm...	Title	Template N...	Active
[-] Department: M&S							
<input type="checkbox"/>	934	ChangGyun, Lee	Suprema	M&S	Manager	2	Y
<input type="checkbox"/>	1205	Gunsaeng, Shin	Suprema	M&S	Manager	2	Y



- Press the **Alignment** button to array the content in your preferred way.
- Press the **Best Fit** button to optimize the width of a column.

#### 4.4. Search User

For the enrolled many users, you can easily search user via User ID, User Name, or Card Number.

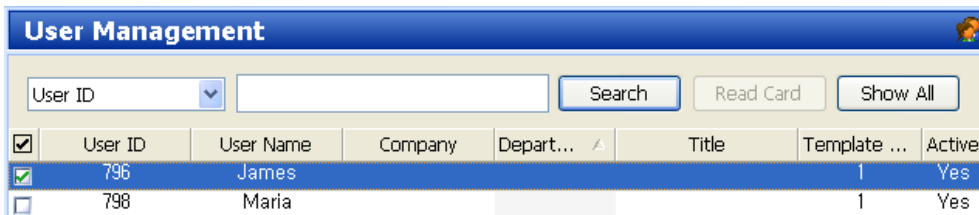

In case of Card Number search, select 'Card Number', click 'Read Card', and type enrolled card number. or type enrolled card number in above figure.

(Read Card No. 그림 추가)

#### 4.5. Select user

Users can be chosen for selective processing of operations, such as transfer, removal, or exportation. You can select the required user simply by using the check box on the user list,

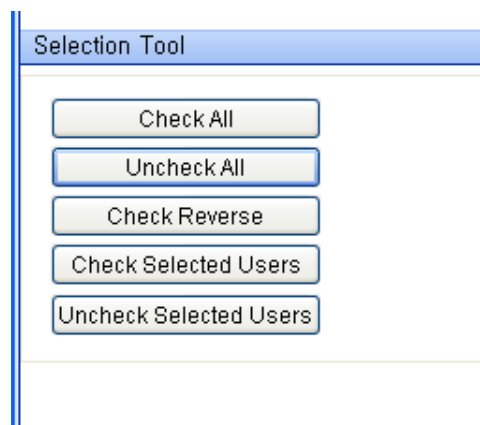

- Check All : Check all users
- Uncheck All : Uncheck all users

- Check Reverse : Check all users except the users who were originally checked
- Check Selected Users : Check the selected users
- Uncheck Selected Users : Uncheck the selected users

#### 4.6. Add New User

The **Add New User** button enables the pop-up window to register user data on host PC.

**User Data Information**

User Information | Custom Fields | Fingerprint | User Time Attendance Rule

**Basic Personal Information**

User ID: 853 [Edit Private Information]

Name: Dongsuk, Suh

Company: Suprema [v] [...]

Department: R&D [v] [...]

Title: Manager [v] [...]

**Details**

Phone: 012-345-6789

Mobile: 098-765-4321

E-Mail: dsuck@anymail

Gender: Male [v]

Date of Birth: 6/14/1970 [v]

Start Date: 1/ 1/1970 [v]

Expiry Date: 12/31/2030 [v] 0 h

**Access Group**

Status:  Active

Group 1: Full Access [v]

Group 2: None [v]

Group 3: None [v]

Group 4: None [v]

**Entrance Limitation (BioStation)**

Daily Limit: 0 (0:00~23:59)

Timed APB: 0 Minute

**Other Information**

Password: [ ]

BST Admin Level: Normal User [v]

OK Cancel

##### 4.6.1. User information

- In user information, you can enter basic personal information, details information, access group, other information, and additional information for BioStation. In basic personal information, enter user ID, name, company, dept. and title. For details, enter telephone number, mobile phone number, email,

gender, and date of birth. Make sure to check 'Active' in access group. Otherwise, database in device will be deleted.

- Edit Private Information



- Change photo and message when succeeded in verification, and configure display condition, which should be used 'Private Information' of the device.

- Access Group

- Enter the access group information for each user.
- To apply the designated access group information to each user, please check on the **Active** option and sent transmit this user to the BioStation and BioEntry. If you do not check on this option or do not transmit the user to the BioStation or BioEntry, access group will not be applied to each user.
- If you check on **Bypass ID** option, that user will be able to access the door just by placing this card to the BioStation without fingerprint or password.
- **Auth Limit** means the number of access that the user is allowed in a day (from 00:00 to 24:00 of the day). If you do not want to restrict the number of access for a user, leave this menu as the default, 0.
- **Timed** means the minimum time interval required for access of the same user. If you set this menu as 5, that user will not be able to enter the door again within 5 minutes.

- 
- Other Information
  - The Password on this menu is required when the BioStation requires the user's password. Also, users should enter this password when they log in to the BioAdmin Client to check their log information.
  - BioStation admin level : On this menu, you can select the user as an administrator for BioStation terminal.

Note : in user information, user ID should be entered as it's a required field but the rest fields can be left blank.

#### 4.6.2. Custom field

You can add customized user information columns on the user management window by designating required fields on the Custom Fields menu.

- Customize... button enables the pop-up window to add the customized user information column. After filling out the required contents, press the OK button.

The image shows a 'User Data Information' dialog box with a blue title bar and a close button in the top right corner. It features four tabs: 'User Information', 'Custom Fields', 'Fingerprint', and 'User Time Attendance Rule'. The 'Custom Fields' tab is currently selected. The form contains the following fields and options:

- Hobby: Fishing
- Fax: 031-4567-8562
- IP Addr: 123.123.12.1
- Room No.: 0
- A Memorial Day: 6/14/2007 (dropdown menu)
- Married
- Car

At the bottom right of the form area is a 'Customize' button. At the bottom of the dialog box are 'OK' and 'Cancel' buttons.

**Custom Fields**

**Text Fields**

<input checked="" type="checkbox"/> Text 1	Hobby	<input type="checkbox"/> Text 5	
<input checked="" type="checkbox"/> Text 2	Fax.	<input type="checkbox"/> Text 6	
<input checked="" type="checkbox"/> Text 3	Ip Addr	<input type="checkbox"/> Text 7	
<input type="checkbox"/> Text 4		<input type="checkbox"/> Text 8	

**Number Fields**

<input checked="" type="checkbox"/> Number 1	Room No.	<input type="checkbox"/> Number 3	
<input type="checkbox"/> Number 2		<input type="checkbox"/> Number 4	

**Date Fields**

<input checked="" type="checkbox"/> Date 1	A Memorial Day	<input type="checkbox"/> Date 3	
<input type="checkbox"/> Date 2		<input type="checkbox"/> Date 4	

**Checkboxes**

<input checked="" type="checkbox"/> Checkbox 1	Married	<input type="checkbox"/> Checkbox 3	
<input checked="" type="checkbox"/> Checkbox 2	Car	<input type="checkbox"/> Checkbox 4	

OK Cancel

Note : Custom fields may look like a blank page but if you click settings on the right lower end, a display where you are to set custom fields such as string, number, date and checkbox appears. If you check such fields, items are generated in blank custom fields.

#### 4.6.3. Fingerprint

The next step of registration is adding user's fingerprint templates to database.

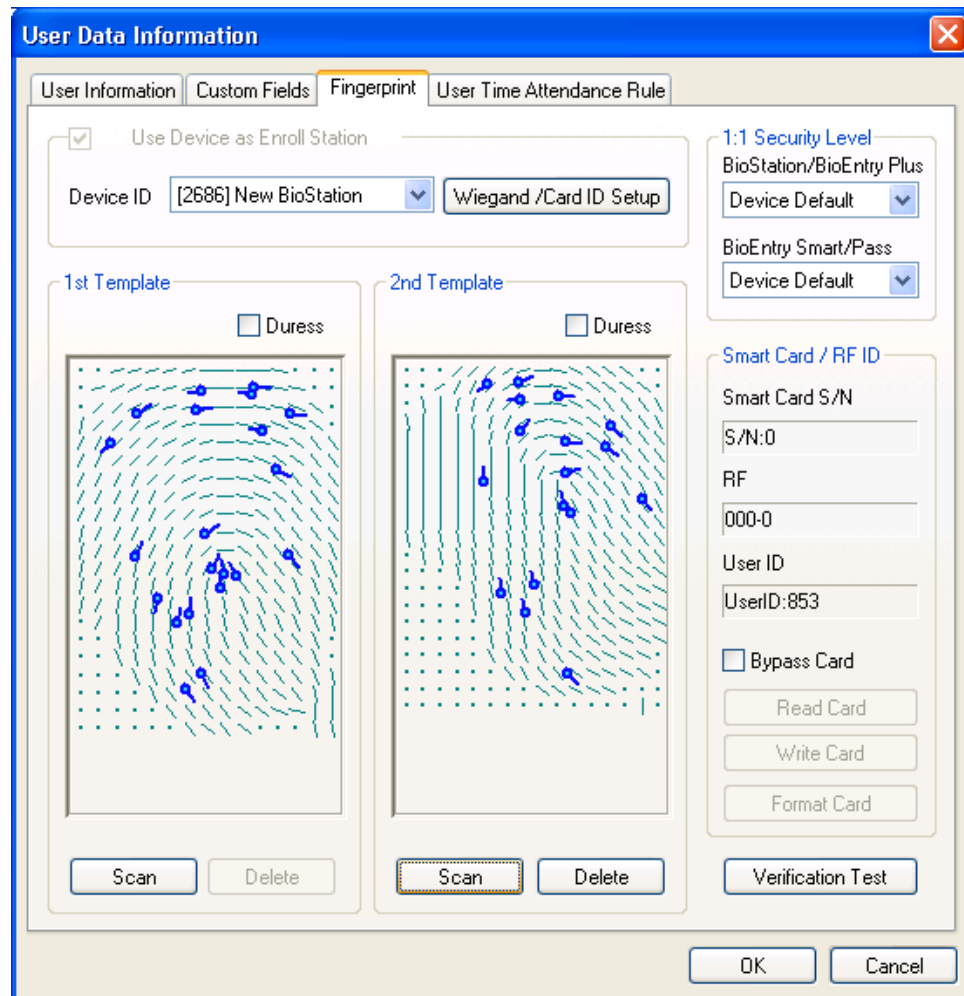

Templates can be enrolled by two methods:

- Enrollment using PC USB scanner
- Enrollment using BioEntry device connected to host PC

By default, USB scanner is used for enrollment. By enabling the **Use BioEntry as Enroll Station** check box and selecting a device ID, BioEntry™ device is used to get user's templates. Up to 2 fingerprint templates can be included in the user database.

- Acquisition of template

Press the **Scan** button and touch the same finger twice. If the acquisition of template is successful, scanned template is depicted on the template window. To register the second template for different finger, press the **Scan** button at the right section.

- Enrollment of duress finger

Duress finger can be enrolled to generate duress signal when the specified finger is detected on the device. After a template is acquired, enable the **Duress** check box to indicate that the template should be saved as duress mode.

Note : What is duress mode?

Duress finger can be used in a situation when one is threatened by a thief in front of a door. If duress finger is entered, door is opened normally but it can be set to sound an emergency alarm or ring an emergency call which has been set as output port. For instance, in case of enrolling 2 fingers, the first finger can be enrolled as normal finger whereas the second finger as duress finger. Duress finger should be a different finger from a normal finger enrolled beforehand.

- Delete fingerprint

To delete fingerprint, delete from the second fingerprint information on the right. The first fingerprint information can be deleted after the second fingerprint information is deleted.

- Test matching

In order to check that enrollment of template is properly completed, matching test can be processed. Press the **Test Matching** button and touch the registered finger on the specified device. Then, a message will appear to show the matching result.

- Wiegand / RF ID Set up

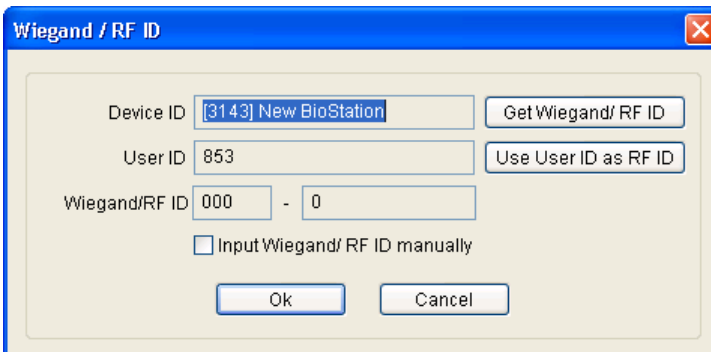

The screenshot shows a dialog box titled "Wiegand / RF ID" with a close button (X) in the top right corner. The dialog contains the following fields and controls:

- Device ID: [3143] New BioStation
- User ID: 853
- Wiegand/RF ID: 000 - 0
- Buttons: "Get Wiegand/ RF ID" (next to Device ID), "Use User ID as RF ID" (next to User ID), "Ok", and "Cancel".
- Checkbox:  Input Wiegand/ RF ID manually

If you use BioStation RF or use the normal BioStation along with an external Wiegand card reader, you need to allocate the card ID to each user. Press this



button to designate the users' card ID.

- **Get Wiegand / RF ID** : If you press **Get Wiegand / RF ID** button, BioStation RF (or external Wiegand card reader) will be waiting for the card. If the user put his card to the BioStation (or to the external Wiegand card reader), the Wiegand ID of that card will be registered as the user's card ID. Therefore, you can use this option to get the Wiegand ID from the card and apply it to the user.
  - **Use User ID as RF ID** : If you press **Use User ID as RF ID** button, Wiegand card ID is entered as same as the user ID. This menu is useful when the users were already using Wiegand cards of which card ID was set as same as the user ID.
  - **Input Wiegand / RF ID manually** : If you press **Input Wiegand / RF ID manually** button, you can enter the Wiegand / RF ID manually.
- 1:1 Security Level.

You can change the security level for the 1:1 verification of BioEntry and BioStation. If a user's fingerprint condition is very poor and he often fails in 1:1 verification, administrator may enroll his fingerprint after lowering the 1:1 security level for that user.

#### 4.6.4. Issue user smart card

BioEntry Smart basically operates with user's smart card containing user information and fingerprint templates. Issuing is required to create the user's smart card.

Issuing of user's smart card is processed on the user management window, which is initiated by double clicking a user on the user list or by pressing the **Register New User** button on the main window.

Smart card can be issues by two methods:

- Issuing with PC USB smart card device
- Issuing with BioEntry™ Smart connected with host PC

To use a BioEntry™ Smart as a card issuer, enable the **Use BioEntry as Enroll Station** check box and select a device ID. Otherwise, PC USB device is used as a card issuer.

#### 4.6.5. Issue with PC USB smart card device

- Place the target smart card on the PC smart card device
- Press the **Write** button to initiate issuing.
- The site key management window will appear at the first trial of issuing after starting of BioAdmin software. Also, the window will appear if it fails to access the smart card due to the mismatch of the site key.
- Type the current site key to access the smart card. If it remains blank, BioAdmin software uses default key ( 0xFFFFFFFF ) as a current site key.
- If it is desired to change the site key on issuing, enable the **Change Site Key** check box and type new site key. Then, new site key is updated on the smart card. The new site key should be correspondent with the site key on BioEntry Smart device.

#### 4.6.6. Issue with BioEntry Smart

- Place the target smart card at selected BioEntry Smart
- Press the **Write** button to initiate issuing. Since the site key management information is stored on BioEntry, issuing is processed without requesting site key.

#### 4.6.7. User security level and all-time pass card (Bypass) setting

On issuing, security level can be specified for each user. By changing Security Level dropdown list, user's security level can be specified from 1/1,000 to 1/100,000,000. If **Device Default** is selected, security level configured on BioEntry Smart device is used.

To issue all-time pass card (bypass card), you can choose bypass card option.

Note : What is bypass card? Device authorizes a user with a card without fingerprint authentication process.
--

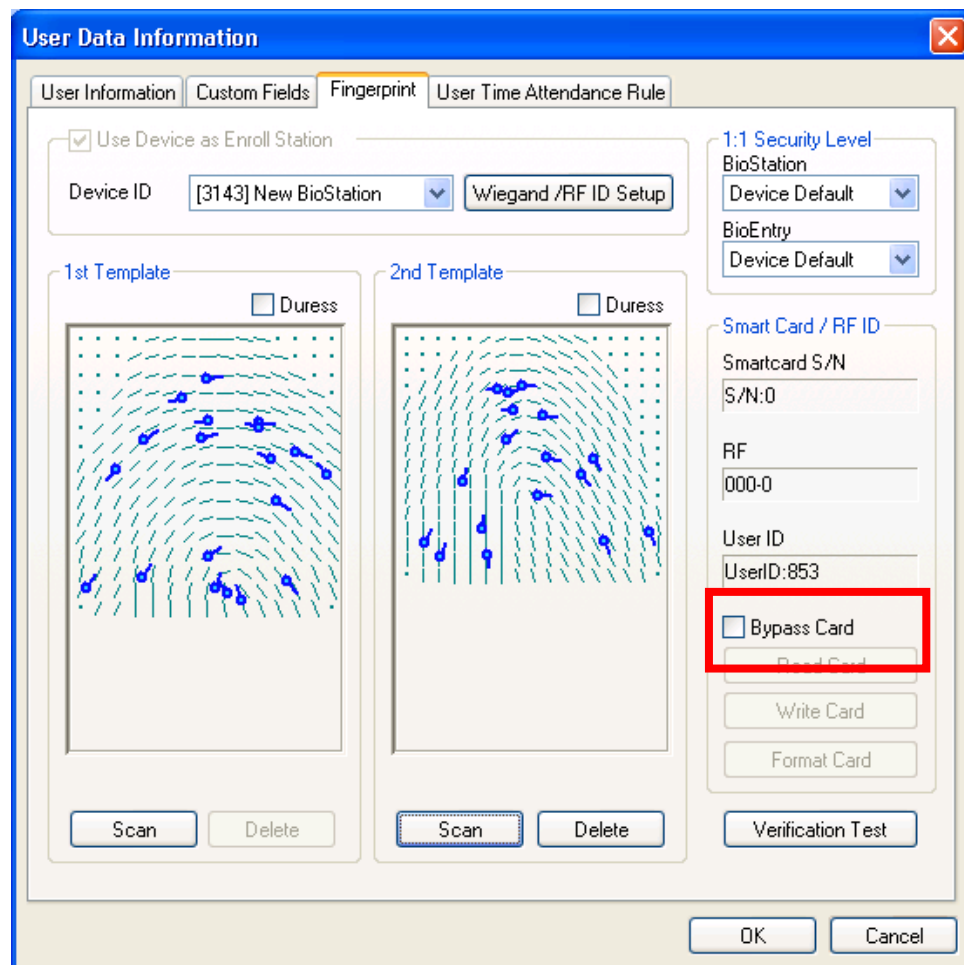

#### 4.6.8. Wiegand string setting using ID card

On issuing a smart card, the specific Wiegand string contained in customer's ID card can be transferred to the smart card. For this operation, RF Wiegand device should be connected to the Wiegand input port of the selected BioEntry device.

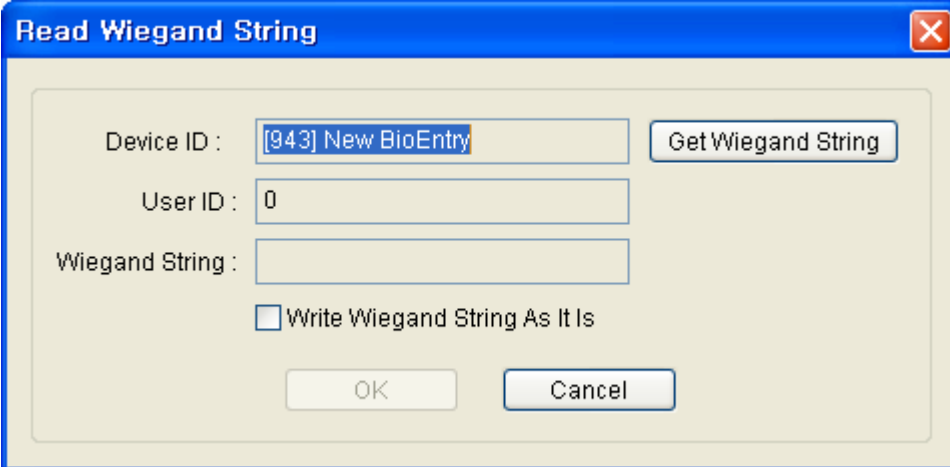

Detailed operations are as follows.

- Press the **Wiegand String Setup** button
- Press the **Get Wiegand String** button and touch the ID card containing Wiegand string on the Wiegand device.
- The Wiegand string received from the device is displayed on the user management window.
- Enable **Write Wiegand String As It Is** is check box to use the Wiegand string instead of the user ID
- Press **OK** button to issue the user's smart card. Then, the received Wiegand string is stored on the smart card. If the check box is disabled, the Wiegand string converted from user ID is written to the smart card.

#### 4.6.9. Read issued smart card

The information stored on the issued smart card can be retrieved by **Read Card** button on the user data information window. When PC USB smart card device is used, the site key management window will also appear if the site key is mismatched. In reading process, the site key change option is neglected.

#### 4.6.10. Card format

Formatting is the process of erasing issued information on the smart card. The **Format Card** button on the user data information window initiates formatting process. The site key change option is effective in this process.

#### 4.6.11. Notes on card issue

- Before writing on a new smartcard, you should format the new smart card first.
- Site key is not stored in BioAdmin software to improve the security of the system.

Note : It is the necessary for the administrator to remember and keep in secret the custom site key for proper management of the system. Also, please pay keen attention to changing the site key on the smart card.

- If writing to smart card is stopped accidentally in issuing process, the smart card might be corrupted and irrecoverable. Be careful to avoid accidental stop in writing smart card.

#### 4.6.12. Rules on user T&A event control

This menu is used to set user time attendance rule. For the detailed operation, refer to Chapter 12 Report.

### 4.7. Delete checked user

#### 4.7.1. Delete checked user from BioAdmin software

Delete checked user information on user list window. If you check a user and click **delete checked user** in task box, a message “do you want to delete checked (selected) user?” appears. If you press ok button, checked user is deleted from BioAdmin of the host PC.

#### 4.7.2. Synchronization deleted user information with device

If you transfer remaining user information after deleting a specific user, you can also delete such deleted user information from device.

### 4.8. Transfer checked user to device

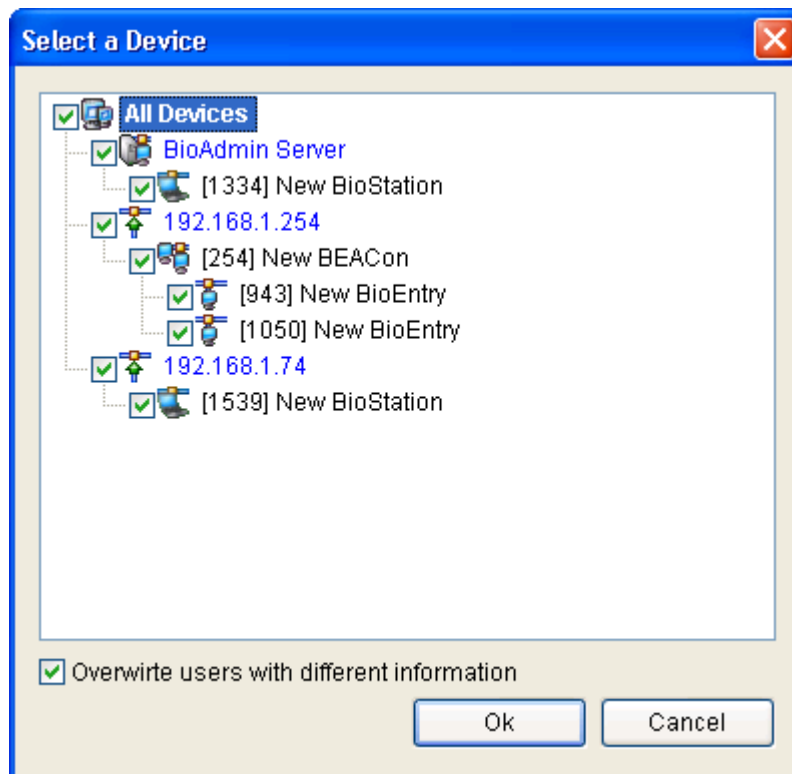

**Transfer checked users to device** is to transfer user DB in host PC to device. To run a device, user data including fingerprint information should be transferred to device after user enrollment.

User information such as user ID, finger scan information, access group and security level is transferred through this process. Transfer procedure is processed in selected device, selected group or all devices linked on network. In how to select (check) user, user information can be transferred selectively.

Detailed operating process is as follows.

- Check a user to transfer.
- Press **transfer checked users to device** button.
- Select a device on select device window.
- In case user ID is same but user information is different, if you check overwrite, data in host PC will overwrite the same user's information in device.
- If not able to find a selected user in device, new user data is transferred from host PC database to device.

#### 4.9. Delete checked users from device

On user list window, enrolled user can be deleted by **delete checked user from device** button.

Detailed operating process is as follows.

- Select a user to delete
- Press **delete checked user from device** button on task window.
- Select a corresponding device on select device display.
- Selected (checked) user is not deleted on host PC user list. To delete it from host PC user list, press 'delete checked user' button.

Note : Be careful in selecting a device in a network because it is a task to delete user information from selected device.

#### 4.10. Manage users in device

**Manage users in device** is to upload user information from device to host PC database. User information such as user ID, fingerprint information, access group number, security level is uploaded thru this process.

In this menu, you can upload user database selectively from chosen device on network.

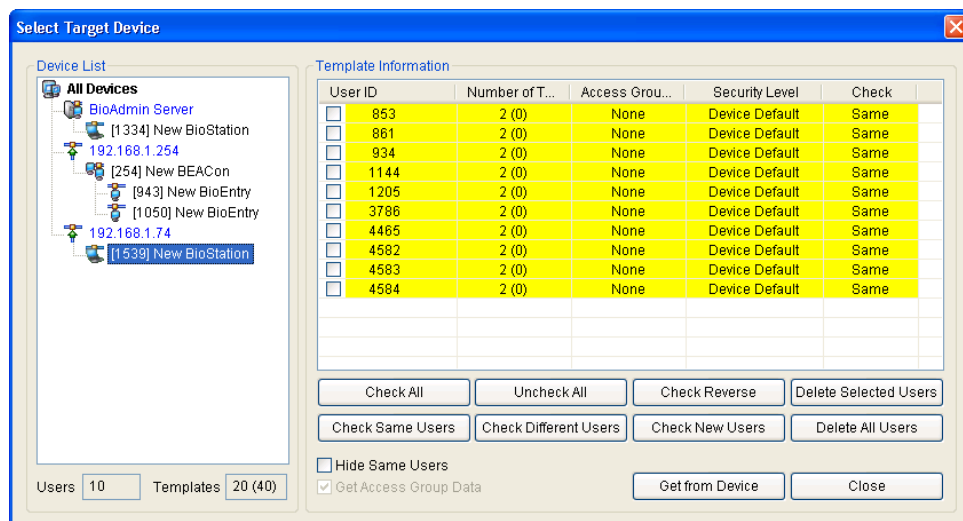

Detailed operating process is as follows.

- Press **Manage users in device** button.
- Select a corresponding device on device list window.
- Under device list window, you can see user and number of fingerprint information enrolled in the selected device.
- User classification
  - Same user : user whose user information in BioAdmin software corresponds to user information uploaded from device.
  - Different user : user whose user information in BioAdmin software doesn't correspond to user information uploaded from device.
  - New user : user information uploaded from device doesn't exist in BioAdmin software. it can be construed as surplus user in device.
- Color classification
  - Same user : indicated in yellow.
  - Different user : indicated in red.
  - New user : indicated in white.
- Check classification
  - Check all: check (select) all user information
  - Uncheck all : to uncheck after checking all user information
  - Check reverse : to uncheck checked user or check unchecked user
  - Delete selected user : to delete selected user
  - Check same users : select users whose user information in BioAdmin software corresponds to user information uploaded from device.
  - Check different users : select users whose user information in BioAdmin software doesn't correspond to user information uploaded from device.
  - Check new users : select users who are enrolled in device only but do not exist in BioAdmin software.
  - Delete all : to delete selected users and the other all users
- Hide same users

If you press check same users, checkbox of a user whose data is same both in device and host PC is checked. If you display hide same users, these users can be hidden on finger scan information window.
- Get access group data

Check a checkbox of get access group data and execute Get from device, to upload user access group information.



## 4.11. Synchronize all users

Synchronization all users button transfers all user data base in host PC to device and surplus users remaining in device only are deleted. User information such as user ID, fingerprint information, access group number and security level is uploaded thru this process.

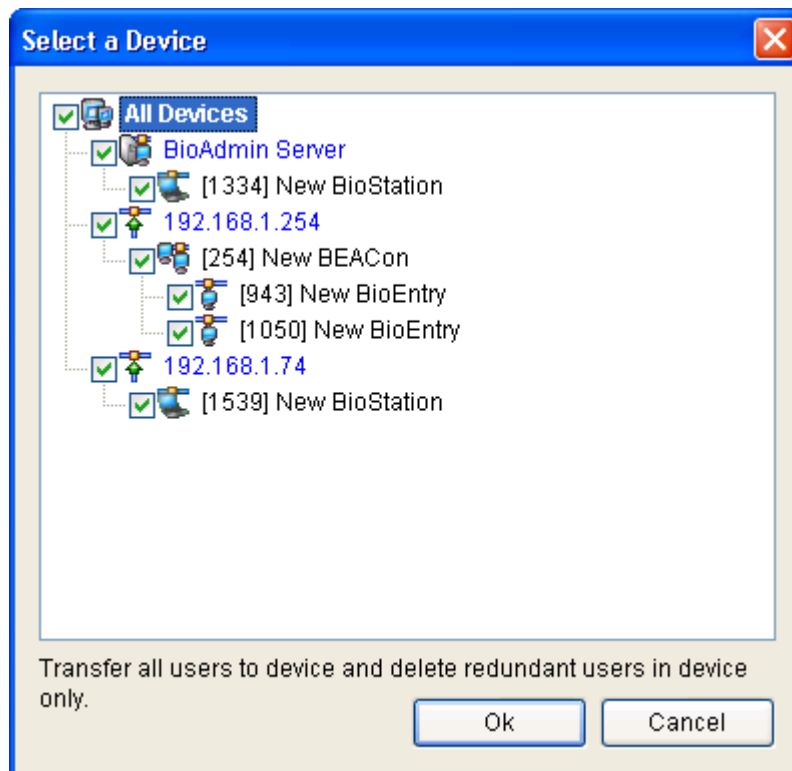

Detailed operating process is as follows.

- Press **synchronize all users** button.
- Select applicable device on device list window.
- Press select button to transfer user information database in device from host PC to device.

Note : By transferring all users to device, surplus users in devices will be deleted.

## 4.12. Export to file

The **Export to file** button initiates saving information of selected users in CSV format. Fingerprint templates are not included in this exportation. Exported CSV file

can be edited using Microsoft Office Excel or usual text editor.

Detailed operations are as follows.

- Check on the users to export.
- Press the **Export to file** button.

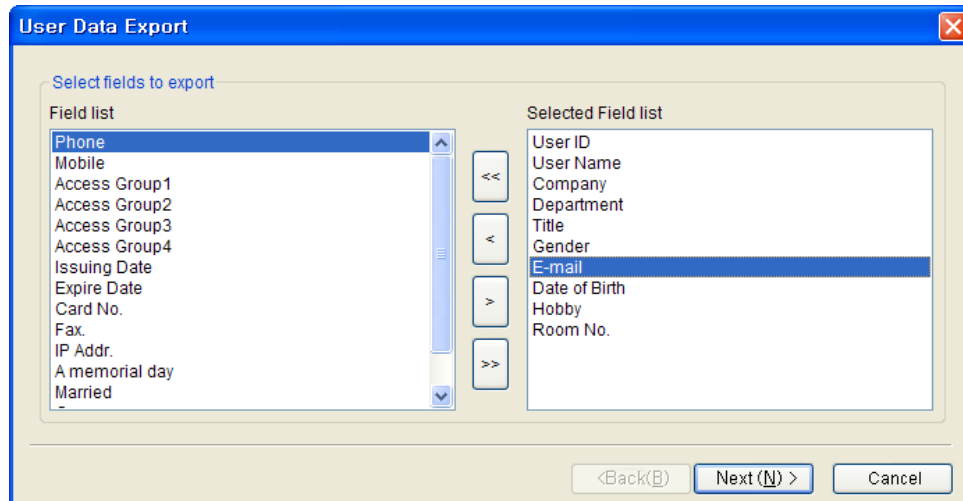

- Select fields to export. You can select the target fields simply by moving the target fields from Field list to Selected Field list.
- After selecting the fields, press the **Next** button.
- Select a file to export.
- After selecting the file, press **Next** button.
- Press **Export** button.

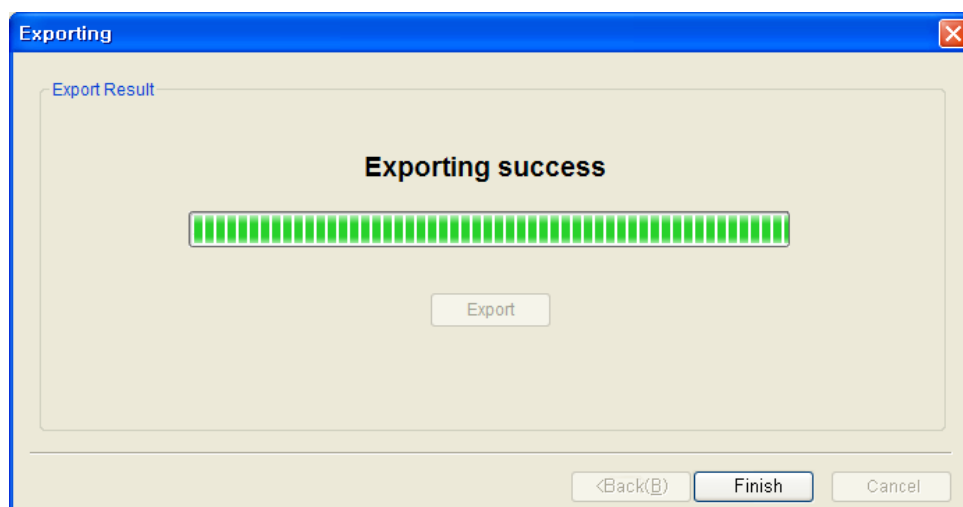

## 4.13. Import from file

The **Import from file** button is used to upload user database from an external database to BioAdmin Software user database. User list saved as CSV (Comma Separated Values) format can be loaded into user database list.

Detailed operations are as follows.

- Press the **Import from file** button.

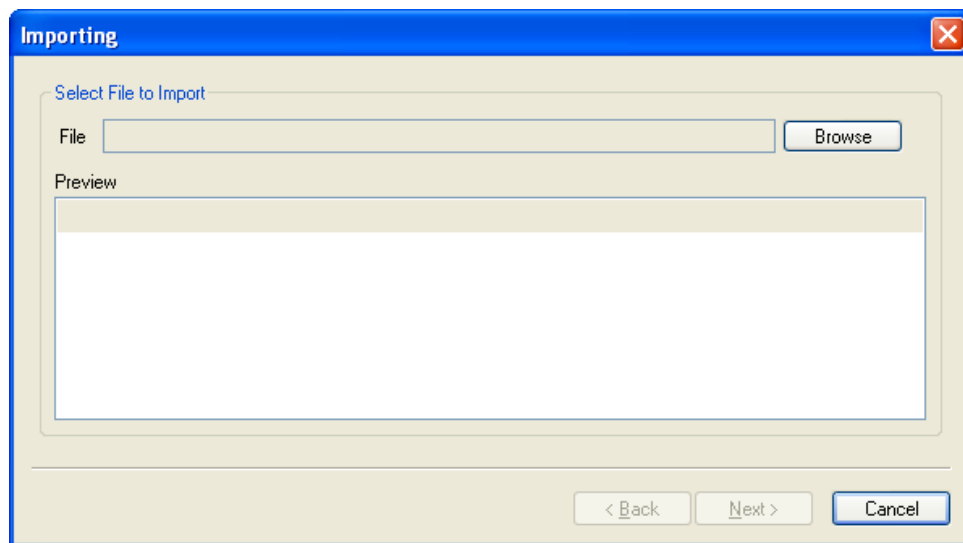

- Select a file to upload.
- After selecting the file, you can see the content examples of 5 users on the preview window. Check the preview window to confirm the selected file is the right file from which you want to upload the database.

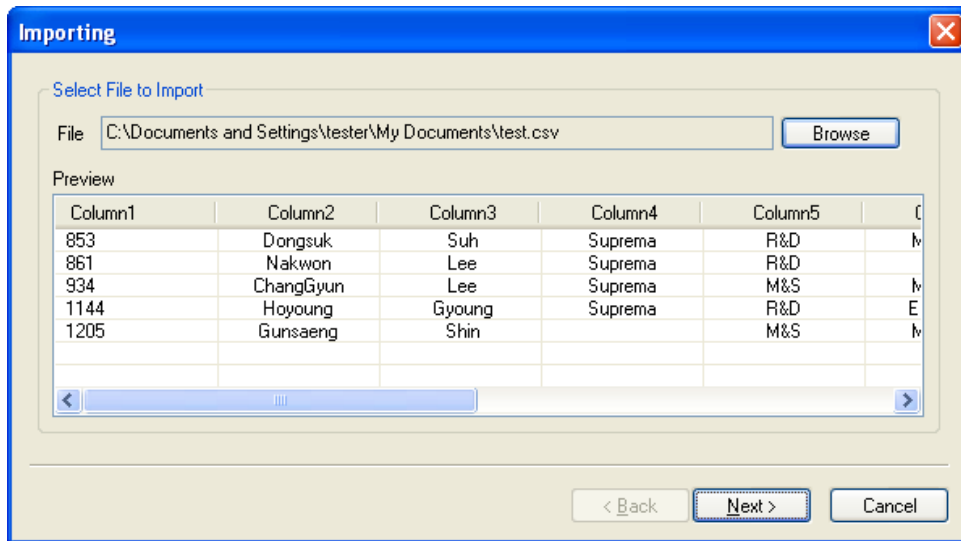

- If the file is correct, press the **Next** button.
- Select a column to upload.

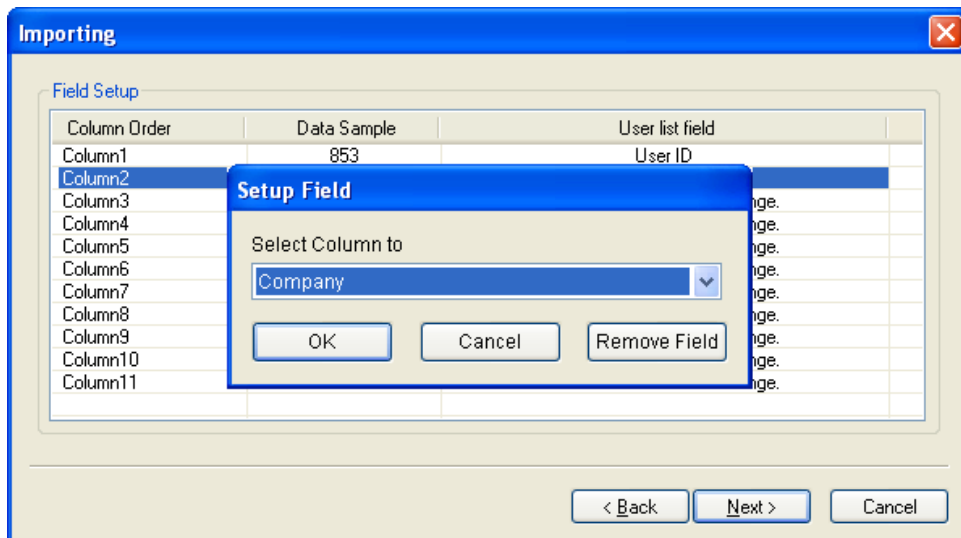

- Press the **Upload** button.

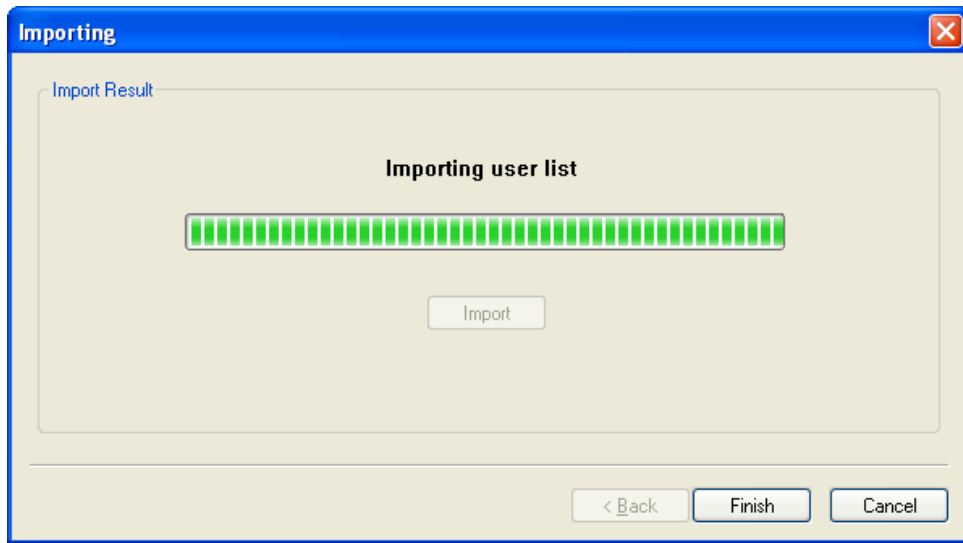

## 5. Device Management

By selecting the **Device Management** menu, the device management page is updated on the main window.

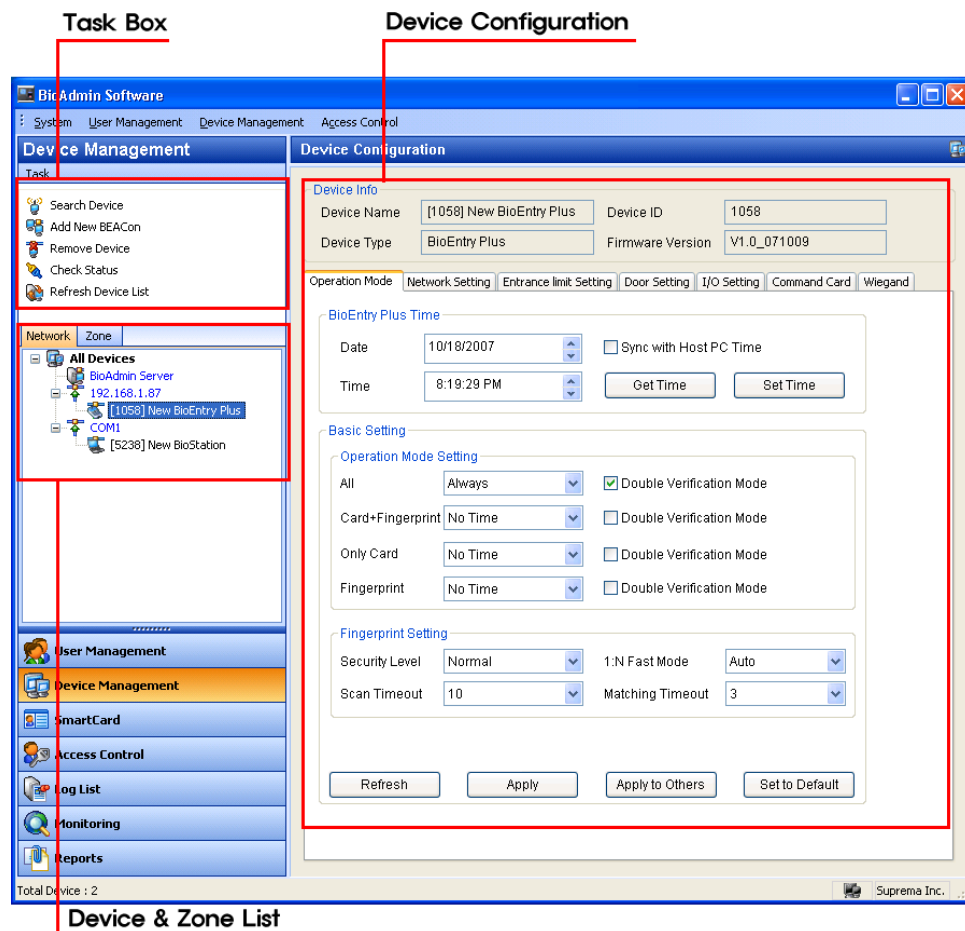

Device management page is divided into 3 sectors:

- Device configuration
 

The configuration set up window shows the current configurations of networked BioEntry, BioStation, and BEACon. Also, this window shows the configurations to be changed.
- Task box
 

The Task box includes buttons to control basic operations of the Device Management page.
- List Window
 

List Window divides into Device List and Zone List.

“Device List” displays a list of connected devices, and it can be changed its setting value by selecting a certain device. “Zone List” displays the defined zone of the connected device. Please refer to ‘4.4 List Window’ section for further information.

## 5.1. Search New device

To search new BioStation, BioEntry, BioEntry Plus, or BioLite Net device and add, click search device menu in task box. If add new device window pops up, select a device for search from BioEntry, BioEntry Plus, BioStation, or BioLite Net and select serial port, TCP/IP (Ethernet) or USB device according to interface between device and host PC. The USB connection is available only with BioStation and UDP can be used for BioEntry Plus. BioLite Net is also available for UDP search, TCP/IP, and serial port communication via RS485.

### 5.1.1. Serial port

In case device and host PC are linked by serial network, set applicable COM port of host PC and select baudrate. Default baudrate of BioStation, BioEntry, BEACon, and BioLite Net is 115,200 bps.

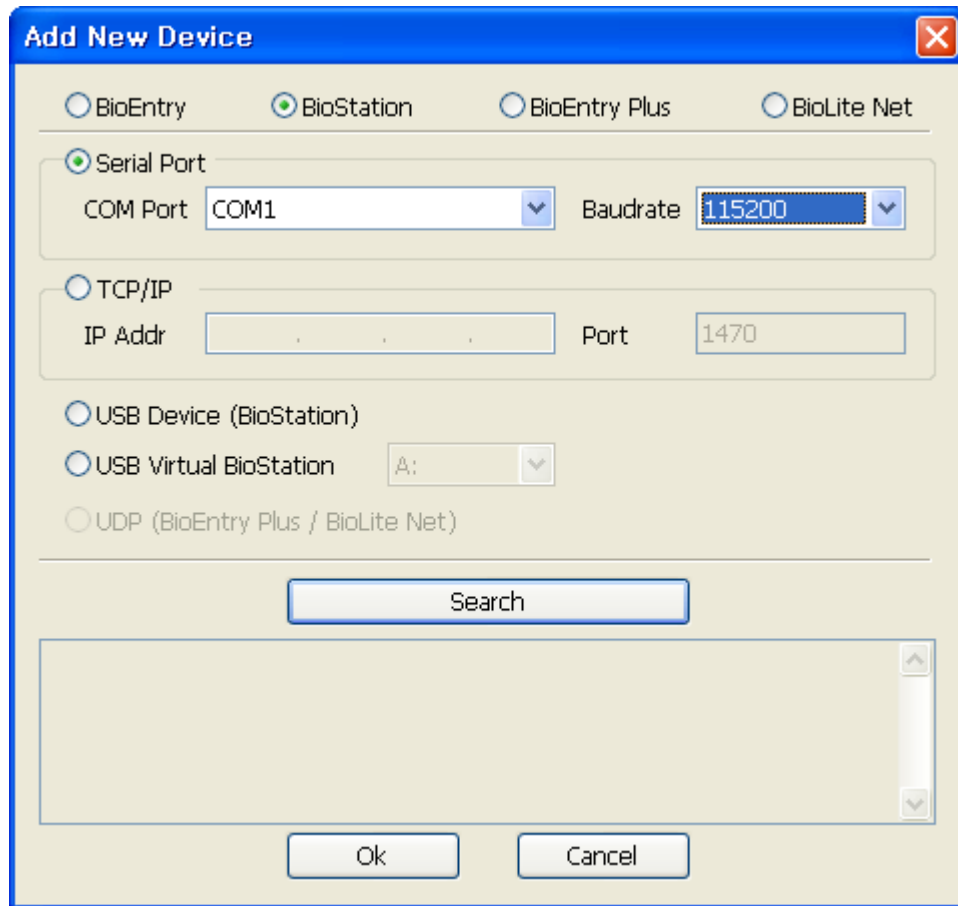

Press search button to display search result. Press ok button to display searched device on device list. The number in bracket [ ] ahead of searched device name is device ID. To change device name, place a cursor on applicable device and press the right button of the mouse to display a menu. Choose 'change name' then input window appears where a new name can be entered.

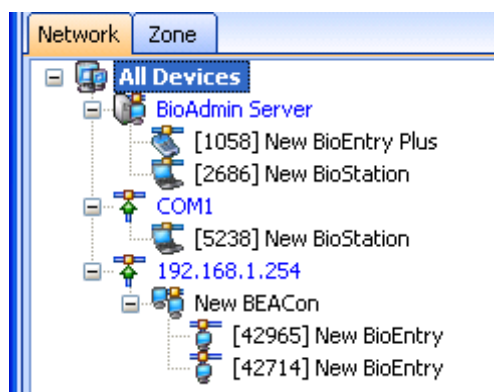



### 5.1.2. Ethernet

In case device and host PC is connected by Ethernet, enter IP address and port in TCP/IP field on add new device window.

In case of BioStation, BEACon, and BioLite Net IP address can be checked in device. For details, refer to manual of each device. In case of BioEntry, Ethernet interface is not supported but can be linked by Ethernet using Ethernet to Serial converter in host PC. Input IP address of mounted Ethernet to Serial converter.

Input 1470 for all ports.

The screenshot shows the 'Add New Device' dialog box. The 'BioStation' radio button is selected. The 'TCP/IP' section is active, showing an IP address of 192 . 168 . 1 . 136 and a port of 1470. The 'Search' button is visible, and the 'Ok' and 'Cancel' buttons are at the bottom.

Once device is linked correctly with network, searched device ID appears with bracket [\*\*\*\*] under port on device tree window.

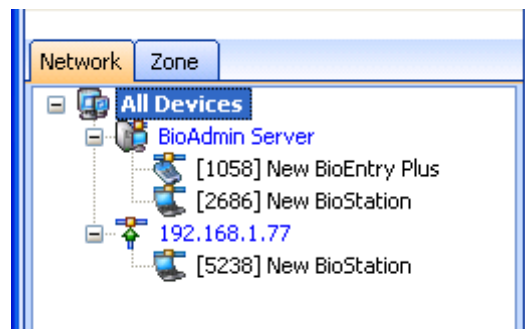

### 5.1.3. USB device

In case of connecting BioStation with host PC by USB, select USB device and search.

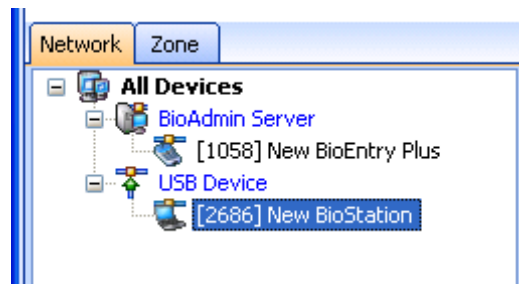

### 5.1.4. Virtual Terminal

You can use a USB memory as a virtual BioStation terminal. After connecting a USB memory to BioStation, store the necessary information such as user information, log, and various setting values of the BioStation. Then, by connecting the USB memory to the host PC, you can utilize most of the BioAdmin menus with the connected virtual terminal.



Note : To use a virtual terminal, OS of your host PC should recognize the USB memory as a correct USB drive. Thus, user should not change or remove the file in the USB drive.

You can add a virtual terminal to the network by the following procedures.

- Register a USB memory as a virtual terminal. You can do so with the **Initialize** menu of the Network / USB memory menu on BioStation. For the detailed

operation, please refer to the BioStation User Guide.

- After registering a USB memory as a virtual terminal, connect it to the host PC.
- Check whether your host PC properly recognizes the virtual terminal as a drive.
- Select the virtual terminal on the **Search Device** menu.
- Select the drive of the connected virtual terminal and press **Search** button.
- After finding the virtual terminal, press **OK** button.

**Add New Device**

BioEntry     BioStation     BioEntry Plus     BioLite Net

Serial Port

COM Port: COM1    Baudrate: 115200

TCP/IP

IP Addr: 192 . 168 . 1 . 136    Port: 1470

USB Device (BioStation)

USB Virtual BioStation: A:

UDP (BioEntry Plus / BioLite Net)

Search

Ok    Cancel



#### 5.1.5. UDP (BioEntry Plus / BioLite Net)

BioEntry Plus and BioLite Net is to add a device using UDP function rather than BioStation.

- Search new installed BioEntry Plus / BioLite Net within same network bandwidth.
- Select the detected BioEntry Plus / BioLite Net device.
- Make BioEntry Plus / BioLite Net network setting.

In case of DHCP environment, BioEntry Plus is automatically assigned IP address.

In case of not supporting DHCP environment, BioEntry Plus is temporarily assigned IP address, so network administrator has to assign valid IP address. Not to conflict with other IP address, only one device is detected and administrator has to assign each device in sequence.

**Add New Device**

BioEntry     BioStation     BioEntry Plus     BioLite Net

Serial Port

COM Port: COM1    Baudrate: 115200

TCP/IP

IP Addr: 192 . 168 . 1 . 136    Port: 1470

USB Device (BioStation)

USB Virtual BioStation: A:

UDP (BioEntry Plus / BioLite Net)

Search

Ok    Cancel

- Check mark 'UDP (BioEntry Plus)' in "Search New Device" window, click Search button, then all connected BioEntry Plus devices are detected, which may take a certain minutes depending on the network traffic or line condition. You may click Search button again for not detected devices.

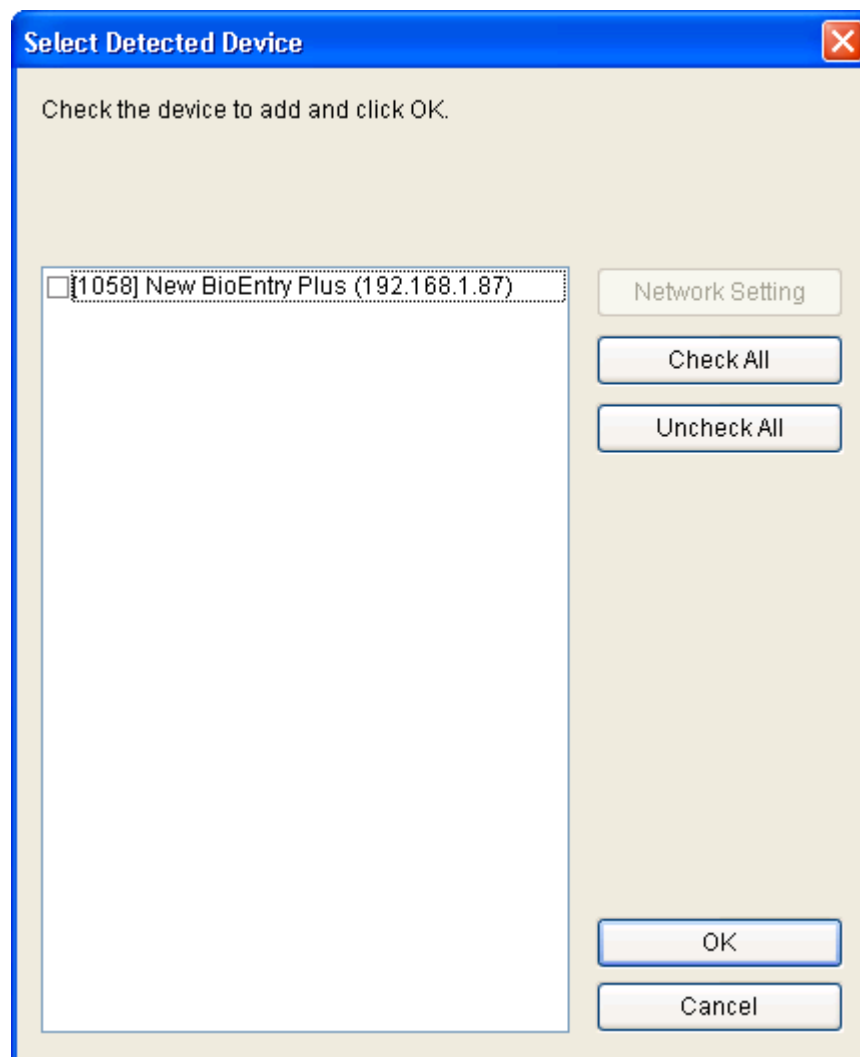

- Press OK button, then “Detected Device Selection” windows is appeared.
- Check mark new device to modify network setting
- Depending on the network environment, administrator can select DHCP or USE Server.

BioEntry Plus Network Setting

192.168.1.87(1058)

System Information

ID 1058 Refresh

MAC 00:17:fc:20:04:22 Reset Device

Network Setting

Use DHCP Save

Use Server Refresh

Time Sync with Server

IP Address 0 . 0 . 0 . 0

Gateway 0 . 0 . 0 . 0

Subnet Mask 0 . 0 . 0 . 0

Server IP 192 . 168 . 1 . 120

Port 1480

OK

- The default port of BioEntry Plus is 1471. (Can be modified)
- After finishing network setting, you can find the added new device in Device List.
- The right click of mouse button on the device is also available.

Note : In case of checking 'Use Server' in the BioEntry Plus Network Setting, please follow the below setting as:

- Server IP : IP address of PC installed BioAdmin Server program
- Port : Port number used in BioAdmin Server program (Default: 1480)

## 5.2. Add New BEACon

Searching and adding process of BEACon.

The screenshot shows the 'Add BEACon' dialog box. It has a blue title bar with a close button. The dialog is divided into two main sections: 'Serial' and 'TCP/IP'. The 'Serial' section is currently unselected, while the 'TCP/IP' section is selected. In the 'TCP/IP' section, the 'IP Address' field contains '192 . 168 . 1 . 254' and the 'Port' field contains '1470'. Below these fields is a section titled 'New BEACon' which contains four text input fields: 'BEACon ID' (value: 1), 'BEACon Name' (value: New BEACon), 'BioEntry #1' (value: 42714), and 'BioEntry #2' (value: 42965). A button labeled 'Update Attached BioEntry' is positioned to the right of the 'BEACon ID' field. At the bottom of the dialog are 'OK' and 'Cancel' buttons.

Detailed operations are as follows.

- Press the Add New BEACon button on the task box.
- Select the communication method between Serial and TCP/IP.
- In case of serial, set COM port and network baudrate and in case of TCP/IP, input IP address of BEACon to add. For how to check IP address in BEACon, refer to BEACon manual.
- Input BEACon ID to add in BEACon ID field. For how to check ID in BEACon, refer to BEACon manual.
- Designate and input BEACon name in Name field.
- If you press update attached BioEntry button, it starts searching applicable BEACon and linked BioEntry device.
- As a result of search, linked BioEntry ID is indicated in BioEntry #1 and BioEntry #2 fields. In case of failing to search BEACon due to wrong input of IP address



or ID, none is indicated here.

- Press ok button to view searched BEACon and linked BioEntry on device list.

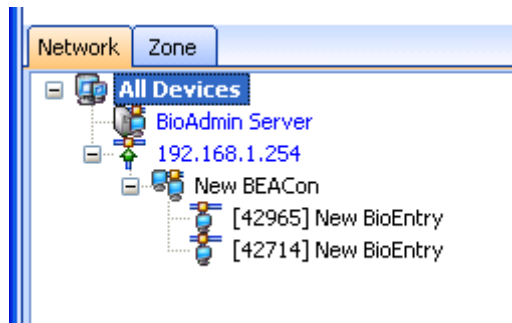

### 5.3. Remove device

- Select a device on task list and click **Remove Device** on task box to remove the selected device. You can also remove a device by selecting a device on device list and clicking a right button of the mouse.
- You can remove virtual terminal from the network by the following procedures.
  - Select a virtual terminal on the device tree and click the right button of your mouse.
  - Safely Remove USB Memory: Click this menu to detach the virtual terminal from your host PC after storing data on it. If you detach the virtual terminal while storing or using data, it can cause a data loss from the virtual terminal
  - Delete All Device From USB Memory: Remove the data of all virtual terminals from the USB memory. To use the USB memory again as a virtual terminal, you need to register the USB memory as a virtual terminal.
  - Delete Device from USB Memory: Remove the data of the selected virtual terminal from the USB memory.

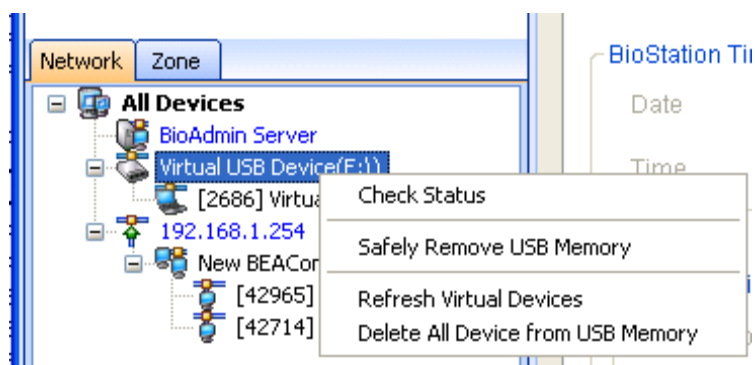

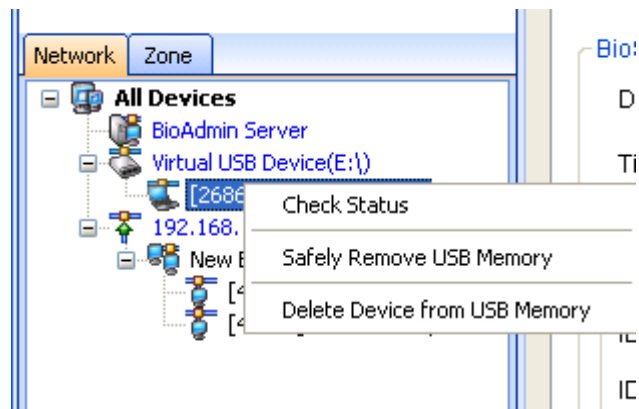

## 5.4. List Window

List Window divides into Device List and Zone List.

“Device List” displays a list of connected devices as Icon type and “Zone List” displays the defined zone of the connected device.

### 5.4.1. Device List

- If Device List is connected, icon is active.

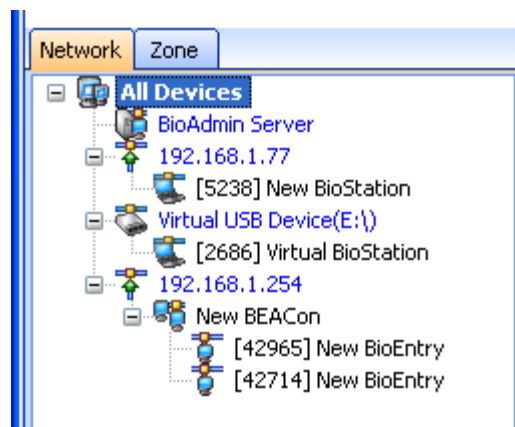

- If Device List is not connected, icon is inactive.

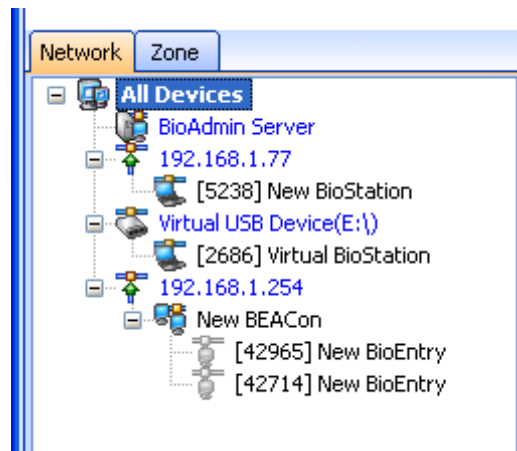

Status of each device is updated in case of the followings.

- When BioAdmin software starts
- When a device is selected anew
- When clicking check status menu
- When connecting BioStation to host PC via USB
- 

#### 5.4.2. Zone List

- Zone List can be configured as some grouping to manage and control connected each device, then display a list. If you click “Zone List”, you can see zone list combination of each device. In case of no Zone setting, it display as “Stand Alone” in the sub device.

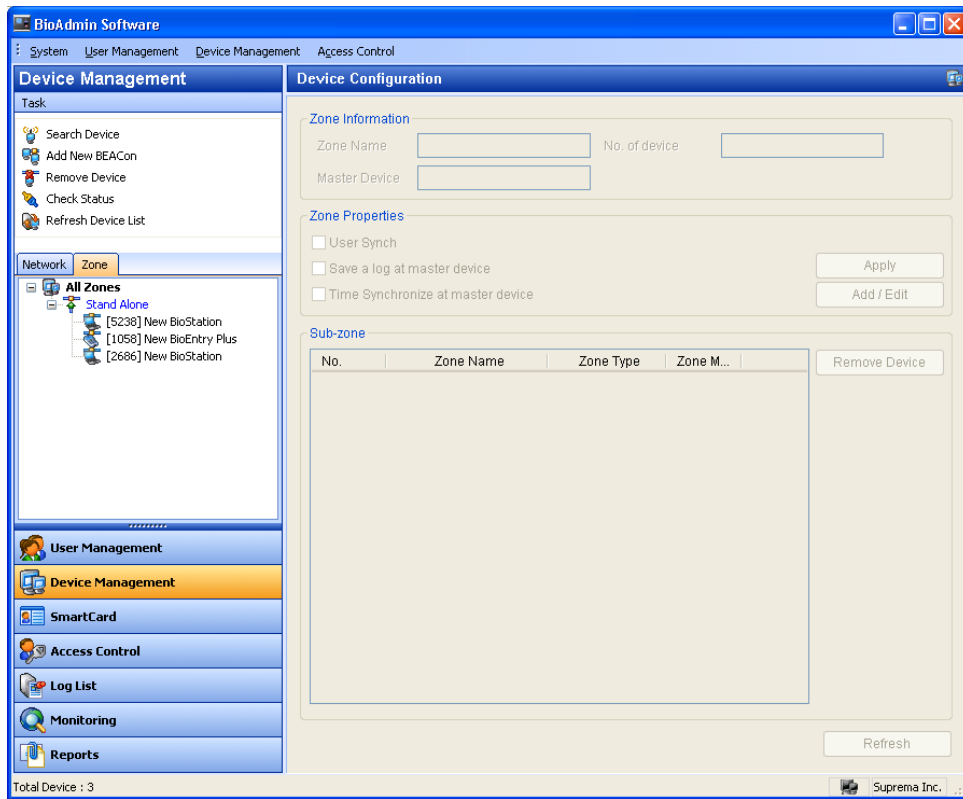

- Add a Sub Zone

- Click right button of mouse on the device to make Master Device for a zone, and you will see “Create New Zone”, and click it.

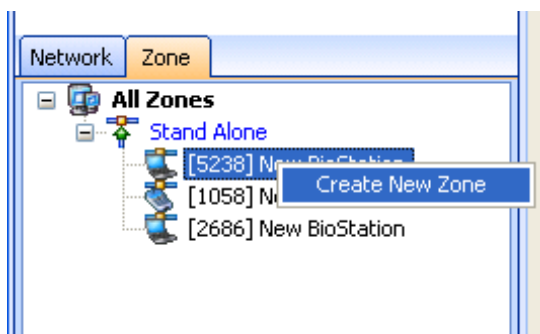

- Type “Zone Name” as you want and select a device as Master Device
- Check a mark a device to be Zone Member and press Next button.

**Zone Management**

Zone Name: New Device Group

Master Device: [5238] New BioStation

Zone Member:

- [1058] New BioEntry Plus
- [2686] New BioStation

< Back   Next >   Cancel

- You can select synchronization what you want among same zone device.

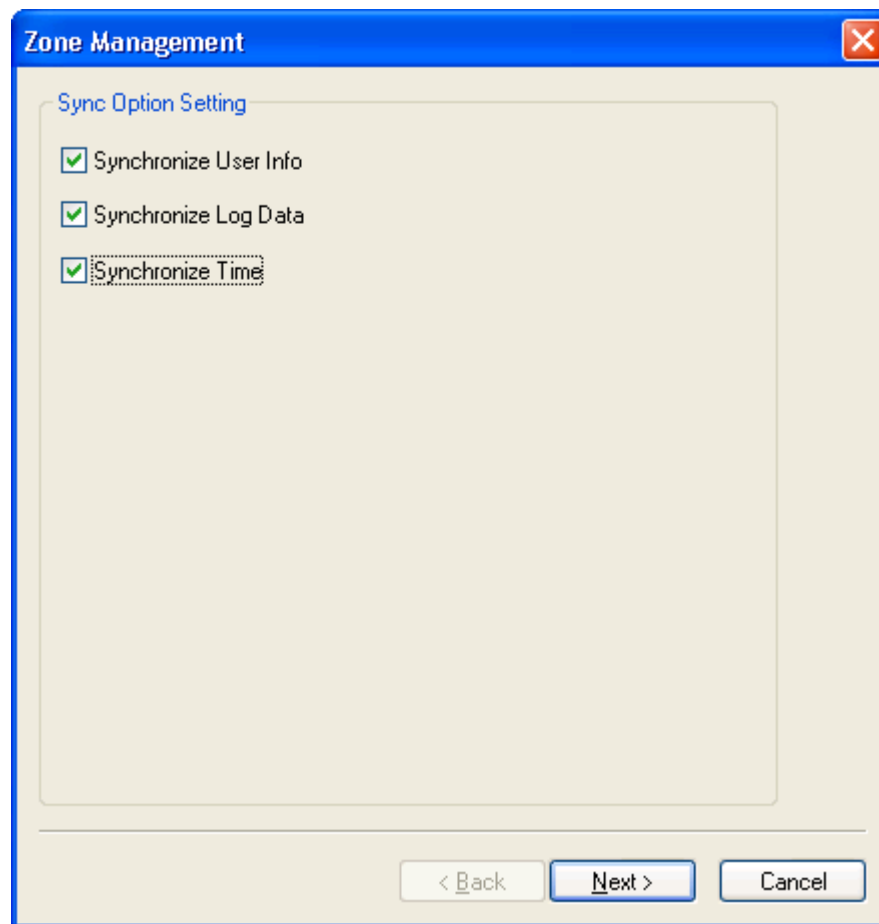

- Select Sub Zone whether it is APB, Entrance Limit, or No Sub Zone.

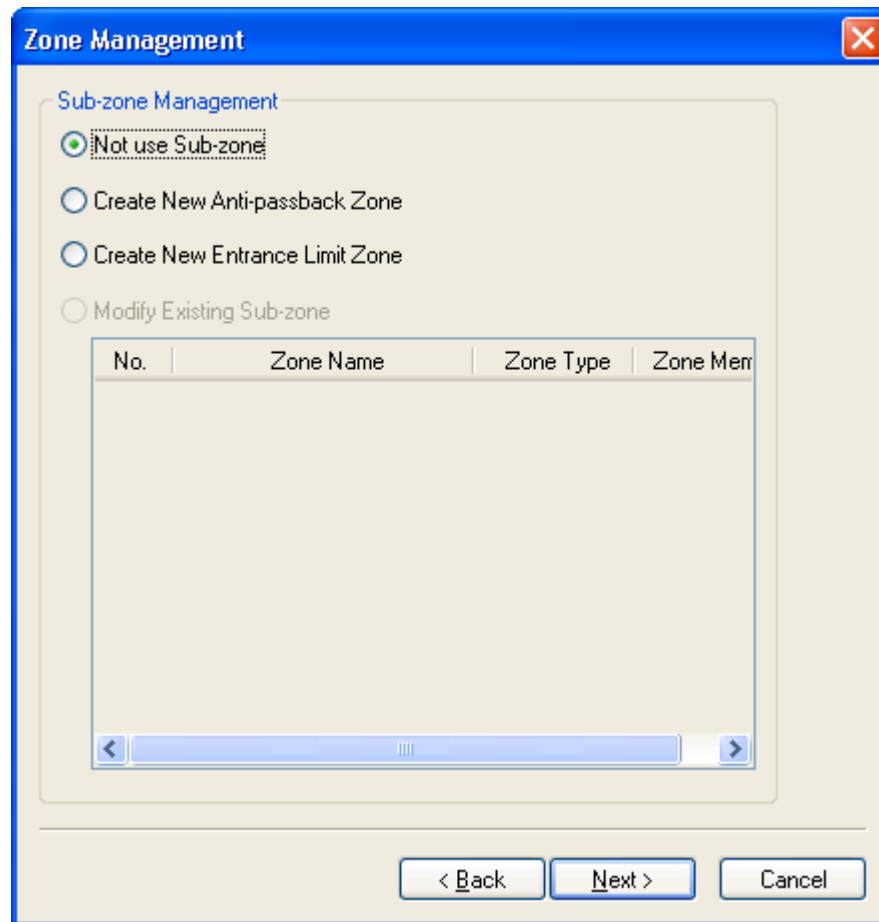

- (For the purpose of synchronization only within same zone device, please select 'Not use Sub Zone'.

Zone Management

Created New Zone

Press Finish to transfer data to each device

Zone Information

Zone Name: New Device Group

Master: [5238] New BioStation

Sub-zone

Device	Zone	Zone Type
2686		
1058		
5238		

< Back   Finish   Cancel

- APB (Anti PassBack) Zone information divides into for Entrance and Exit.



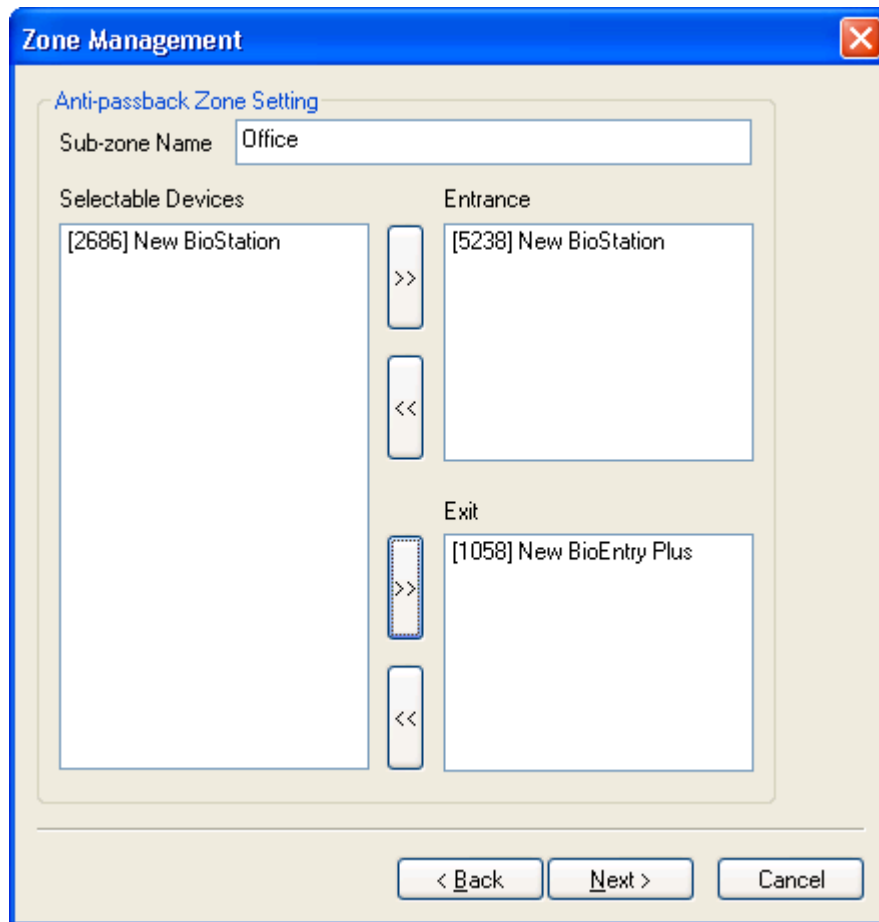

- Only user who has fingerprint verification successful for Entrance device can be verified for the Exit device, which is used to manages entrance members.
- Entrance Limit Zone setting can be applied for entrance limit function at once based on synchronized entrance log within same zone devices.

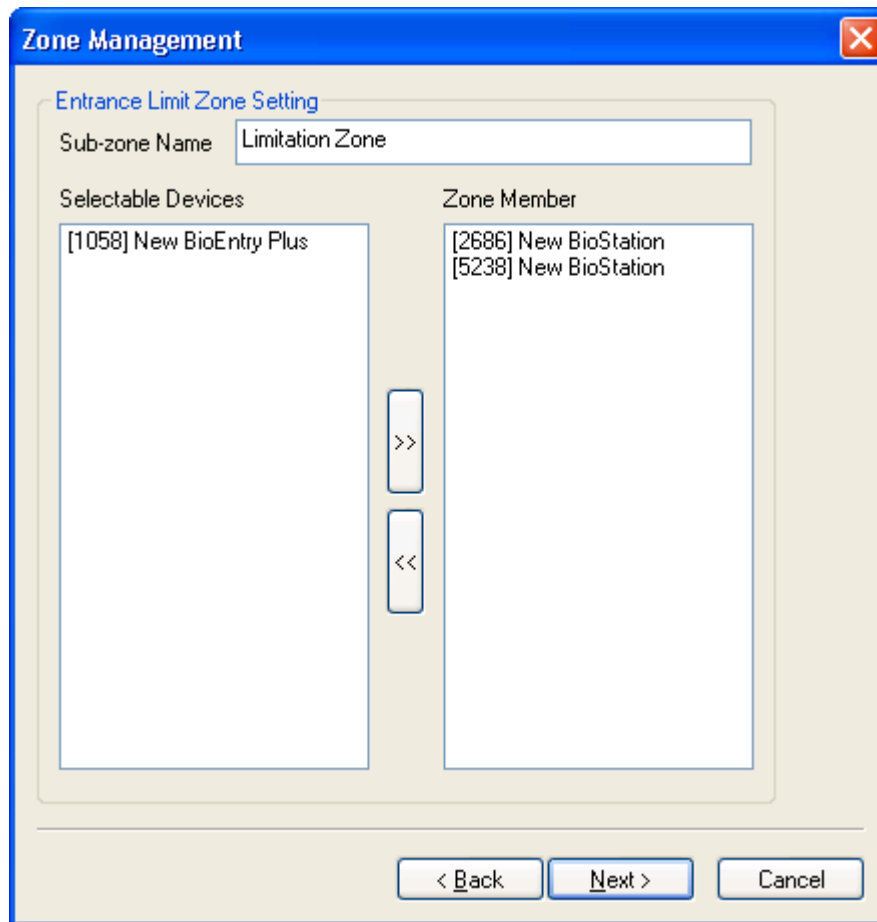

- If a setting is limited for repeat entrance within same zone devices, other devices follow the same setting, which deny repeat entrance though a user is successful for entrance within same zone devices.
- Select a device from “Zone Member Device” and press Next button.

**Zone Management**

Entrance Limit Zone Setting

Sub-zone Nam: Limitation Zone

Entrance Limit By Time Period

Checked	Start Time	End Time	Max Number of Entrance
<input checked="" type="checkbox"/>	0900	1000	3
<input type="checkbox"/>	0000	0000	0
<input type="checkbox"/>	0000	0000	0
<input type="checkbox"/>	0000	0000	0

30 : Time Limit for Re-entrance (min) (0: No Limit)

< Back   Next >   Cancel

- You can type 'Entrance Limit By Time Period' and 'Max. Number of Entrance'.
- You can also set minimum time in minute to allow repeat entrance.

## 5.5. Manage BioStation device

If you select BioStation on device list, the device setup window of selected BioStation is updated on main window.

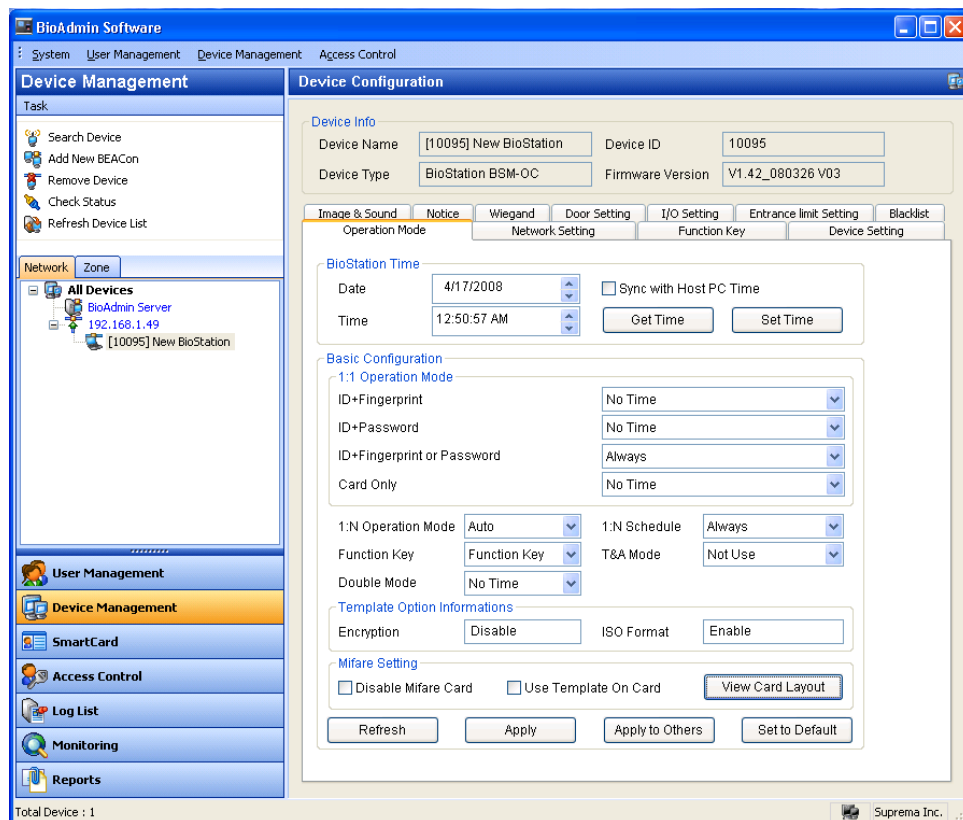

Device setup window is divided into 2 areas.

- **Device information**  
Device information displays type, name, serial number and FW version of selected device.
- **Configuration window**  
Configuration window shows settings of selected BioStation device and enables user to correct those settings. Configuration menu consists of separated tabs, i.e. operation mode, network, setting, function key, device setting, image & sound, and notice.

At lower part of configuration window are 4 buttons, i.e. refresh, apply, apply to others and set to default.

- **Refresh** : call device setting again.
- **Apply** : apply corrected setting on the current window to device.
- **Apply to others** : apply corrected setting on current window to another device. Device can be selected on select device window.

- **Set to default** : change setting as default. To apply this value to device, make sure to press apply button.

### 5.5.1. Device information

You can check device name, device type, device ID and firmware version of selected BioStation. Device ID number and firmware version are necessary information to check a product for technical support after installation.

Device Info			
Device Name	[5238] New BioStation	Device ID	5238
Device Type	BioStation BSR-OC	Firmware Version	V1.4_071008 V03

- Device Name
- Device Type
- Device ID
- Firmware Version

### 5.5.2. Operation mode

- Time setting

Date and time shown first are those read from BioStation. If you click get time button, it reads date and time from BioStation once again.

Method of BioStation time change is divided into direct input and synchronization with current PC time.

- Direct input : either input numbers directly in date and time window or place a cursor on a number and click up/down arrow keys for input. Press set time button after input to transfer input date and time to the selected BioStation.
- Synchronization with PC time : check **sync with current PC time** and set time button, then selected BioStation time is set by current PC time.

BioStation Time			
Date	8/ 8/2006	<input type="checkbox"/> Sync with Host PC Time	
Time	11:00:43 AM	<input type="button" value="Get Time"/>	<input type="button" value="Set Time"/>

- Basic Configuration

- 1:1 Operation Mode : if you select 1:1 operation mode on BioStation, user ID should be suggested first and then the user should authorized himself with his fingerprint or password, which can be assigned by pre defined 'Time Zone' of "Access Control" at main menu. Please refer to "6.1 Time Zone Setting" (Time Zone should be transferred to all devices to select in 1:1 operation mode). Default is 'Always' or 'No Time'.

'Always' can be selected only one in below.

- ID + Fingerprint
- ID + Password
- ID + Fingerprint or Password
- Card Only

1:1 Operation Mode

ID+Fingerprint	No Time
ID+Password	No Time
ID+Fingerprint or Password	Always
Card Only	No Time

- 1:N Operation Mode : in 1:N Operation mode, user is authorized by fingerprint without user ID input. About how to start fingerprint input, user can choose one of 3 modes, i.e. auto, OK button/Function Key and none.
  - **Auto** mode : Because BioStation sensor is always on as standby mode, scan starts right after a finger is placed on the sensor.
  - If you choose **OK button** or Function Key button mode, you have to place a finger after pressing OK button or Function Key button on BioStation when entering fingerprint.
  - In case of not using 1:N mode but using 1:1 mode only, choose **None** mode.

1:N Identification	Auto	1:N Schedule	Always
Function Key	Function Key	T&A Mode	Not Use
Double Mode	No Time		

- 1:N Schedule : Select time zone of 1:N Operation mode, which can be also assigned by pre defined 'Time Zone' of "Access Control" at main menu. Please refer to "6.1 Time Zone Setting" (Time Zone should be transferred to all devices to select in 1:N operation mode).
  
- T&A function key : T&A function key is to enter T&A event before entering fingerprint for T&A control such as in, out, in duty, out duty. In BioStation, usually from F1 to F4 function keys are used for this and, if necessary, function key can be increased up to 16 keys. T&A key mode can be chosen from **function key** mode and **none** mode. In case of using BioStation for exclusive use of access control, choose none while in case of using for T&A control, choose function key. Pressing T&A key on BioStation first and then enter fingerprint to record applicable T&A event in a log. In the future T&A software, this log information can be used for various T&A and salary control data.
  
- T&A Mode : BioStation Function Key can be changed by below
  - Auto : T&A mode is automatically changed by pre defined function key of BioStation. If selecting this Auto mode and go to 'Function Key' tab, you will see highlighted 'Auto Mode' You can also select 'Time Zone' of "Access Control" at main menu.
  - Manual : If a user verify by pressing T&A Function Key, its function key keeps same function to the following users until disabling manual mode.  
Please pay attention to when you select manual mode!!
  - Fixed Key: If selecting Fixed mode and go to 'Function Key' tab, you will see highlighted 'Fix' check box. For example, if you fix 'F1' key, it is not necessary to push 'F1' key, but just paste your finger to work for 'F1' function.
  
- Double Mode : In case of verifying two user's fingerprint, it is possible to

send relay for door opening or siren, which is special option for higher security level.

- Always
- No Time
- Defined 'Time Zone' of "Access Control"

Note : Double mode is specially designed for two user's verification for secure access control. Please pay attention to select this mode!

● Template Option Information

Template Option Informations

Encryption	<input type="text" value="Disable"/>	ISO Format	<input type="text" value="Enable"/>
------------	--------------------------------------	------------	-------------------------------------

- Encryption : Enable or Disable
- ISO Format : Enable or Disable

Note : Go to System->Preference Menu to make availability by selecting 'Security Option' and 'Template Format Option.'





In case of changing settings such as various modes, changes are applied only after apply button is pressed.

● Mifare Setting ( Mifare Model Only )

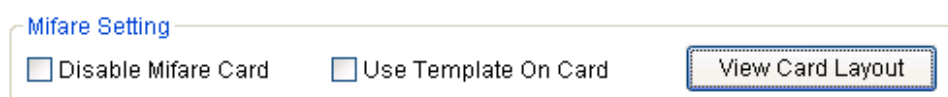

- Disable Mifare Card :Not to use Mifare feature
  - Use Template On Card : Determine whether user information is stored on

the Mifare card by selecting it.

- View Card Layout : Display Mifare Layout stored on the current BioStation. Please refer to the “6. Smartcard / Mifare card” for Mifare Layout.

### 5.5.3. Network setting

This window shows setup for various networks of a device. As per interface methods, it is divided into LAN, serial, and USB.

#### ● LAN

In network setup list box at upper part of a window, set whether or not to use LAN and if yes, whether to use cable LAN or wireless LAN. Specify a port as 1470.

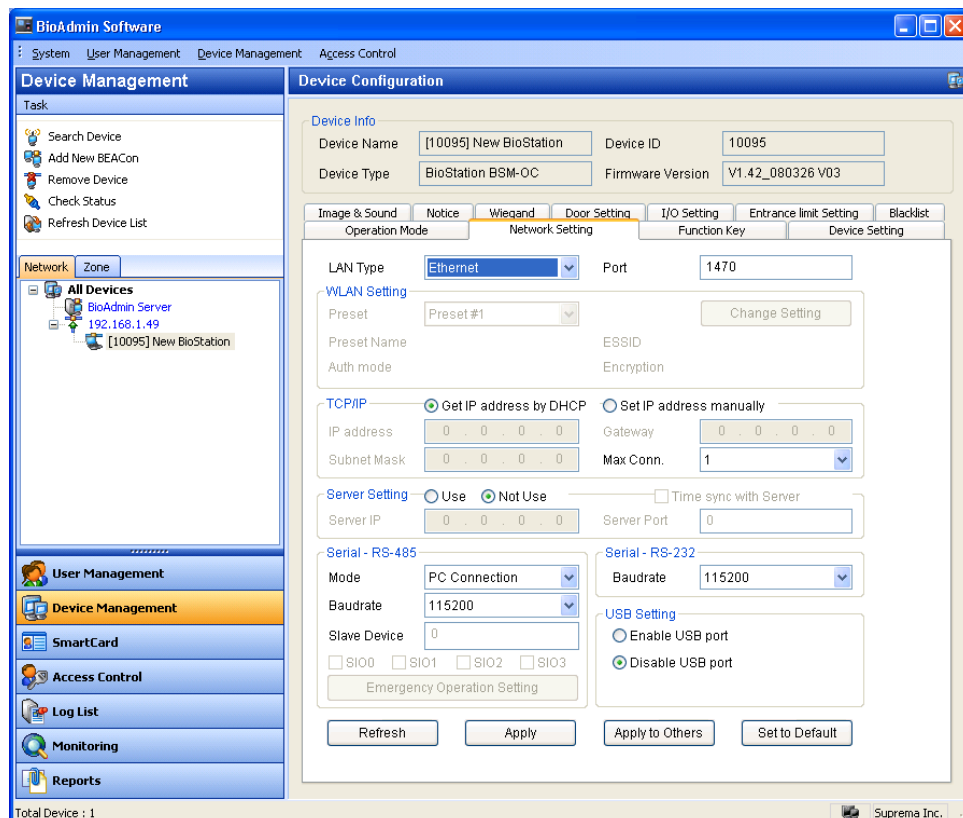

#### ● WLAN Setting

To setup the wireless network, you need the following procedures.

First, you need an access point. Each access point has its own SSID, and, in some cases, it use the data encryption. BioStation supports WPA\_PSK and

WEP as the data encryption methods. Refer to the manual of your access point device and check whether it is using the data encryption. If yes, you need to check the type of the data encryption.

WLAN Setting

Preset	<input type="text" value="Preset #1"/>	<input type="button" value="Change Setting"/>
Preset	bio_linksys	ESSID bio_linksys
Auth mode	Open System	Encryption WEP

- Preset: To activate the wireless network, you should select one of the 4 preset. Of course, you can not use the wired LAN upon using wireless LAN function.

BioStation WLAN Setting

Preset Name	<input type="text" value="bio_linksys"/>
ESSID	<input type="text" value="bio_linksys"/>
<b>Wireless Network Key</b>	
Network Authentication	<input type="text" value="Open System"/>
Encryption Strength	<input type="text" value="WEP"/>
Network Key	<input type="text" value="....."/>
Confirm Key	<input type="text" value="....."/>

- Preset Name: preset name is displayed on the BioStation using WLAN setting.
- ESSID: ESSID is the unique ID of the access point. To check the ESSID of your access point, refer to the manual of your access point or ask your network administrator.
- Auth mode: You can select the network authentication open system,

shared key and WPA-PSK. It must have same setting to authentication of access point. You can see this setting on security page in access point setup application.

- Encryption Strength: You can select the encryption strength between WEP and WPA-PSK. By selecting WEP or WPA-PSK, you can encrypt the communication data between access point and BioStation.
- If the BioStation is too far from the access point, or there is an obstacle between BioStation and access point, the network can be interrupted. Also, the wireless network may not be successful due to the unique characteristics of the access point. Thus, it is highly recommended to have another network method rather than wireless LAN.

- TCP/IP

- **Get IP address by DHCP : Use Dynamic IP address**
- **Set IP address manually : Use Static IP address**
- In BioStation settings, choose whether to get IP address automatically or set manually.
- In case that IP address is automatically assigned to DHCP in BioStation, check 'get IP address automatically'. In case of not using DHCP, check 'set IP address manually' and set IP address, gateway, subnet mask. Changing LAN setting like this is required to set IP address in order to connect Serial or USB linked BioStation by LAN or to change IP address of BioStation connected by LAN to another address.
- **Max Conn.** means the maximum number of host PCs. Server-Client application is available only when the system is networked through Ethernet. If the system operates as server-client, users can operate the BioAdmin Client program from multiple host PCs. However, if the system is not operated as BioAdmin Server-BioAdmin Client but connected just as normal Ethernet, there will be a limit to the maximum number of host PCs to operate BioAdmin at the same time. For example, if you select this menu as 4, you can operate the BioAdmin program on 4 host PCs at the same time.

- Server Setting

This menu shows that the BioStation is connected to the server.

You can connect the BioStation to the server by checking on Use option and entering the server IP and server port.

If you connect a BioStation to the server, existing Ethernet connection of the BioStation is disconnected and the BioStation is connected to the server. It may take a few minutes to reconnect to the server depending on the network condition.

If you check on the **Time sync with Server**, the time of BioStation will be automatically set as the time of the server.

If the network between a BioStation and BioAdmin Server is not stable, you can reconnect the BioStation to the server. Select the BioAdmin Server on the device tree window of Device Management menu and press the right button of your mouse. Press the **Reconnect Server** menu. You can also find this **Reconnect Server** menu on the System menu of Command Menu Bar.

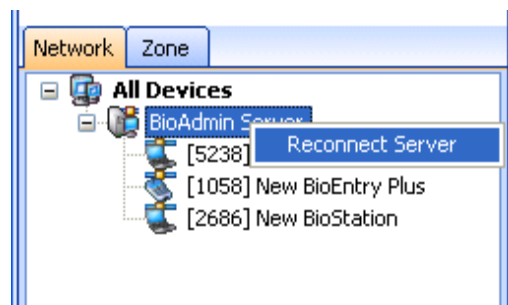

- Serial RS-485

Use for RS-485 communication of BioStation. In RS-485 mode, the connected devices take a role as 'Host' and 'Slave'. Suprema's new total integrated system including BioStation, BioEntry Plus, and Secure I/O are consist of 1 host device, 1 slave device, and max. 4 Secure I/O. Host device has total 10 relay and 20 input. Please refer to the "Secure I/O Installation Guide" for further information.

- Mode : PC Connection, Host, Slave, None
- Baudrate
- Slave Device
- SIO default Setting

**Emergency Operation Setting**

Device: Secure I/O #0

**Input**

Port: Input #0

Switch Type: N/O

Duration(ms): 0

**Output**

Port: Output #0

High(ms): 0

Low(ms): 0

Count: 0

Save Cancel

- Here are some examples of RS-485 connection

**Case #1 :** BioStation at outside door and BioEntry Plus at inside

- Generally, inside installed device sends open-relay for secure purpose, so BioEntry Plus sets as 'Host' and BioStation sets as 'Slave' via RS-485 connection.
- 1. Go to 'Network Setting' of BioEntry Plus.
- 2. Select 'Host mode' in RS-485 setting.
- 3. Type ID number of BioStation as a slave.
- 4. Go to 'Network Setting' of BioStation.
- 5. RS-485 should be 'Slave' in RS-485 setting.

**Case #2 :** BioStation at outside door and Secure I/O at inside for high secure

- BioStation as a Host controls Input/output of Secure I/O. If verified successfully, BioStation open a door via Secure I/O.
- 1. Select BioStation as a Host and check SIO (Max. 4) to control.
- 2. Type assigned number from back side of Secure I/O. by controlling DIP switch.
- 3. Control door or siren via basic In/Out of Secure I/O.

- Serial RS232

Set baudrate of BioStation's RS232 ports. Default is 115,200 bps. As to serial, in case of any trouble in condition of cable, lowering baudrate can be a solution.

- USB Setting

Select whether or not to allow connection with host PC via USB port of BioStation. As USB port is exposed to outside, in some cases, connection is not allowed for security reason.

#### 5.5.4. Function key

Function key is to input T&A event before fingerprint input for T&A control such as in, out, in duty or out duty. In BioStation, usually, function keys from F1 to F4 are used and if necessary, it can be increased up to 16 keys. Pressing function key on BioStation first and then enter fingerprint to record applicable T&A even in a log. In the future T&A SOFTWARE, this log information can be used for various T&A and salary control data.

In respect of function key in BioAdmin software, reference needs to be made to all explanations on T&A event rule in both device management menu and report menu.

Function key setting in device management menu is to set T&A event message shown on BioStation display whereas T&A key setting in report menu is to set T&A event message applied when creating T&A report. In BioStation log, actual T&A event message is not recorded but the number of pressed T&A key is recorded. BioAdmin reads this value, refers to the table between previously defined function key and T&A event and generates suitable T&A report. Thus, function key set in this chapter doesn't show in an actual BioAdmin report or upon log check.

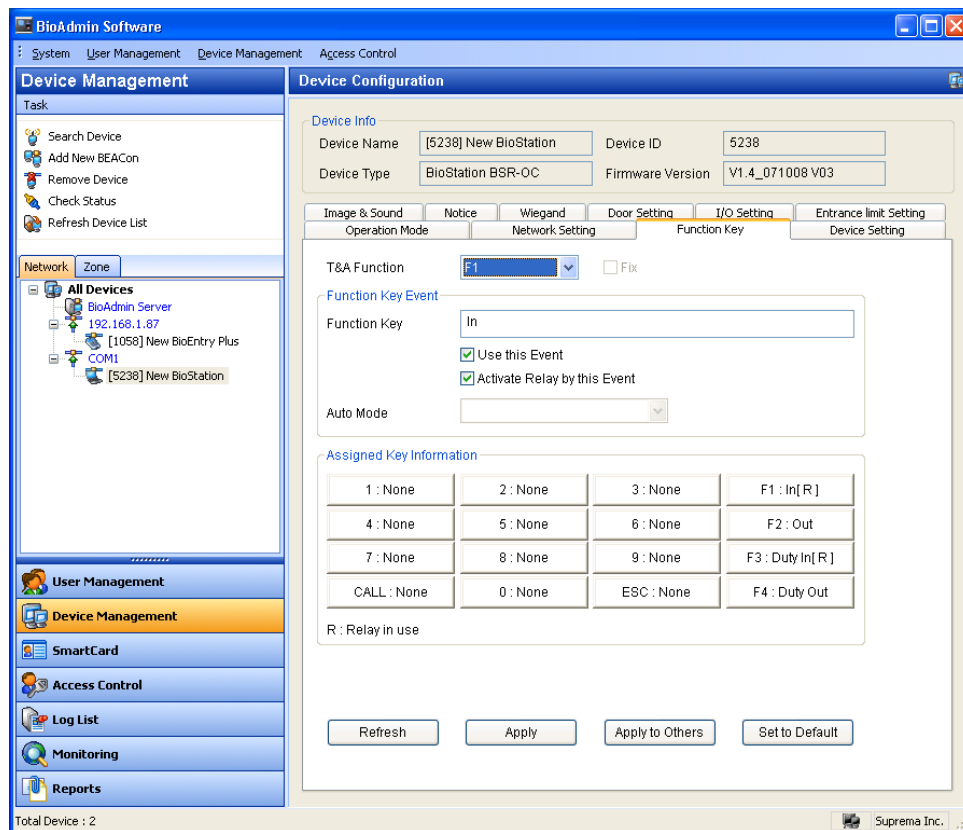

Set 16 keys in device and choose one out of 16 function keys to check function key event message displayed on BioStation LCD, use of this function key and relay use.

- Choose a function key to set.
- Enter event name in 'Function Key' field.
- Decide whether or not to check **use this event**.
- Decide whether or not to check **activate relay by this event**. Relay is usually linked to door lock control device and used to open/close a door.

Note : In case of selecting T&A mode as 'Fixed' at 'Operation Mode' tab, you will see highlighted 'Fix' check box, which is useful for T&A management.

Note : In case of selecting T&A mode as "Auto" at 'Operation Mode' tab, 'Auto Mode Schedule' is highlighted.

Please refer to "6.1 Time Zone Setting" for definded Time Zone.

### 5.5.5. Device Setting



This window is to check and change various settings of BioStation

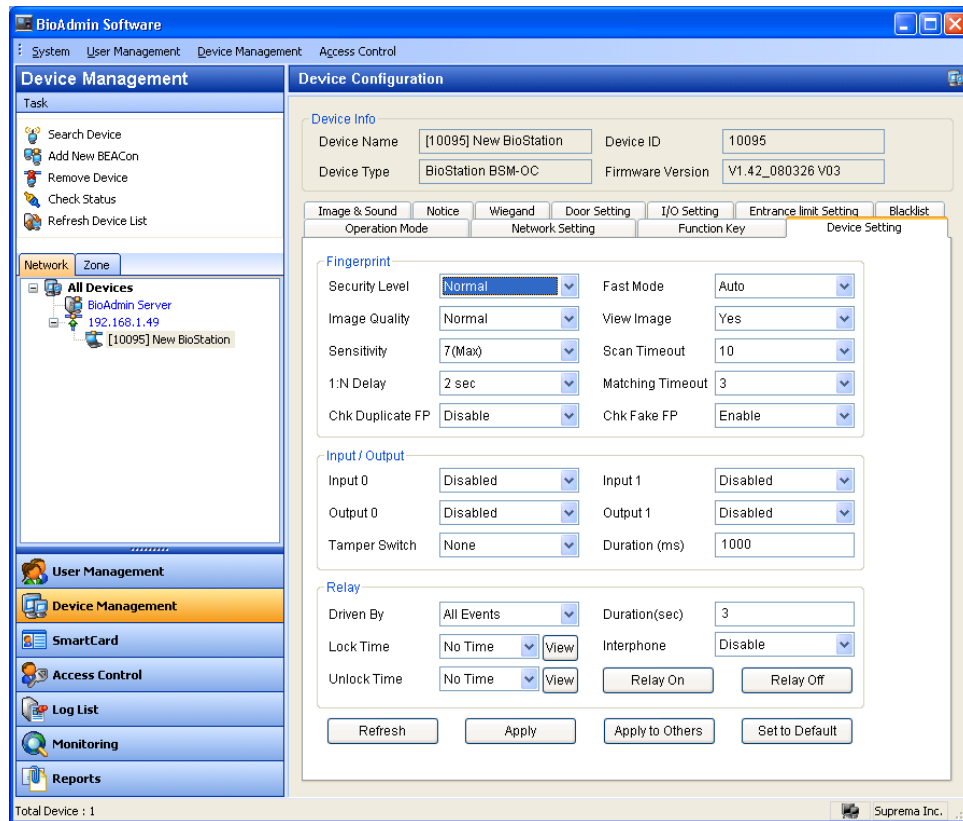

● Fingerprint

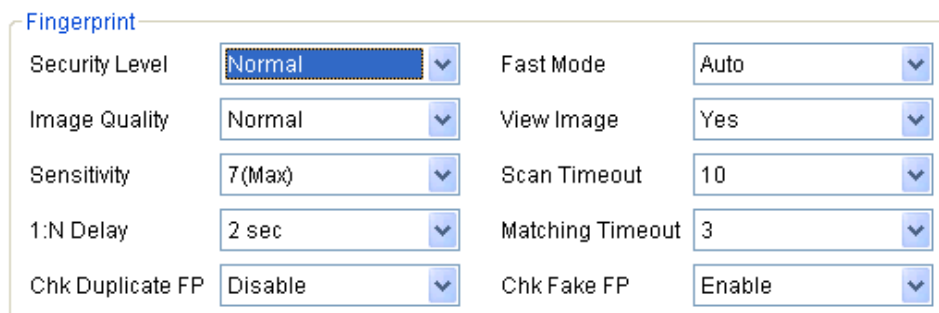

- **Security level :** Security level can be chosen among normal, secure, and most secure. Internally security level adjusts FAR(False Acceptance Ratio). As FAR and FRR(False Rejection Ratio) are in inverse proportion to each other, the higher security level is the more FRR increases, so does FRR. Default is normal.

- **Image quality** : Decide standards by which the quality of input fingerprint image is over certain level. You can choose from weak, normal, and strict. Default is normal.
  - **Sensitivity** : Sensitivity decides sensitivity of detecting a finger. In high sensitivity, finger input is accepted more easily but if sensitivity is lowered, input fingerprint image gets more stable as fingerprint is captured only when fingerprint covers more than a certain part of a finger. In case of optical model, sensitivity can be moderated by lowering setting of sensitivity against the rays of the sun. Default is 7 (Max)
  - **1:N Delay** : Interval Time to take 2<sup>nd</sup> verification (Default : 2sec)
  - **Chk Duplicate FP**(Check Duplicate Fingerprint) : Check whether it is duplicate fingerprint or not when a user enroll their fingerprint, which can protect and identify same fingerprint with two IDs.
  - **Fast mode** : In case more than hundreds fingerprints are saved in device, 1:N mode may take longer. If you set fast mode as fast or fastest, performance is somewhat low but 1:N recognition can take less time. Default is normal.
  - **View image** : User can choose either to yes or no to view or hide input fingerprint image on LCD display of BioStation. Default is Yes.
  - **Scan timeout** : User can designate the standby time when entering fingerprint. If a user doesn't enter fingerprint within this time, it is construed as input failure. Default is 10 sec.
  - **Matching Timeout** : After fingerprint enrollment, it can assign max. time in sec until verification result comes. If a time is over the assigned time, fingerprint search stops without seeing verification result. This is specially designed for users who are waiting for longer search time against lower templates.
  - **Chk Fake FP**(Check Fake Fingerprint) :Enable or disable fake fingerprint detection feature.
- Input / Output
    - BioStation provides 2 respectively programmed input and output which can be connected to external device. In input/output menu, set input/output port.

**Input/Output**

Input 0	Disabled	Input 1	Disabled
Output 0	Disabled	Output 1	Tamper Switch
Tamper Switch	None	Duration(ms)	2000

- **Input0 & Input1** : Exit Switch, Wiegand(card), Wiegand(user), or Disabled.
- **Output0 & Output1** : Choose from duress, tamper switch, authentication success, authentication fail, wiegand(card), wiegand(user), and disabled. Signal output time of output port can be set in msec unit.
- **Tamper switch** : In case BioStation case is open, choose whether or not to set system lock mode for security reason.

● Relay

**Relay**

Driven By	All Events	Duration(sec)	3
Lock Time	None	Interphone	Disable
Unlock Time	None	<input type="button" value="Relay On"/> <input type="button" value="Relay Off"/>	

- **Driven By** : Choose from all events, auth + selected events, auth, selected events, and disabled. In case of selected events, user can set door open time.
- **Lock/Unlock Time** :Door lock time and unlock time can be set separately by day / holiday zone, which should be set in advance in time zone setting on access control menu.
- **Duration** : relay running time as per set event. Once door is released, door can be locked again after set door open time.
- **Interphone**: Enable this option when you are using a interphone along with BioStation.
- **Relay On / Off** : Administrator can control the relay of the BioStation by using this Relay On/Off menu.

Note : overall system door open time is computed by adding door lock open time and device open time.

### 5.5.6. Image & Sound

Menu to set background, sound effects and other display/sound of BioStation. User can set desired background, notice and log image and also change sound effect fit for user's style.

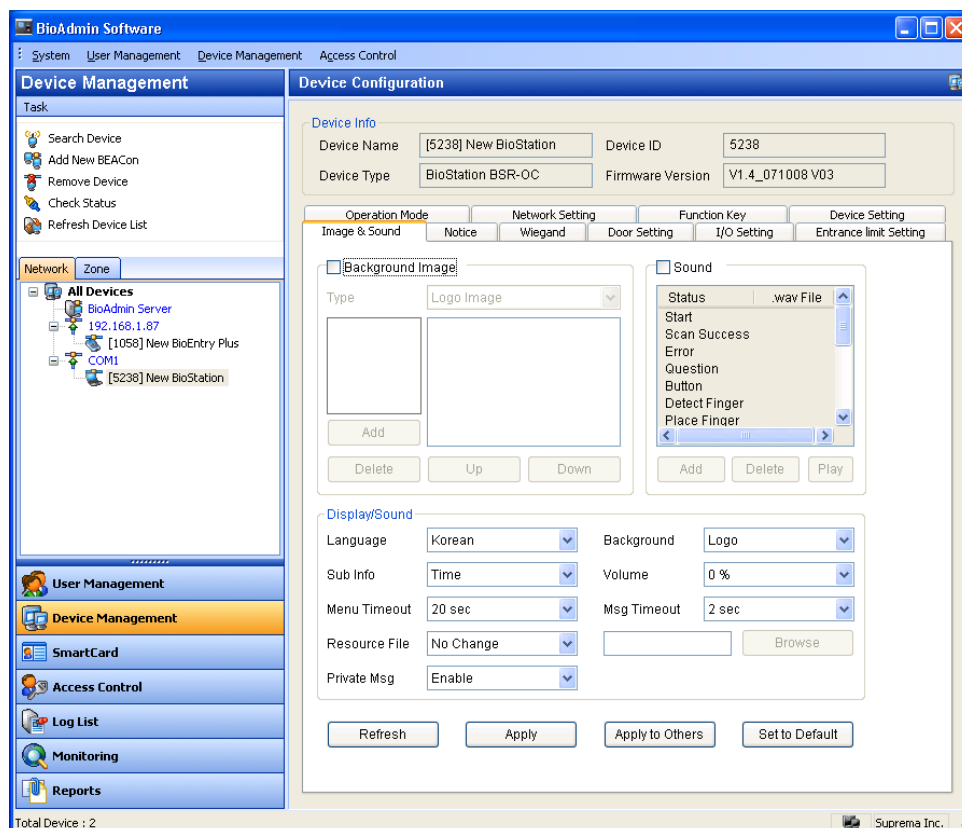

- Background Image

In this menu, user can change background image of BioStation. BioStation background can be chosen from logo image, slideshow, and notice. Image file format which can be uploaded to background are varying, i.e. JPG, GIF, BMP and PNG but size is fixed as 320\*240 pixels. In case the size of image file to upload is different, adjust image size using graphic tool.

In background, user can choose and upload one image file as background of logo image and notice. As for slideshow, maximum 16 image files can be uploaded and it shows images in turn at a set interval.

- Sound

In this menu, user can change sounds of device or check current sound effects. Sound effects of device consists of 6 sounds in total, i.e. start sound when

device is turned on, button sound when pressing a button, scan success sound when finger scan is successful, question sound when pressing a ESC button, error sound when finger scan failed, detect finger sound when a finger is placed on fingerprint sensor.

Note : the size of sound file can't exceed 512KB and sounds may not change depending on the format of the file.

- Display/Sound
  - **Language** : choose language used for menu and various messages on BioStation LCD display. Language can be chosen from Korean, English and Custom.
  - **Sub Info** : set items displayed at the lower part of BioStation background. Choose from notice, time, and none. In case of notice, contents are scrolled from right to left on display. Default is time
  - **Menu Timeout** : if no input is made in a certain menu for a set time, it returns to initial page. Choose from infinite, 10 sec, 20 sec, 30 sec. Default is 20 sec.
  - **Resource File** : choose from English, Korean, Custom, no change. Select language to change, click browse and choose applicable configuration file(\*.rc) after changing configuration file, reset BioStation to apply and select applicable language on language select menu to view.
  - **Private Msg** : Select private information such as photo or message displayed in BioStation LCD window.
  - **Background** : Choose from logo, notice and slideshow as background of BioStation LCD display.
  - **Volume** : to adjust speaker volume of BioStation. Volume ranges from 0 to 100%. When using daily in normal situation, set a volume as 20-50%. Default is **20%**.
  - **Msg Timeout** : When a user matches his fingerprint, BioStation shows the success or fail message on its screen. Administrator can change the time during which those messages are shown on the BioStation. Default is set as 2 seconds.

### 5.5.7. Notice

If there's company notice, administrator can show the notice on LCD of BioStation. Notice can be input up to maximum 1024 byte and a number of letters varies depending on language.

After transferring notice to device by pressing apply button, you can check and view notice on LCD of BioStation only if you selected notice as background in display/sound menu and apply.

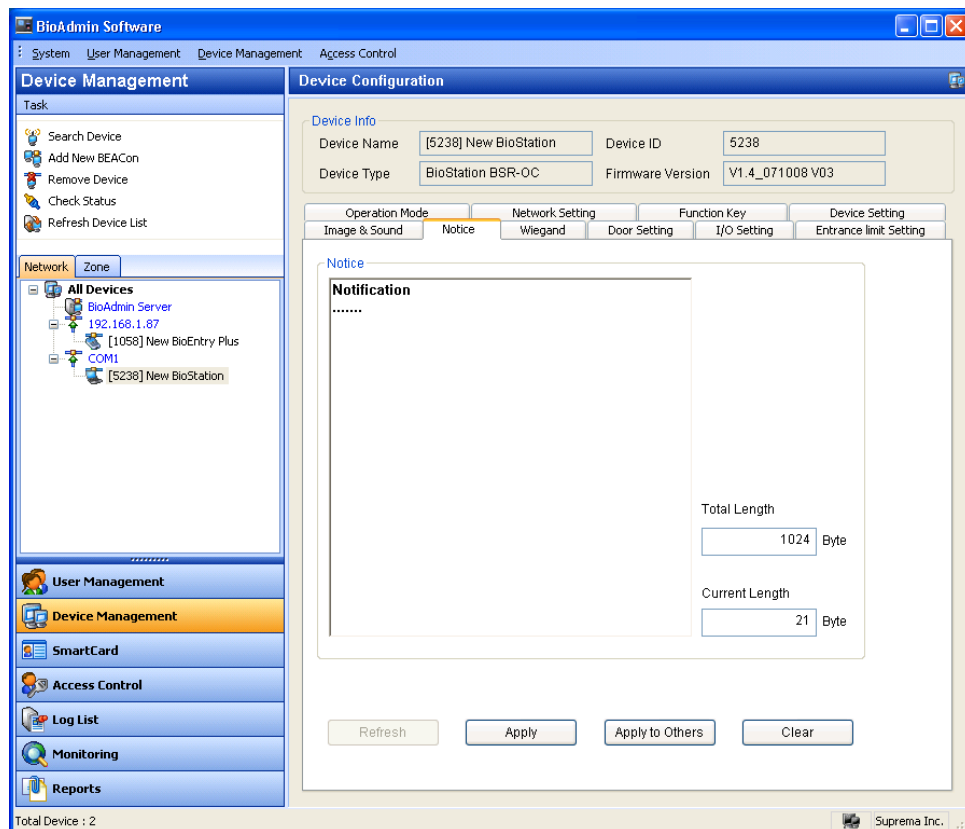

### 5.5.8. Wiegand

The **Wiegand Setting** tab is used to manage the Wiegand input/output format of BioStation. By selecting the menu, the Wiegand setting page is updated on the main window.

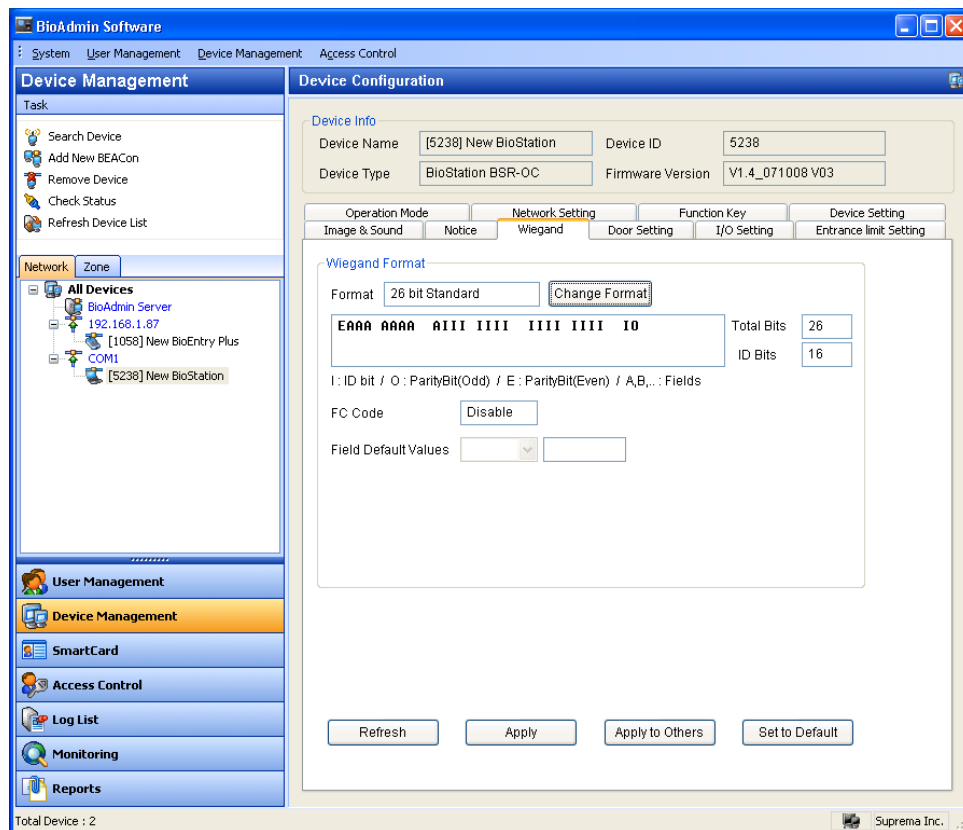

- **Wiegand Format**

New Wiegand format can be configured graphically using the Wiegand Configuration wizard. The Wiegand Configuration wizard will be shown by pressing the **Change format** button.

- **Select format**

You should select one of the three supported formats in the first page.

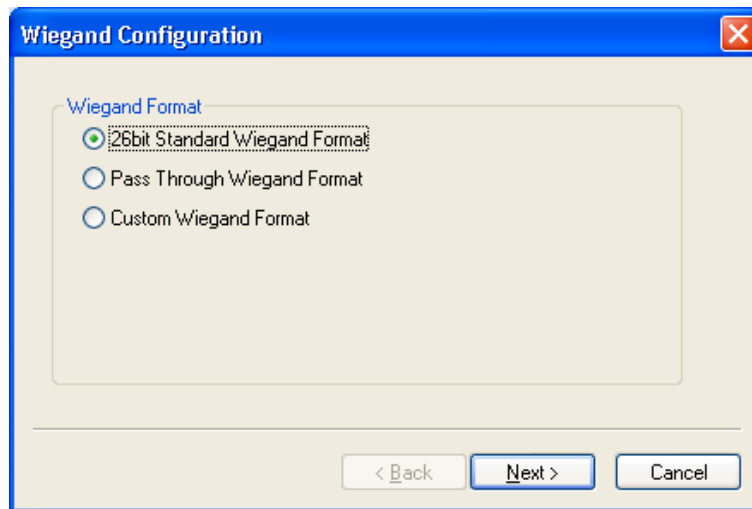

- 26 bit standard

The 26 bit standard format is most widely used and consists of 8 bit FC code and 16 bit ID. You cannot change the bit definition and the parity bits in 26 bit standard format.

- Pass Through format

Pass Through format is used when only the format of ID field is known. When the Wiegand input string is detected, BioEntry device extracts ID bits and starts verification with the ID. If the verification succeeds, the device outputs the Wiegand input string as unchanged. Parity check and advanced options are ignored in this format. By definition, Pass Through format is only useful when the operation mode is 1:1. If the mode is 1:N, the bits other than ID field are set to 0.

For example, assume that 32 bit Pass Through format is composed as follows:

XIIIIIIII IIIIIIX XXXIIIIII IIIIIIX (left most bit is 0th bit, BIT0)

I: Id field, X: Unknown field

You can configure this format in the following sequences.



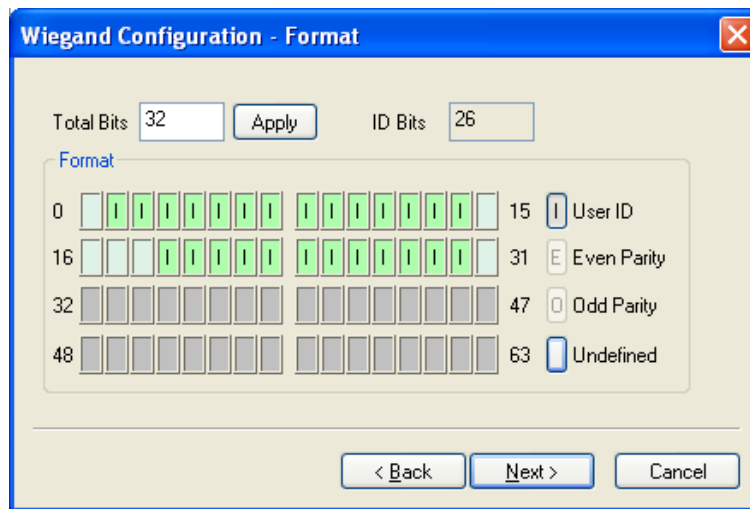

- (1) Enter 32 in the **Total Bits** field.
- (2) Select ID bits according to the definitions.
- (3) Press **Next**. You cannot specify parity bits in Pass Through mode.

- **Custom format**

When users know all the information of a Wiegand format, Custom format can be defined. When a Wiegand input string is detected, BioEntry device checks the parity bits first. If all the parity bits are correct, the device extracts ID bits and starts verification with the ID. Users can also set alternative values of each field and enable advanced options such as Fail ID. If the verification succeeds, the device outputs a Wiegand string. The output string may be different from the input string according to the alternative values and advanced options.

For example, assume that 44 bit Custom format is composed as follows:

EAAAAAAAA IIIIIIII IIIIIIII BBBBBI IIIIIIII IIIIO

(left most bit is 0th bit, BIT0)

E: Even parity for BIT1 ~ BIT22

O: Odd parity for BIT23 ~ BIT42

I: ID bits(Field1 and Field 3), A: Field 0, B: Field 2

You can configure this format in the following sequences.

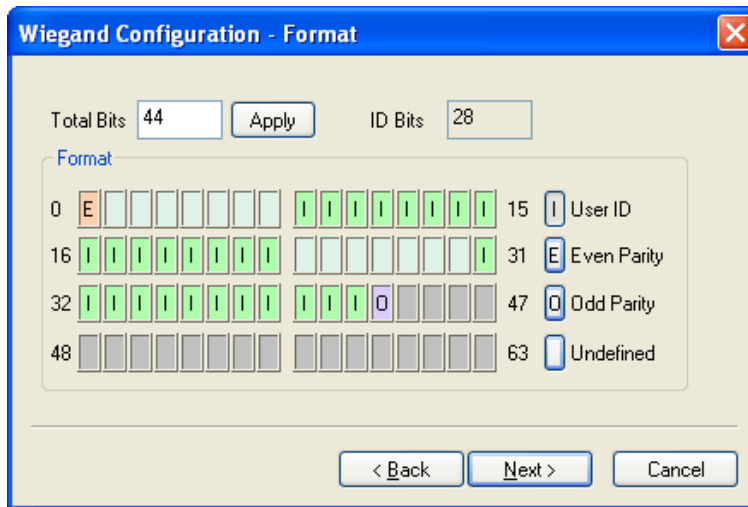

- Enter 44 in the **Total Bits** field.
- Select **Even Parity**.
- Press the even parity bit. In this example, it is BIT0.
- Select Odd Parity and press the odd parity bit and User ID according to the definition.
- Press **Next**.

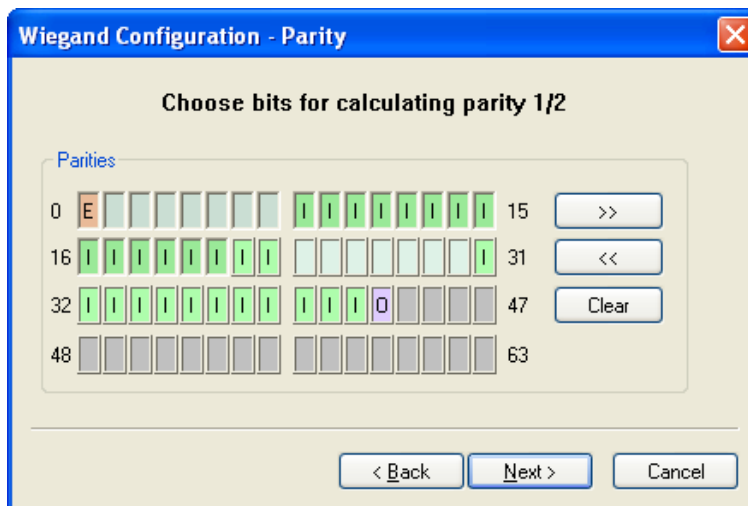

- Press the bits which are used in calculating the first parity bit. In this example, they are BIT1 ~ BIT22
- Press >>.
- Press the bits which are used in calculating the second parity bit. In this example, they are BIT23~ BIT42.
- Press **Next**.

- Alternative values

In 26 bit standard you can specify alternative FC code. In Custom format, you can specify alternative values for non-ID field. If alternative values are set, the BioEntry™ device will replace corresponding fields with these values before sending outputs.

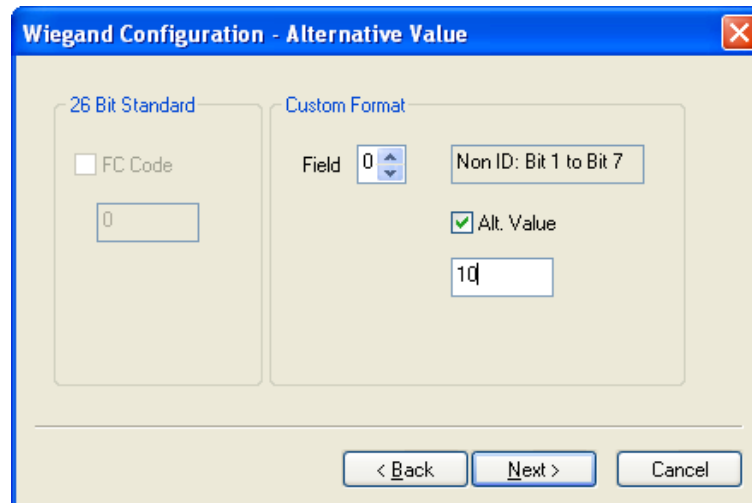

### 5.5.9. Door Setting

The details setting of door that is operated by each device may be set up. Two doors may be controlled by one device and Secure I/O door connected by RS485 may be also controlled.

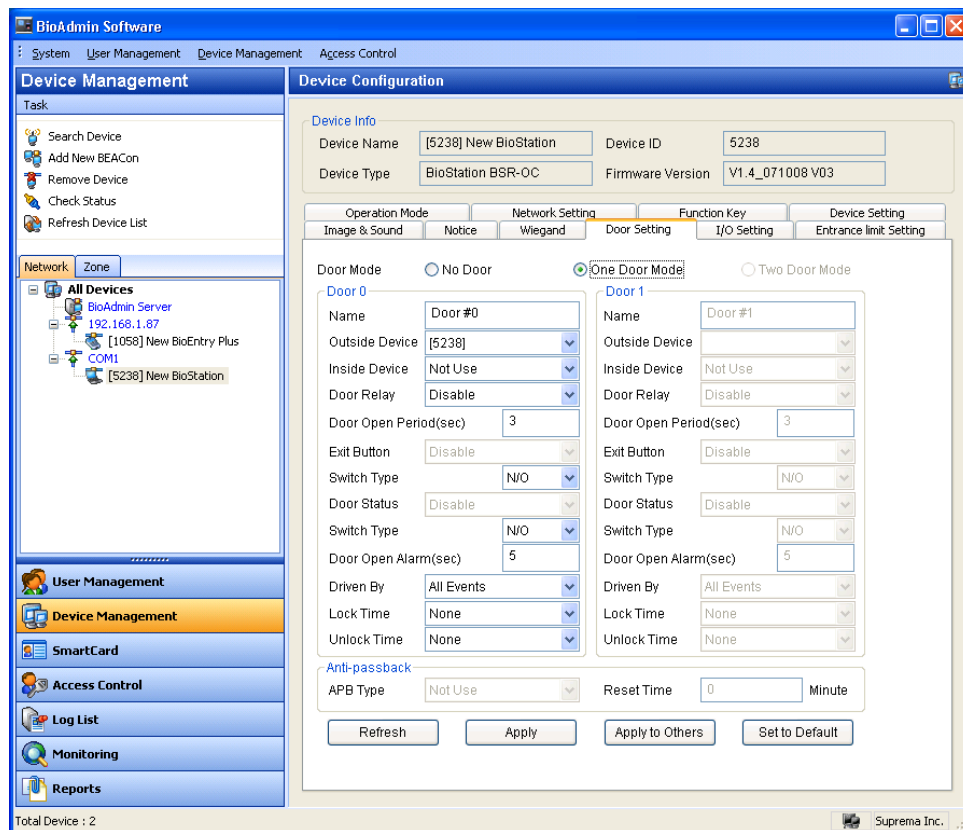

- **Outside / Inside Device** : Set two devices to control 1 door.
- **Door Open Relay** : Set the output terminal to control door among the connected devices.
- **Door Open Period (sec)** : Set the time when the selected output terminal operates in door open relay.
- **Exit Button** : Select a button input terminal used to open door.
- **Door Status** : Select an input terminal to connect a sensor used to check the status of door.
- **Switch Type** : N/O or N/C
- **Door Open Alarm (sec)** : Enter the time to determine whether door is open for a long time.
- **Driven By** : Select an event when door is open for a time longer than the set 'Door Open Alarm' setting.
- **Lock Time** : Set the time when a designated door is always closed, as an item inter-working with the entrance/exit time set in entrance control item.
- **Unlock Time** : Set the time when a designated door is always opened, as an

item inter-working with the entrance/exit time set in entrance control item.

- **Anti-passback** : Set whether to apply anti-passback between Outside and Inside device.
  - Soft : Make a record and allow entrance in case of not verifying APB.
  - Hard : Not allow record and entrance in case of not verifying APB.
  - Reset Time : Make clearing entrance limit time against APB limit.

### 5.5.10. I/O Setting

Make operation of each input and output setting possible through I/O setting.

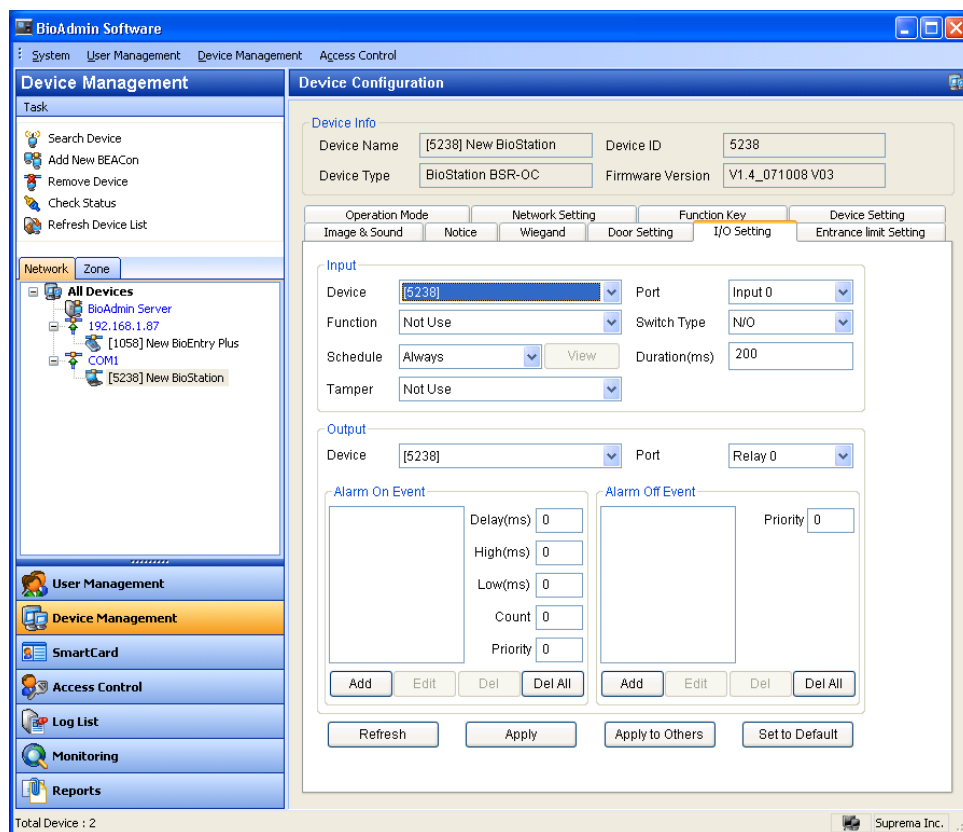

- Input

**Input**

Device	[5238]	Port	Input 0
Function	Not Use	Switch Type	N/O
Schedule	Always	Duration(ms)	200
Tamper	Not Use		

View

- **Device Type** : Display the device to be set at present.
- **Function** : Select a function to be performed as an input. Default : Not use
- **Schedule** : Set the input to be operated only for the time set in access control (Always or No Time)
- **Tamper** : Set to designate the function of tamper.
- **Port** : Select one of input terminals set in the selected device.
- **Switch Type** : N/O or N/C
- **Duration(ms)** : Operate as long as the longer time is entered

● Output

**Output**

Device	[5238]	Port	Relay 0
--------	--------	------	---------

**Alarm On Event**

Delay(ms)	0
High(ms)	0
Low(ms)	0
Count	0
Priority	0

Add Edit Del Del All

**Alarm Off Event**

Priority	0
----------	---

Add Edit Del Del All

- **Device type** : Display the devices to be set at present.
- **Port** : Select an output terminal to be set in a selected device.
- **Alarm On Event** : It may set so that if a listed event occurs, the output is generated from the port of a selected device.

● How to add Event

- **Event** : It is set so that if a selected event occurs, the output is generated to the port of the previously selected device.
- **Device** : Select a device to generate an event.
- **Priority** : By allowing priority to a function, it may prevent a priority event from being hidden or turned off, preceding over low priority function.
- **Signal Setting**
  - Delay: delay time before output is generated
  - Count: frequency to repeat off ~ on interval
  - High: time when output is generated
  - Low: time when output is not generated
- **Alarm Off Event**

If a listed event occurs, it may release an output of which priority is equal to or lower than the priority of the port of a selected device.

#### 5.5.11. Entrance Limit Setting

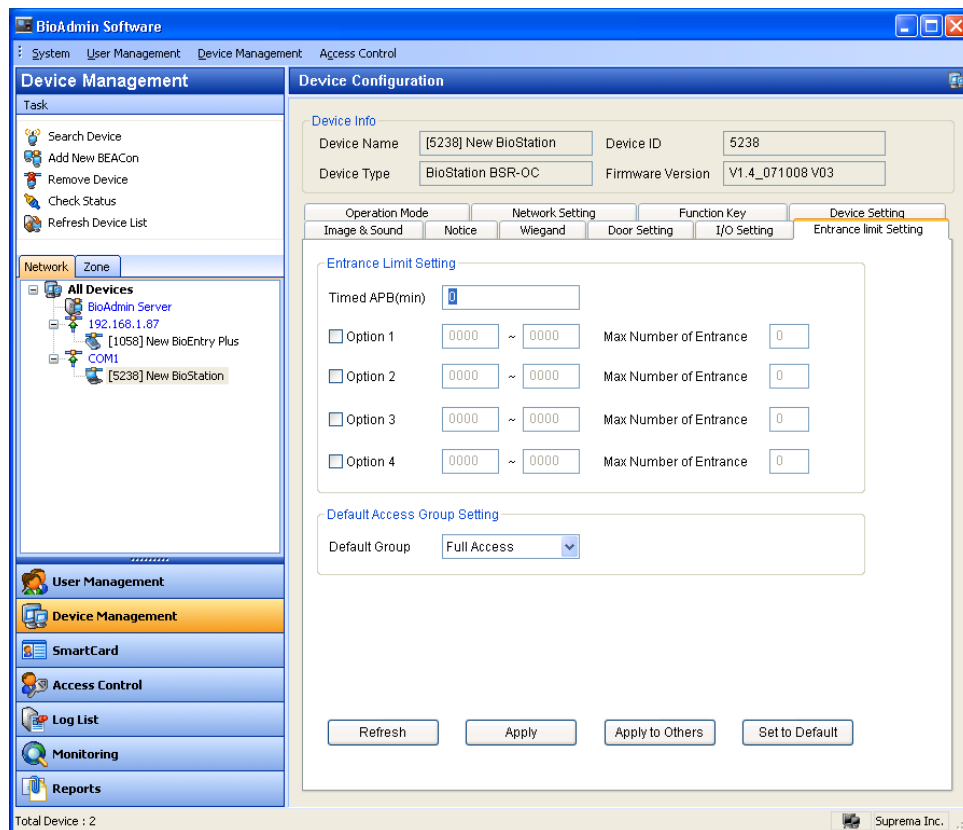

- Entrance Limit Setting may be set to restrict repetitive verification or prevent repetitive entry for a specified time.
  - **Timed APB** : Limit verification if re-verification is not attempted for a specified time (minute).
  - **Options 1~4** : If entering start time ~ end time of each option and specifying the Max Number of Entrance for the time, it allows the only number of access for the specified time.
- Default Access Group Setting
 

In case of a user with no access group information, it may set a user to be grouped in an access group. The default is Full Access, which allow users who does not assign access group.

## 5.5.12. Black List



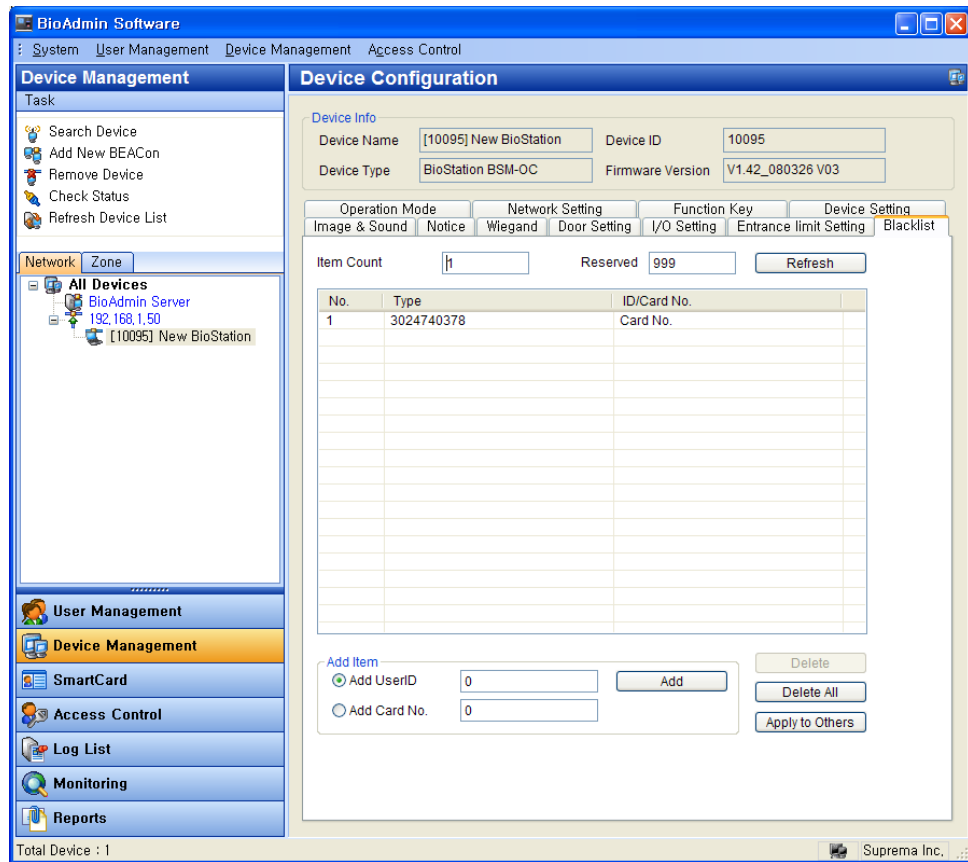

Manage the separate list to deny verification. If receiving verification request for Card S/N or User ID registered on the black list, the device denies verification and leaves failed log. The maximum number of black list is 1,000.

Item Count: The current registered number of list

Reserved: Available number of list to register

Refresh: Read a list from the device

- **Add Black List** :Check User ID or Card No, determine the item to block, type number, and click 'Add'. In case of already registered or adding more than 1,000, it cannot be registered.
- **Delete Black List** :Click the item to delete from a list and click 'Delete' button.
- **Delete All** :Delete all registered Black list.
- **Apply to Others** :Apply the current black list to other devices.

## 5.6. Manage Virtual Terminal

You can manage a virtual terminal with the same device management menus for BioStation, except the followings.

- **Time Setting** : You cannot set the time of BioStation with virtual terminal. Thus, you should set time directly to BioStation.
- **Lock all devices / Unlock all devices** : You cannot set lock/unlock of BioStation with virtual terminal. Thus, you should the lock/unlock directly to BioStation.
- **Firmware Upgrade** : Store a firmware file on a virtual terminal. Connect the virtual terminal to BioStation and upgrade the firmware using firmware upgrade menu on BioStation.

After connecting a virtual terminal to BioStation, you can use the following menus of BioStation. For the detailed operation, refer to the BioStation User Guide.

- **Synchronize** : Change the user data and device settings of BioStation as same as the stored data on virtual terminal .
- **Export Virtual Terminal** : Remove the stored data on virtual terminal and make a new virtual terminal with the current data of the BioStation.
- **Import Virtual Terminal** : Remove the stored data on BioStation and apply the data store on virtual terminal.
- **Firmware Upgrade** : Upgrade the BioStation firmware with the stored firmware file on virtual terminal.
- **Initialize** : Remove all virtual terminals on from USB memory.
- **Refresh** : Check the status of the USB memory and activate menus regarding USB memory.

## 5.7. Manage BioEntry Plus device

### 5.7.1. Device information

- It shows the device name, device type, device ID and firmware version of the selected BioEntry Plus. Device ID number and firmware version are necessary information to check the product for our technical support after the installation.

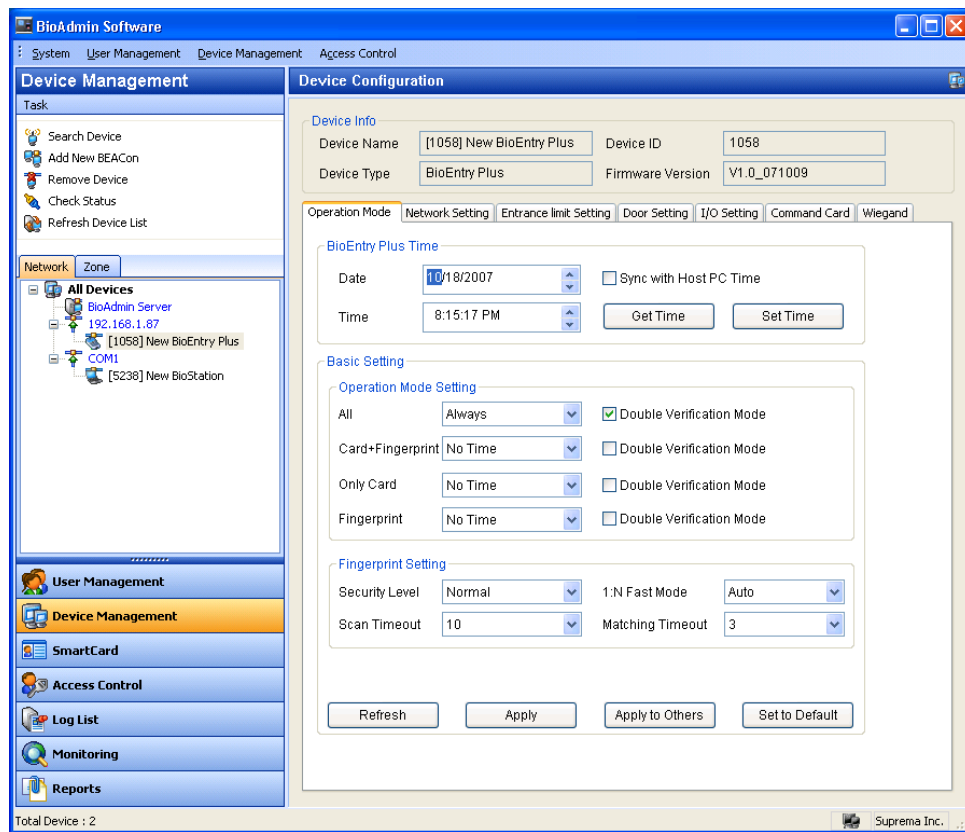

### 5.7.2. Detect Device via UDP

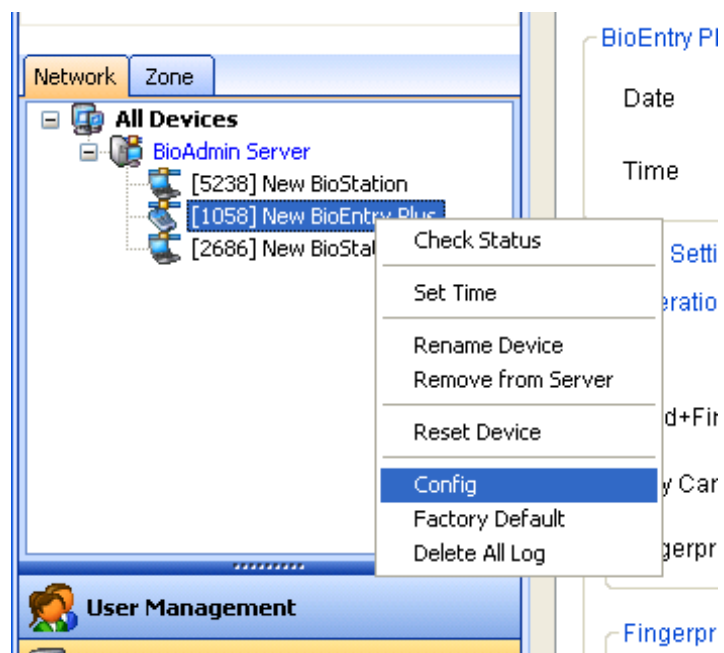

- 'Config' menu may be selected by clicking right mouse button on BioEntry Plus icon or a name.

BioEntry Plus Network Setting

192.168.1.87(1058)

**System Information**

ID: 1058

MAC: 00:17:fc:20:04:22

**Network Setting**

Use DHCP

Use Server

Time Sync with Server

IP Address: 0 . 0 . 0 . 0

Gateway: 0 . 0 . 0 . 0

Subnet Mask: 0 . 0 . 0 . 0

Server IP: 192 . 168 . 1 . 120

Port: 1480

- **System Information** : Show the ID and MAC address assigned to BioEntry Plus at present; if clicking Refresh button, it reads the information again.
- **Network Setting**
  - **Use DHCP**
    - Check it if the BioEntry Plus is to be automatically assigned with IP
  - **Use Server**
    - Check it if BioEntry Plus is connected to BioAdmin Server and operates.
    - Check it to synchronize temporary with server
  - **Port**
    - Use the same value with the BioEntry Plus port and the server port.

### 5.7.3. Operation Mode

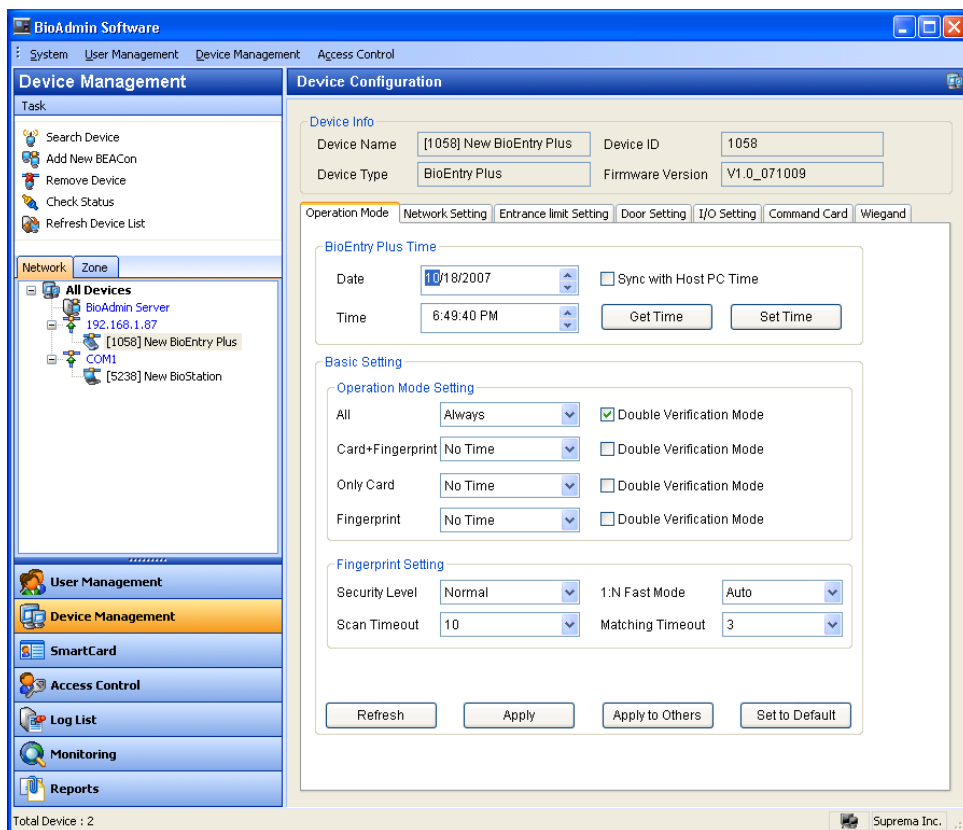

- BioEntry Plus Time

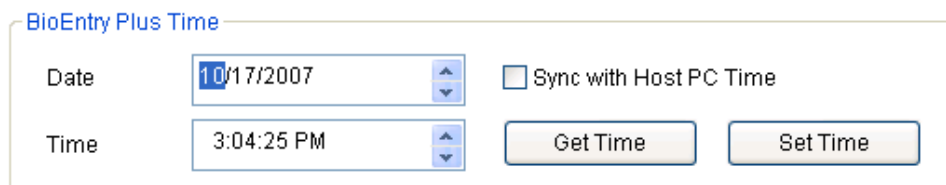

- Date & Time : Read from BioEntry Plus device.
- “Get Time” button makes BioAdmin read from BioEntry Plus.

- There are two methods to read a date & time shown as below.
  - Manual Type : Just type date & time manually and pressing 'Set Time' button makes them transfer to BioEntry Plus device.
  - 'Synchronize with Host PC Time' : Check it and press 'Set Time' button to transfer to BioEntry Plus device.

#### ● Operation Mode Setting

Operation Mode Setting

All	Always	<input checked="" type="checkbox"/> Double Verification Mode
Card+Fingerprint	No Time	<input type="checkbox"/> Double Verification Mode
Only Card	No Time	<input type="checkbox"/> Double Verification Mode
Fingerprint	No Time	<input type="checkbox"/> Double Verification Mode

- BioEntry Plus has 4 operation mode setting options from No.1 to No. 4. each option may be assigned for its time.
- Double Verification Mode: Door is operated as long as different user verifications should be executed within 15 seconds.

Note : Double Verification mode is specially designed for two user's verification for secure access control.

#### ● Fingerprint Setting

Fingerprint Setting

Security Level	Normal	1:N Fast Mode	Auto
Scan Timeout	10	Matching Timeout	3

- Security Level : Normal, Secure, More Secure  
Control FAR (False Acceptance Rate) internally. The more FAR, the less FRR (False Rejection Rate), so default is normal level.
- 1:N Fast Mode : Auto, Normal, Fast, Faster

In case more than hundreds fingerprints are saved in device, 1:N mode may take longer. If you set fast mode as fast or fastest, performance is somewhat low but 1:N recognition can take less time. Default is normal.

- Scan Timeout : 1~20 sec

User can designate the standby time when entering fingerprint. If a user doesn't enter fingerprint within this time, it is construed as input failure. Default is 10 sec.

- Matching Timeout : 0~10 sec

After fingerprint enrollment, it can assign max. time in sec until verification result comes. If a time is over the assigned time, fingerprint search stops without seeing verification result. This is specially designed for users who are waiting for longer search time against lower templates.

- Template Option Information

#### Template Option Informations

ISO Format

- ISO Format

Display BioEntry Plus uses ISO 19474-2 Template Format Data. In case of 'On', it cannot use Suprema format template.

- Check Fake Finger

Examine fake fingerprint of the enrolled fingerprint when trying verification. Since it is designed to deny against fake fingerprint and it might deny normal fingerprint, you may feel lower verification rate.

- Mifare Setting

In case of BioEntry Plus Mifare model, Mifare Setting option will be appeared.

#### Mifare Setting

Disable Mifare Card

Use Template On Card

[View Card Layout](#)

- Disable Mifare Card

Disable Mifare card, and not to accept card input.

- Use Template On Card

Configure whether it uses template on card or Card ID such as RF-card type by storing template information on the Mifare card.

- View Card Layout



Verify Mifare Layout information of BioEntry Plus, which can be referred at “6. Smartcard / Mifare card”.

#### 5.7.4. Network Setting

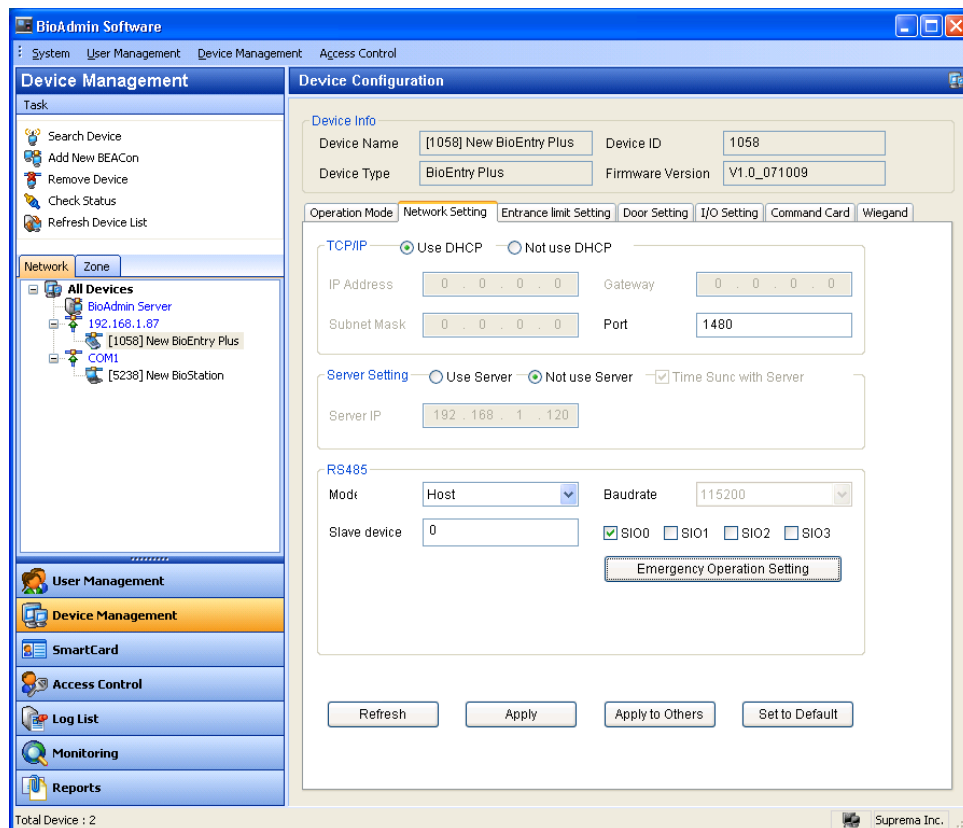

- TCP/IP
  - It selects whether to receive IP address automatically from the settings of BioEntry Plus or be manually set. If the IP address is set as DHCP to BioEntry Plus or if directly setting 'Use DHCP', select 'Not use DHCP'.
  - Set the IP address, gateway, subnet mask, and port as proper values.
  - Port (default: 1471) is operated as a server port if it uses server.
- Server Setting
  - It shows whether the BioEntry Plus is connected to server
  - If connecting BioEntry Plus that is connected to general TCP/IP, not a server, to server, check 'Use' and set the server IP address and the server port.

- As such, if connected to a server, the BioEntry Plus is connected to it and disconnected from the TCP/IP immediately. It may take a time until it is reconnected to the server again.
- If the communication status of BioEntry Plus connected to the server is not good, click the right mouse button on BioAdmin Server and try to reconnect to server.
- RS485  
Use for RS-485 communication of BioStation. In RS-485 mode, the connected devices take a role as 'Host' and 'Slave'. Suprema's new total integrated system including BioStation, BioEntry Plus, and Secure I/O consist of 1 host device, 1 slave device, and max. 4 Secure I/O. Host device has total 10 relay and 20 input. Please refer to the "Secure I/O Installation Guide" and "4.5.3 Network Setting" of BioStation in this manual for further information.
  - Mode : PC Connection, Host, Slave, None
  - Baudrate
  - Slave Device
  - SIO default Setting

The screenshot shows a dialog box titled "Emergency Operation Setting". It features a "Device" dropdown menu currently set to "Secure I/O #0". Below this, there are two main sections: "Input" and "Output". The "Input" section includes a "Port" dropdown set to "Input #0", a "Switch Type" dropdown set to "N/O", and a "Duration(ms)" text box containing "0". The "Output" section includes a "Port" dropdown set to "Output #0", a "High(ms)" text box containing "0", a "Low(ms)" text box containing "0", and a "Count" text box containing "0". At the bottom of the dialog are "Save" and "Cancel" buttons.

### 5.7.5. Entrance Limit Setting

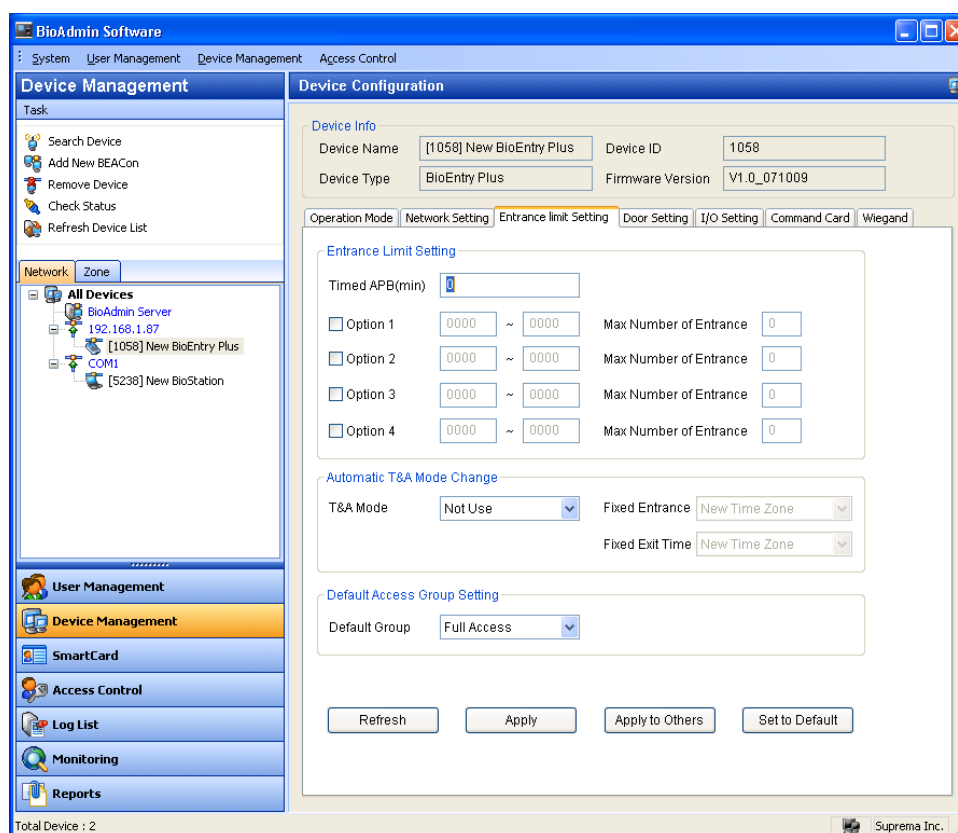

- Entrance Limit Setting

- Timed APB : Limit verification if re-verification is not attempted for a specified time (minute).
- Options 1~4 : If entering start time ~ end time of each option and specifying the max. access allowance number for the time, it allows the only number of access for the specified time.

- Automatic T&A Mode Change

- Set in which attendance mode BioEntry Plus is used.
- T&A mode : Not use, Fixed in, Fixed out, Auto
  - Auto Mode: if authentication is approved for a specified time, its attendance mode is automatically converted to Entrance or Exit.
  - Fixed in / Fixed out mode: Set the attendance mode to either entry or exit among entrance or exit.

- Default Access Group Setting

In case of a user with no access group information, it may set a user to be

grouped in an access group.

### 5.7.6. Door Setting

- The detail setting of door that is operated by each device may be set up.

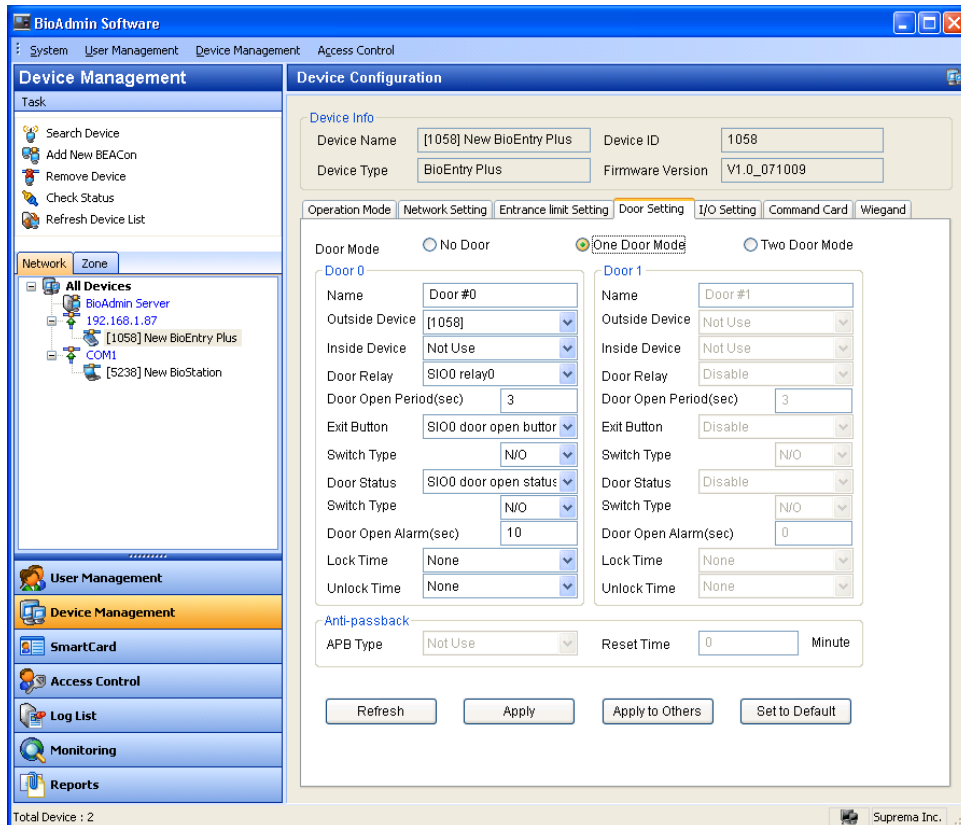

- Outside / Inside Device : Set two devices to control 1 door.
- Door Relay : Set the output terminal to control door among the connected devices.
- Door Open Period (sec) : Set the time when the selected output terminal operates in door open relay.
- Exit Button : Select a button input terminal used to open entrance door, which is Input 0 for use (N/O : Normal Open , N/C : Normal Close).
- Door Status : Select an input terminal to connect a sensor used to check the status of entrance door (N/O or N/C), which is Input 1 for use.
- Door Open Alarm (sec) : Enter the time to determine whether entrance door is open for a long time.

- Driven By : Select an event when an entrance door is open for a time longer than the set 'Long Time Door Open' setting.
- Lock Time : Set the time when a designated entrance door is always closed, as an item inter-working with the entrance/exit time set in entrance control item.
- Unlock Time : Set the time when a designated entrance door is always opened, as an item inter-working with the entrance/exit time set in entrance control item.
- Anti-passback : Set whether to apply anti-passback between Outside and Inside device.
  - Soft : Make a record and allow entrance in case of not verifying APB.
  - Hard : Not allow record and entrance in case of not verifying APB.
  - Reset Time : Make clearing entrance limit time against APB limit.

### 5.7.7. I/O Setting

- Window to set I/O terminals as use's discretion, besides door.

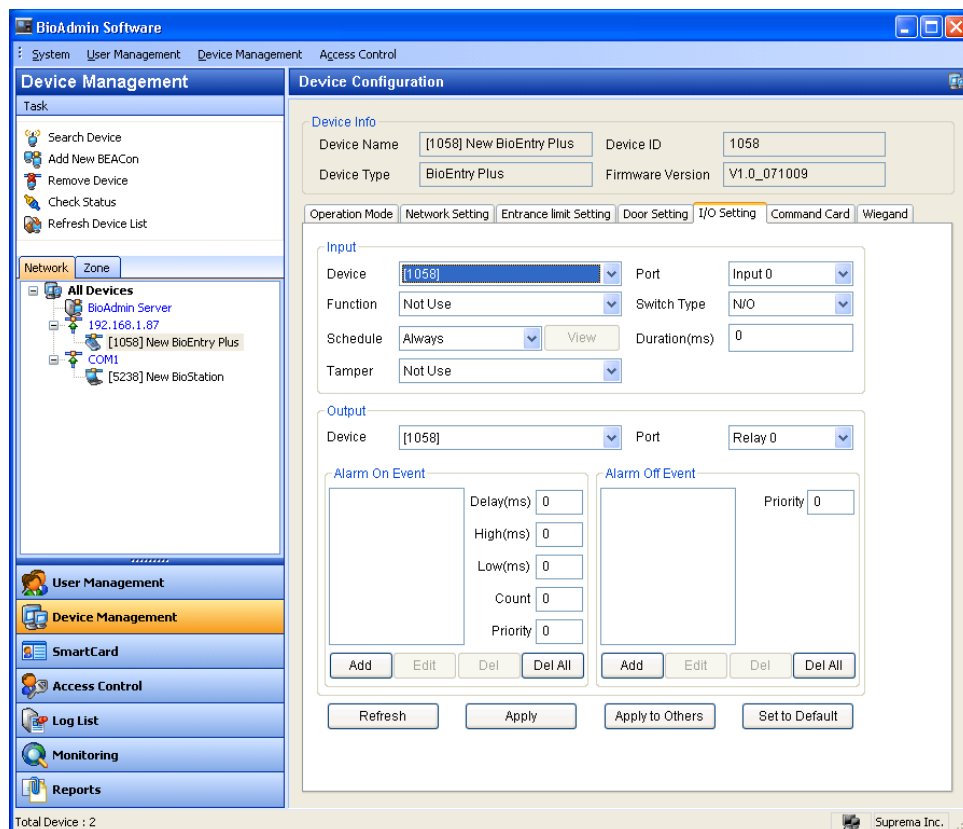

- Input

**Input**

Device	[1058]	Port	Input 0
Function	Not Use	Switch Type	N/O
Schedule	Always	Duration(ms)	0
Tamper	Not Use		

View

- **Device Type** : Display the device to be set at present.
- **Function** : Select a function to be performed as an input.
- **Schedule** : Set the input to be operated only for the time set in access control
- **Tamper** : Set to designate the function of tamper.
- **Port** : Select an input terminal set in the selected device.
- **Switch Type** : N/O or N/C
- **Duration(ms)** : Operate as long as the longer time is entered

● Output

**Output**

Device	[1058]	Port	Relay 0
--------	--------	------	---------

**Alarm On Event**

Delay(ms)	0
High(ms)	0
Low(ms)	0
Count	0
Priority	0

Add Edit Del Del All

**Alarm Off Event**

Priority	0
----------	---

Add Edit Del Del All

- **Device** : Display the devices to be set at present.
- **Port** : Select an output terminal to be set in a selected device.
- **Alarm On Event** : It may set so that if a listed event occurs, the output is generated from the port of a selected device.

● How to add Event

- **Event** : It is set so that if a selected event occurs, the output is generated to the port of the previously selected device.
- **Device** : Select a device to generate an event.
- **Priority** : By allowing priority to a function, it may prevent a priority event from being hidden or turned off, preceding over low priority function.
- **Signal Setting**
  - Delay: delay time before output is generated
  - Count: frequency to repeat off ~ on interval
  - High: time when output is generated
  - Low: Time when output is not generated
- **Alarm Off Event**

If a listed event occurs, it may release an output of which priority is equal to or lower than the priority of the port of a selected device.

### 5.7.8. Command Card

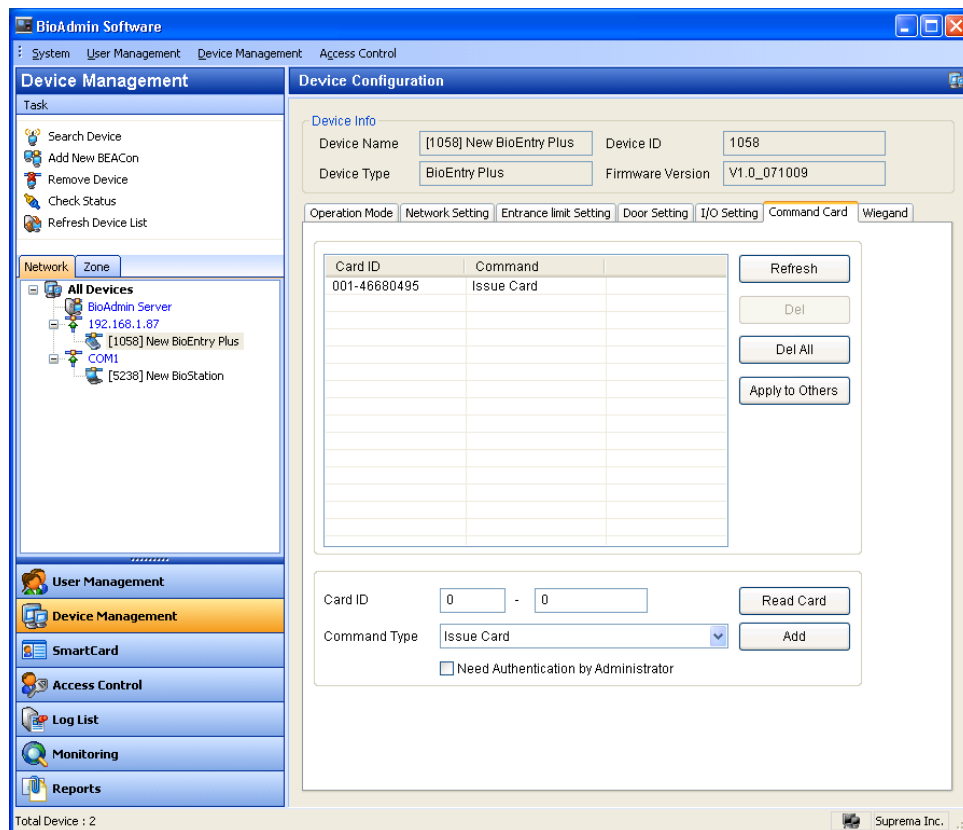

- Command Card has outstanding feature provided by BioEntry Plus, which easily add or delete new user, or delete all user using BioEntry Plus device.
- Card List: Display the list of command card registered to the currently selected BioEntry Plus.
- Card ID : Display the card number read from a card or input the ID of RF card to register
- Read Card : Read the ID of RF card to register and display card ID item.
- Command type : Select a function to give the RF card to input
- Need Authentication by Administrator : As it requires a user for admin authentication, it may prevent misuse or abuse.

### 5.7.9. Wiegand

- Wiegand tab is used to manage the Wiegand I/O format. If selecting the menu, Wiegand setting page is updated on the window.



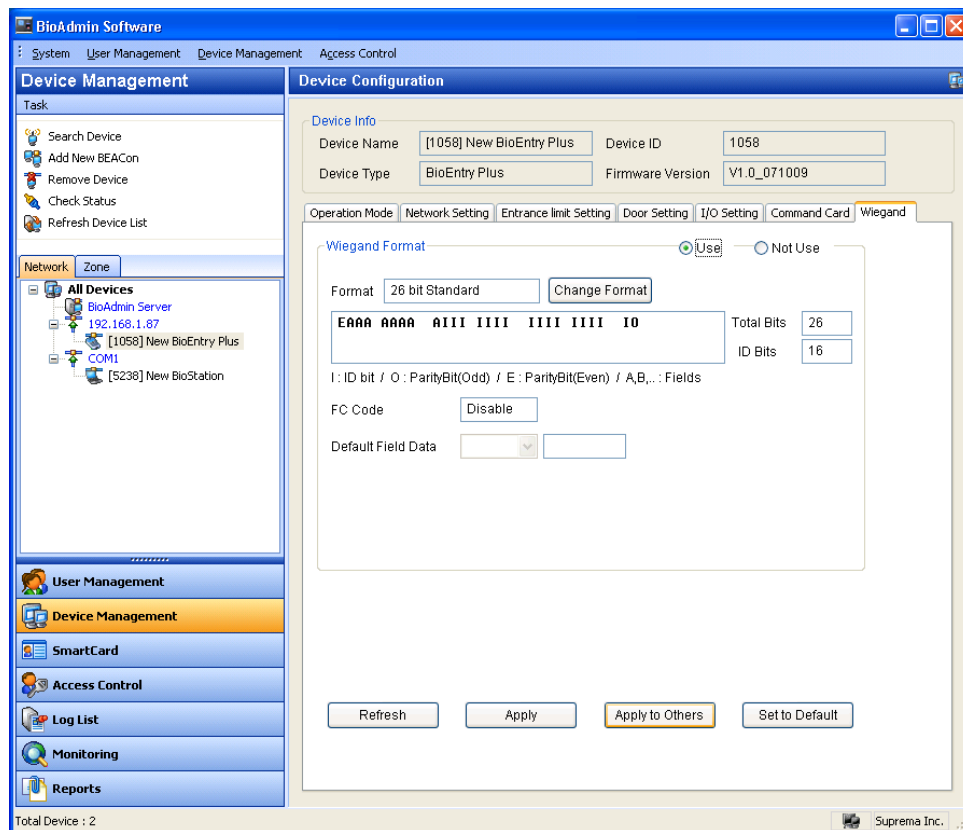

- Wiegand format

It is possible to set new Wiegand format by using Wiegand setting wizard. Pressing Format change shows the Wiegand Setting wizard.

Select one of three formats supported in the first page.

- 26 bit standard Wiegand format

26 bit standard format is the most widely used and consist of 8 bits FC code and 16 bits ID. In 26 bits standards formation, bit definition and parity bit may not be changed.

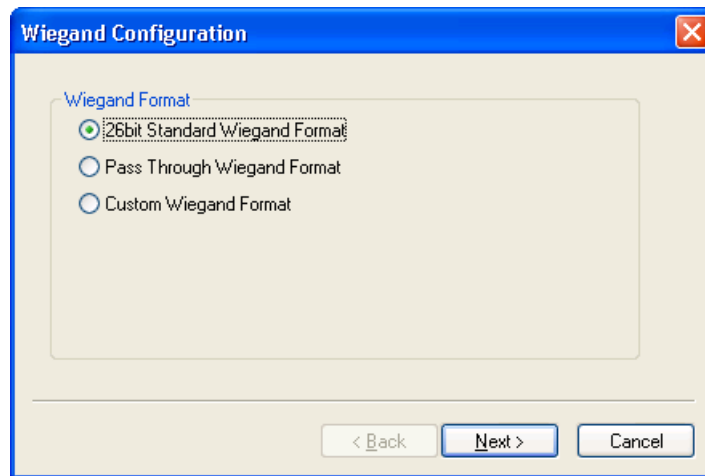

- **Pass Through Wiegand Format**

Pass Through Format is used as long as ID field format is known. If Wiegand input string is detected, the device finds ID bits and starts the authentication with the ID. If authentication is successful, the device outputs the Wiegand input string with no change. Parity check and advanced options are disregarded in the format. According to the definition, Pass Through format is available only when the use mode is 1:1. In case of use mode is 1:N, bit order except ID field should be set to 0. Assuming that 32 bit Pass Through format is as follows.:

XIIIIII IIIIIIX XXXIIII IIIIIIX

(the very left bit is 0th bit, BIT0) I: Id field, X: Unknown field

The format can be set as the following sequence.

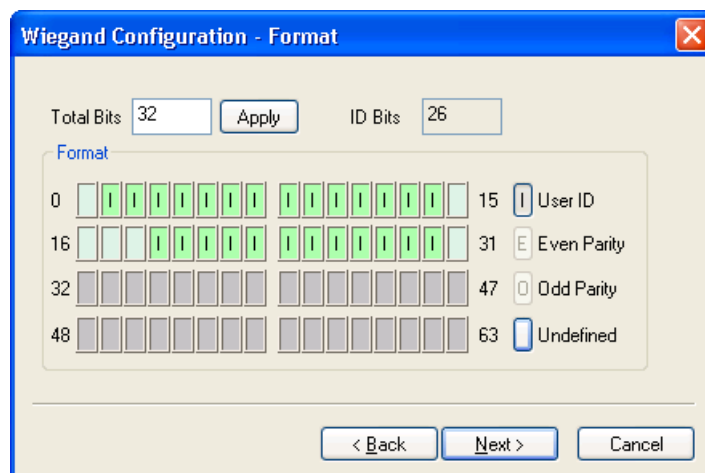

- Input 32 into Total Bits field.
- Select a ID bit according to the definition.
- Press Next button. In pass through mode, parity bit may not be specified.
- User-defined Wiegand format

If a user has the overall information for Wiegand format, the user may set the customized format. If Wiegand input string is detected, the device checks the parity bit first of ally. If every parity bit is correct, the device extracts ID bit and starts the authentication with the ID. A user may set each field with other values and set advanced option such as Fail ID. If authentication is successful, the output strings may differ from input string, depending on replaced values and advanced options.

Assuming that 44 bit customized format is structured as follows:

EAAAAAAAA IIIIIIII IIIIIIII BBBBBI IIIIIIII IIIIO

- (the very left bit is 0th bit, BIT0)
- E: Even parity for BIT1 ~ BIT22
- O: Odd parity for BIT23 ~ BIT42
- I: ID bits(Field1 and Field 3), A: Field 0, B: Field 2

The format may be set as the following sequence.

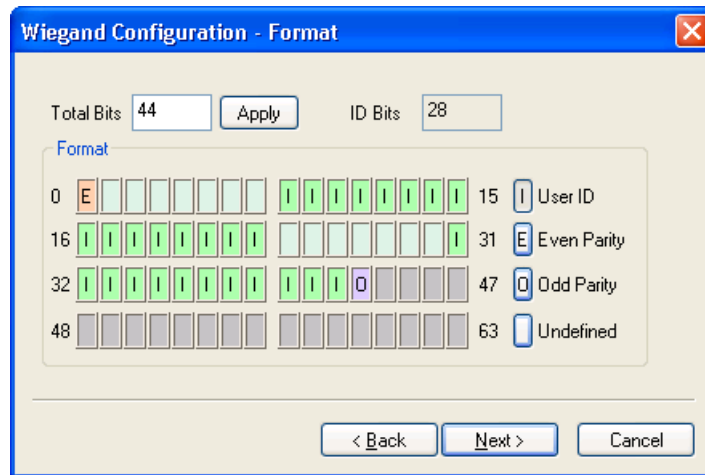

- Enter 44 into Total Bits field.
- Select Even Parity.
- Press 'even parity bit'. In the example, it means BIT0.
- According to the definition, repeat (2) and (3) for Odd Parity and User ID.
- Press Next button.

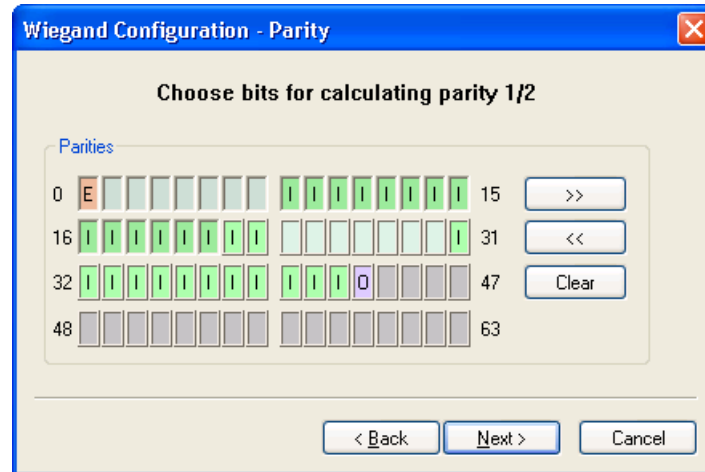

- Press the buttons used to calculate the first parity bit. In the example, they are BIT1 ~ BIT22.
  - Press >> button.
  - Press the buttons used to calculate the second parity bit. In the example, they are BIT23~ BIT42.
  - Press Next button.
- Replaced value
 

In 26 bit standard, it is possible to specify another FC code. In customized format, it is possible to specify the replaced value in non-ID field. If the replaced value is set, the device change the fields with the replaced values.

#### 5.7.10. Black List

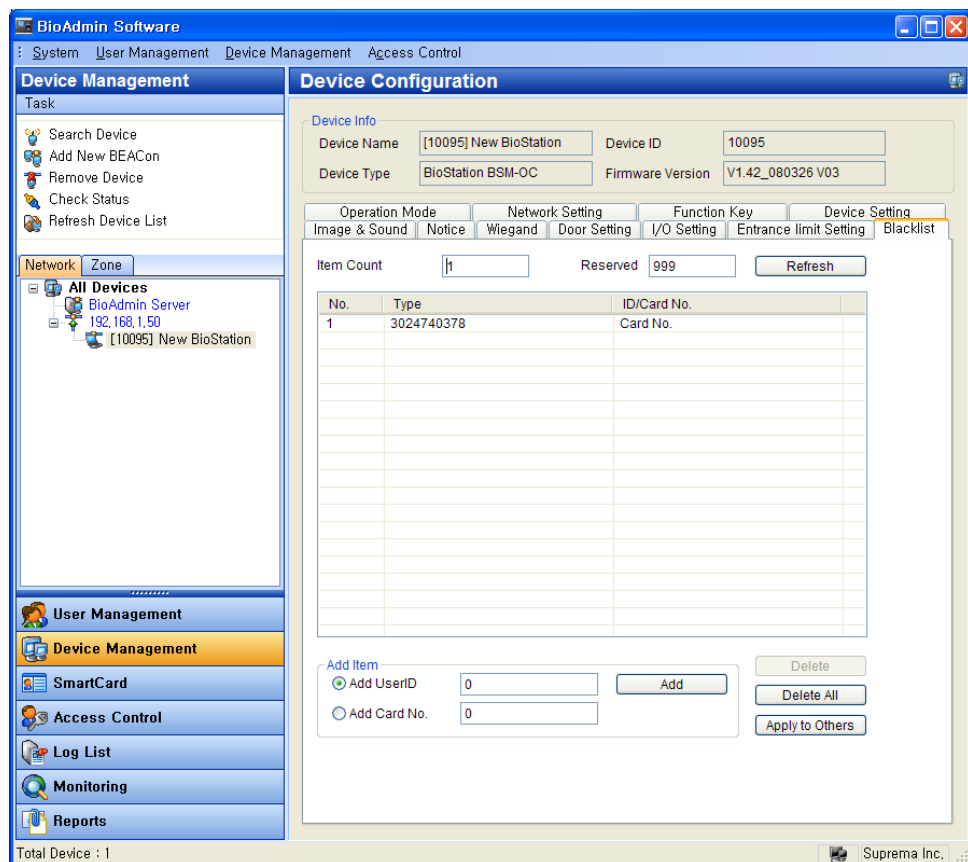

Manage the separate list to deny verification. If receiving verification request for Card S/N or User ID registered on the black list, the device denies verification and leaves failed log. The maximum number of black list is 1,000.

Item Count: The current registered number of list

Reserved: Available number of list to register

Refresh: Read a list from the device

- **Add Black List** : Check User ID or Card No, determine the item to block, type number, and click 'Add'. In case of already registered or adding more than 1,000, it cannot be registered.
- **Delete Black List** : Click the item to delete from a list and click 'Delete' button.
- **Delete All** : Delete all registered Black list.
- **Apply to Others** : Apply the current black list to other devices.

## 5.8. Manage BioLite Net device

### 5.8.1. Device information

- It shows the device name, device type, device ID and firmware version of the selected BioEntry Plus. Device ID number and firmware version are necessary information to check the product for our technical support after the installation.

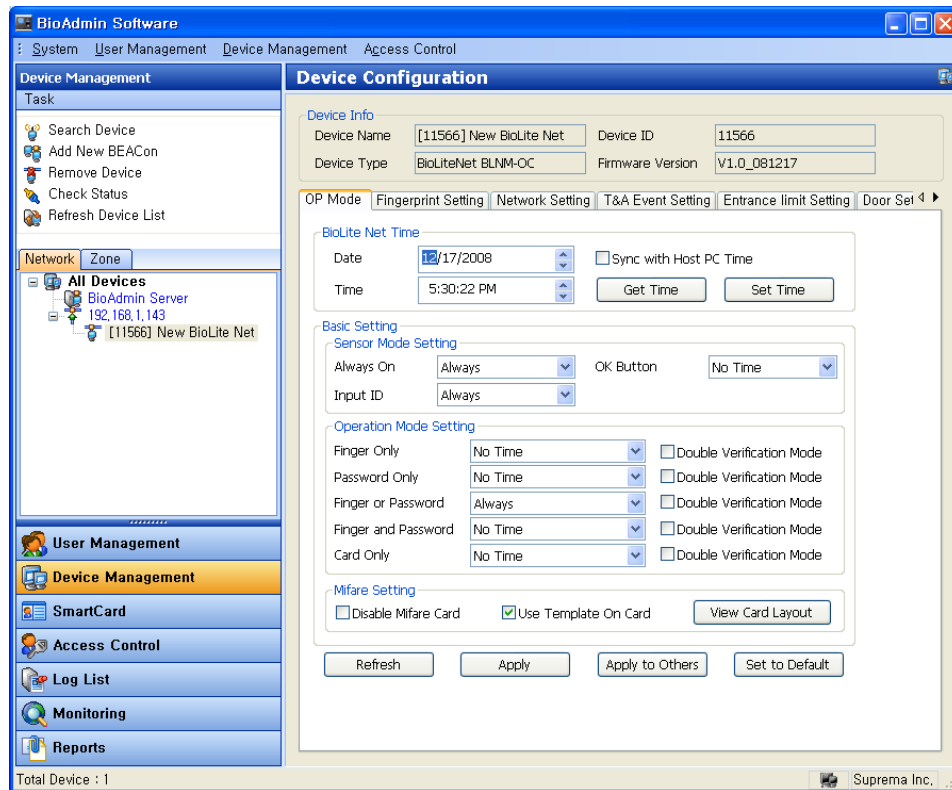

### 5.8.2. Detect Device via UDP

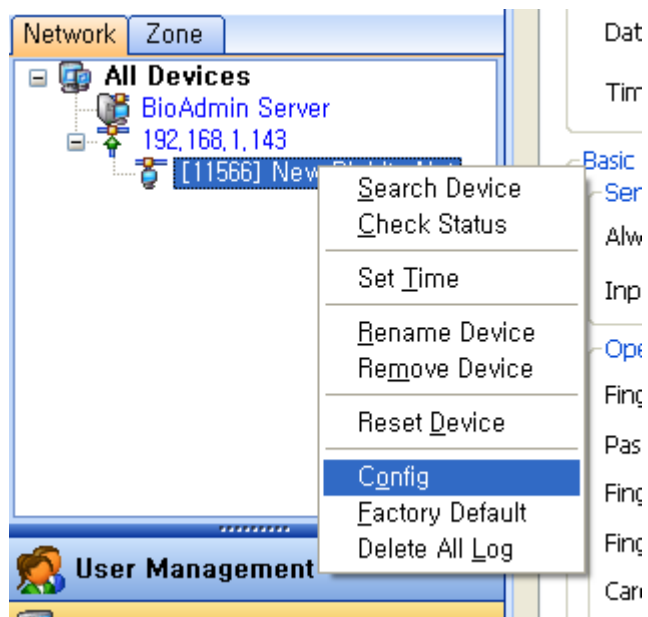

- 'Config' menu may be selected by clicking right mouse button on BioLite Net Icon or a name.

BioEntry Plus / BioLite Net Network Setting

192.168.1.143(11566)

System Information

ID 11566 Refresh

MAC 00:17:fc:20:2d:2e Reset Device

Network Setting

Use DHCP Save

Use Server Refresh

Time Sunc with Server

IP Address 192 . 168 . 1 . 143

Gateway 192 . 168 . 1 . 10

Subnet Mask 255 . 255 . 255 . 0

Server IP 0 . 0 . 0 . 0

Port 1471

OK

- System Information : Show the ID and MAC address assigned to BioLite Net at present; if clicking Refresh button, it reads the information again.
- Network Setting
  - Use DHCP
    - Check it if the BioLite Net is to be automatically assigned with IP
  - Use Server
    - Check it if BioLite Net is connected to BioAdmin Server and operates.
    - Check it to synchronize temporary with server
  - Port
    - Use the same value with the BioLite Net port and the server port.

### 5.8.3. Operation Mode



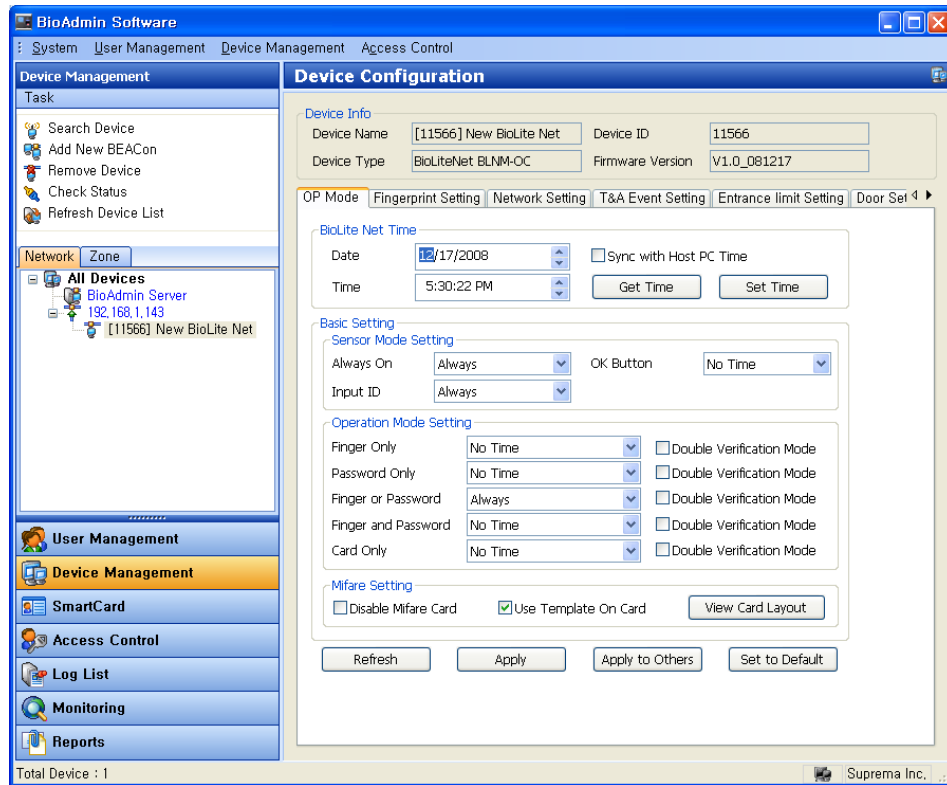

● BioLite Net Time Setting

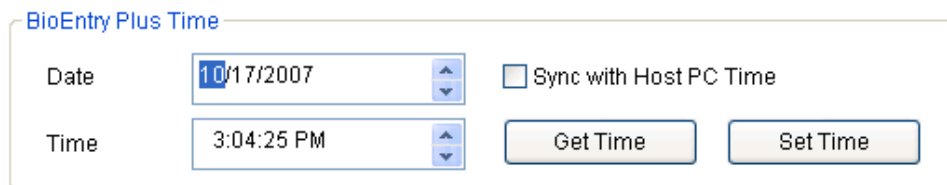

- Date & Time : Read from BioLite Net device.
- “Get Time” button makes BioAdmin read from BioLite Net.
- There are two methods to read a date & time shown as below.
  - Manual Type : Just type date & time manually and pressing ‘Set Time’ button makes them transfer to BioLite Net device.
  - ‘Synchronize with Host PC Time’ : Check it and press ‘Set Time’ button to transfer to BioLite Net device.

- Sensor Mode Setting
  - Always On (Always, No Time)
  - Input ID (Always, No Time)
  - OK Button (Always, No Time)

Each setting can be duplicate and operates when the selected time comes.

Sensor Mode Setting

Always On	Always	OK Button	No Time
Input ID	Always		

- Operation Mode Setting

Operation Mode Setting

All	Always	<input checked="" type="checkbox"/> Double Verification Mode
Card+Fingerprint	No Time	<input type="checkbox"/> Double Verification Mode
Only Card	No Time	<input type="checkbox"/> Double Verification Mode
Fingerprint	No Time	<input type="checkbox"/> Double Verification Mode

- BioLite Net has 5 operation mode setting options from No.1 to No. 5. each option may be assigned for its time.
- Double Verification Mode: Door is operated as long as different user verifications should be executed within 15 seconds.

Note : Double Verification mode is specially designed for two user's verification for secure access control.

- Mifare Setting

In case of BioEntry Plus Mifare model, Mifare Setting option will be appeared.

**Mifare Setting**

Disable Mifare Card       Use Template On Card      [View Card Layout](#)

- **Disable Mifare Card**  
Disable Mifare card, and not to accept card input.
- **Use Template On Card**  
Configure whether it uses template on card or Card ID such as RF-card type by storing template information on the Mifare card.
- **View Card Layout**  
Verify Mifare Layout information of BioEntry Plus, which can be referred at “6.5.7 Configuration of Mifare card layout edit page (BioStation / BioEntry Plus)”.

#### 5.8.4. Fingerprint Setting

**Fingerprint Setting**

Security Level:  1:N Fast Mode:

Scan Timeout:  Matching Timeout:

- **Security Level : Normal, Secure, More Secure**  
Control FAR (False Acceptance Rate) internally. The more FAR, the less FRR (False Rejection Rate), so default is normal level.
- **1:N Fast Mode : Auto, Normal, Fast, Faster**  
In case more than hundreds fingerprints are saved in device, 1:N mode may take longer. If you set fast mode as fast or fastest, performance is somewhat low but 1:N recognition can take less time. Default is normal.
- **Scan Timeout : 1~20 sec**  
User can designate the standby time when entering fingerprint. If a user doesn't enter fingerprint within this time, it is construed as input failure. Default is 10 sec.
- **Matching Timeout : 0~10 sec**  
After fingerprint enrollment, it can assign max. time in sec until verification result comes. If a time is over the assigned time, fingerprint search stops without seeing verification result. This is specially designed for users who are waiting for longer

search time against lower templates.

- Template Option Information

**Template Option Informations**

ISO Format

- ISO Format  
Display BioEntry Plus uses ISO 19474-2 Template Format Data. In case of 'On', it cannot use Suprema format template.
- Check Fake Finger  
Examine fake fingerprint of the enrolled fingerprint when trying verification. Since it is designed to deny against fake fingerprint and it might deny normal fingerprint, you may feel lower verification rate.

### 5.8.5. Network Setting

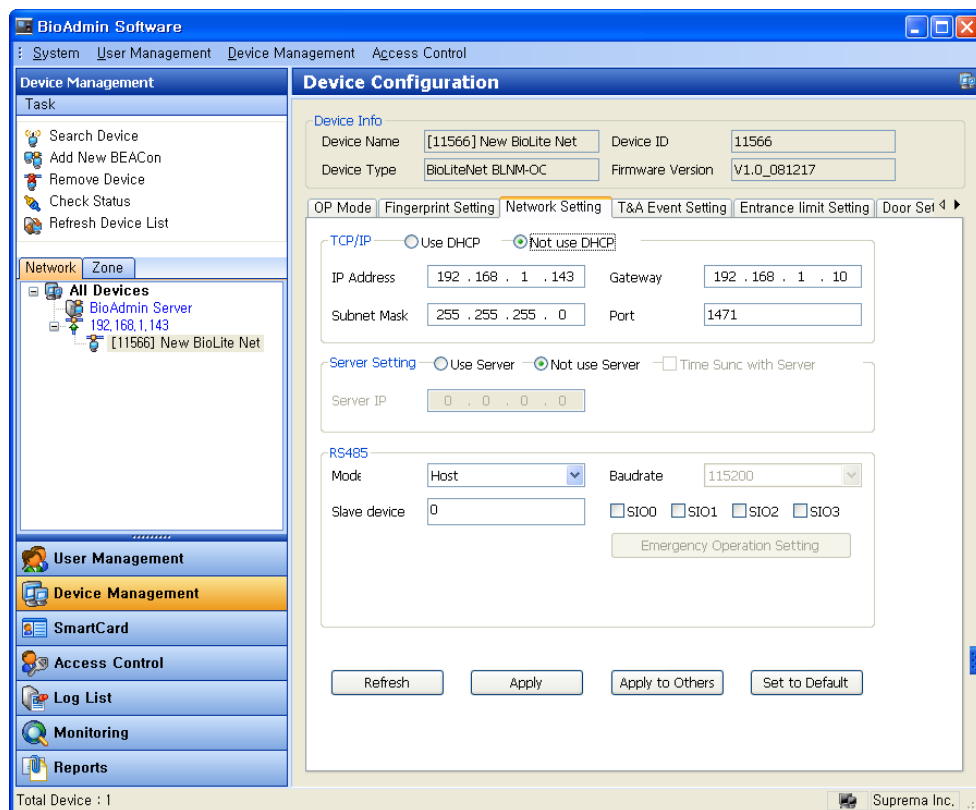

- TCP/IP
  - It selects whether to receive IP address automatically from the settings of BioLite Net or be manually set. If the IP address is set as DHCP to BioLite Net or if directly setting 'Use DHCP', select 'Not use DHCP'.
  - Set the IP address, gateway, subnet mask, and port as proper values.
  - Port (default: 1471) is operated as a server port if it uses server.
- Server Setting
  - It shows whether the BioLite Net is connected to server
  - If connecting BioLite Net that is connected to general TCP/IP, not a server, to server, check 'Use' and set the server IP address and the server port.
  - As such, if connected to a server, the BioLite Net is connected to it and disconnected from the TCP/IP immediately. It may take a time until it is reconnected to the server again.
  - If the communication status of BioLite Net connected to the server is not good, click the right mouse button on BioAdmin Server and try to reconnect to server.
  - RS485

Use for RS-485 communication of BioLite Net. In RS-485 mode, the connected devices take a role as 'Host' and 'Slave'. Suprema's new total integrated system including BioStation, BioEntry Plus, BioLite Net, and Secure I/O is consist of 1 host device, 1 slave device, and max. 4 Secure I/O. Host device has total 10 relay and 20 input. Please refer to the "Secure I/O Installation Guide" and "4.5.3 Network Setting" of BioStation in this manual for further information.

    - Mode : PC Connection, Host, Slave, None
    - Baudrate
    - Slave Device
    - SIO default Setting

The screenshot shows a dialog box titled "Emergency Operation Setting". It has a blue title bar with a close button. The main area is light beige. At the top, there is a "Device" dropdown menu with "Secure I/O #0" selected. Below this is an "Input" section with a "Port" dropdown menu (Input #0), a "Switch Type" dropdown menu (N/O), and a "Duration(ms)" text input field (0). Below the "Input" section is an "Output" section with a "Port" dropdown menu (Output #0), a "High(ms)" text input field (0), a "Low(ms)" text input field (0), and a "Count" text input field (0). At the bottom of the dialog are two buttons: "Save" and "Cancel".

#### 5.8.6. T&A Event Setting

T&A function key is used for typing time & attendance before enrolling fingerprint such as In, Out, In Duty, or Out Duty used in BioStation. In case of BioLite Net, you can select T&A event key using arrow button (< , >), which can be used up to 16 keys. Firstly, selecting T&A event in BioLite Net device, place your fingerprint, then the corresponding T&A event will be saved in log, which will be used for time & attendance and payroll data.

Please check both "T&A Event Setting" in Device Management and "T&A Event Setup" in Reports menu.

- T&A Event Function Key : Same setting as BioLite Net's device
- T&A Event Setup : Setting for recording T&A event to generate a report

The log of BioLite Net records the number of pressed event key, not real T&A event list, then BioAdmin reads this value and generates T&A report by referring between pre-defined function key and T&A event tables. Therefore, T&A event in this setting won't be appeared in report or log.

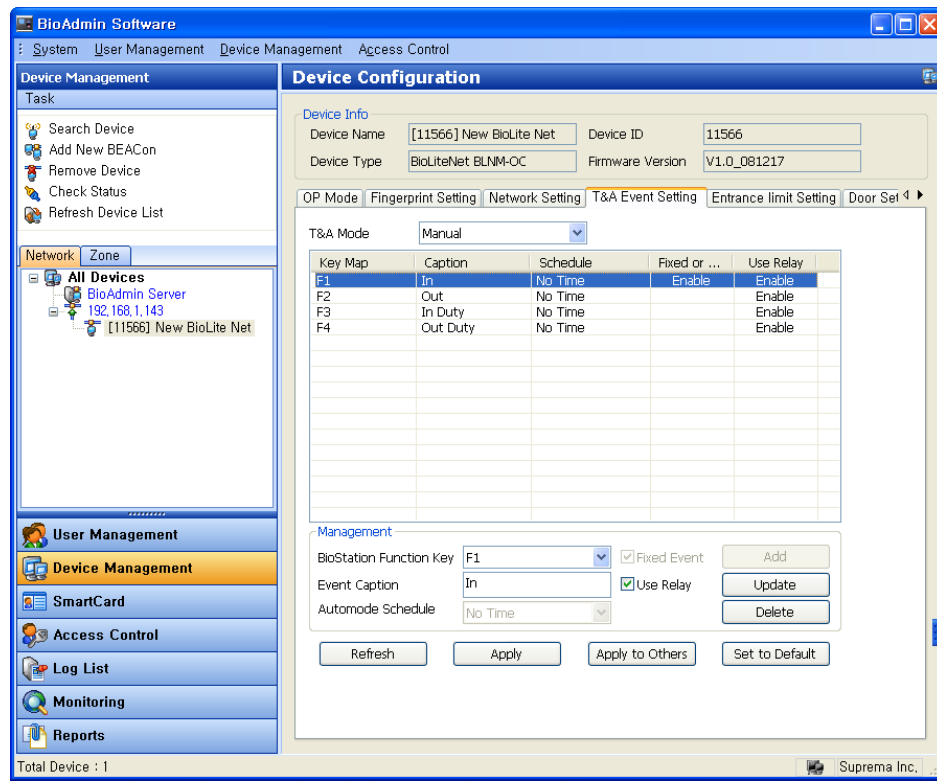

You can select one of 16 events, check event message appeared in BioLite Net LCD screen and relay availability.

- Select one of T&A Modes following as:
  - Not Use : Select in case of not using T&A mode
  - Manual : Select for necessary case, normally does not use event
  - Manual Fix : After selecting a specific event by user, keep to use identical event before modifying by another user
  - Auto Change : Select for auto changing by pre-defined time zone from administrator
  - Event Fix : Select for always identical event
- Select one of BioStation Function Key, which won't be existed in BioLite Net, but it works same functions in BioLite Net.
- Type the name of event in Event Caption field.
- Determine door open availability to enable/disable relay of the selected event.

Relay is generally used for opening & closing a door connected to lock controller.

- In case of selecting Event Fix T&A mode, 'Fixed Event' will be highlighted. For example, In/Out event will be applied.
- In case of selecting Auto Change T&A mode, 'Automode Schedule' will be highlighted, which can be automatically applied to each function key by selecting pre-defined entrance limit setting.

### 5.8.7. Entrance Limit Setting

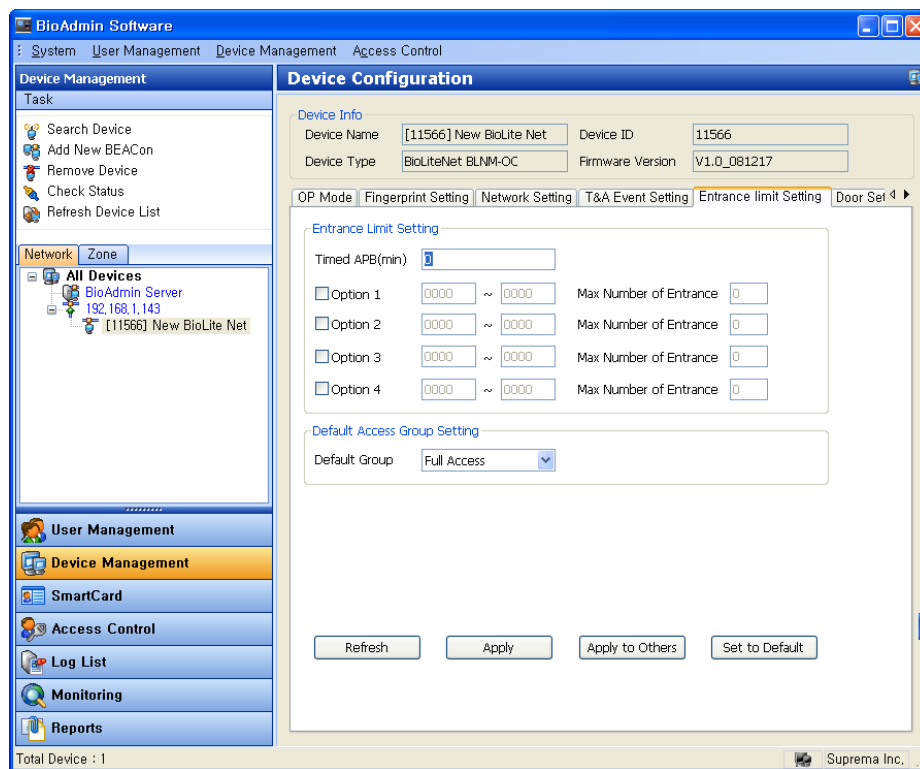

- Entrance Limit Setting
  - Timed APB : Limit verification if re-verification is not attempted for a specified time (minute).



- Options 1~4 : If entering start time ~ end time of each option and specifying the max. access allowance number for the time, it allows the only number of access for the specified time.
- Automatic T&A Mode Change
  - Set in which attendance mode BioLite Net is used.
  - T&A mode : Not use, Fixed in, Fixed out, Auto
    - Auto Mode: if authentication is approved for a specified time, its attendance mode is automatically converted to Entrance or Exit.
    - Fixed in / Fixed out mode: Set the attendance mode to either entry or exit among entrance or exit.
- Default Access Group Setting

In case of a user with no access group information, it may set a user to be grouped in an access group.

#### 5.8.8. Door Setting

- The detail setting of door that is operated by each device may be set up.

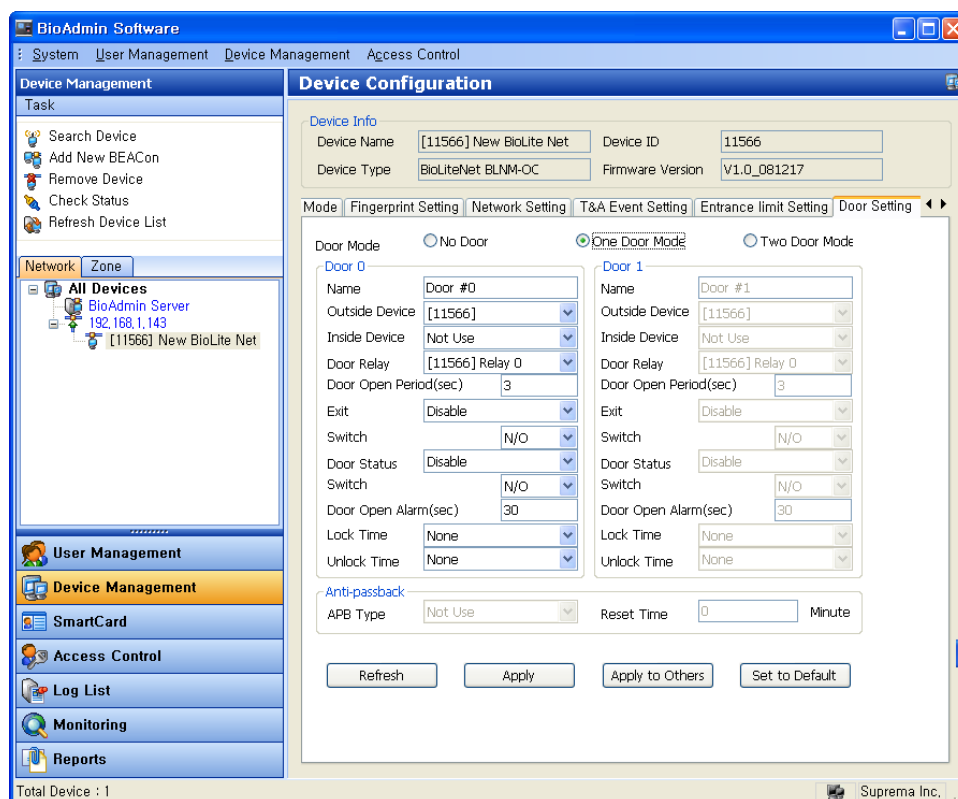

- Outside / Inside Device : Set two devices to control 1 door.
- Door Relay : Set the output terminal to control door among the connected devices.
- Door Open Period (sec) : Set the time when the selected output terminal operates in door open relay.
- Exit Button : Select a button input terminal used to open entrance door, which is Input 0 for use (N/O : Normal Open , N/C : Normal Close).
- Door Status : Select an input terminal to connect a sensor used to check the status of entrance door (N/O or N/C), which is Input 1 for use.
- Door Open Alarm (sec) : Enter the time to determine whether entrance door is open for a long time.
- Driven By : Select an event when an entrance door is open for a time longer than the set 'Long Time Door Open' setting.
- Lock Time : Set the time when a designated entrance door is always closed, as an item inter-working with the entrance/exit time set in entrance control item.
- Unlock Time : Set the time when a designated entrance door is always opened,

as an item inter-working with the entrance/exit time set in entrance control item.

- Anti-passback : Set whether to apply anti-passback between Outside and Inside device.
  - Soft : Make a record and allow entrance in case of not verifying APB.
  - Hard : Not allow record and entrance in case of not verifying APB.
  - Reset Time : Make clearing entrance limit time against APB limit.

### 5.8.9. I/O Setting

- Window to set I/O terminals as use's discretion, besides door.

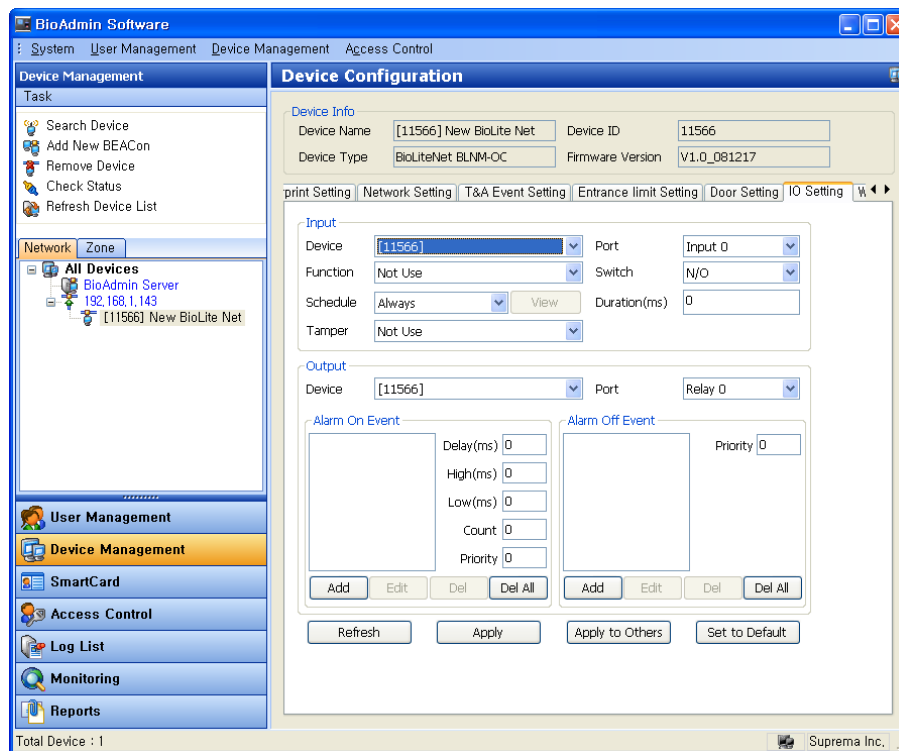

- Input

**Input**

Device	[11566]	Port	Input 0
Function	Not Use	Switch	N/O
Schedule	Always	Duration(ms)	0
Tamper	Not Use		

View

- **Device Type** : Display the device to be set at present.
- **Function** : Select a function to be performed as an input.
- **Schedule** : Set the input to be operated only for the time set in access control
- **Tamper** : Set to designate the function of tamper.
- **Port** : Select an input terminal set in the selected device.
- **Switch Type** : N/O or N/C
- **Duration(ms)** : Operate as long as the longer time is entered

● Output

**Output**

Device	[11566]	Port	Relay 0
--------	---------	------	---------

**Alarm On Event**

Delay(ms)	0
High(ms)	0
Low(ms)	0
Count	0
Priority	0

Add Edit Del Del All

**Alarm Off Event**

Priority	0
----------	---

Add Edit Del Del All

- **Device** : Display the devices to be set at present.
- **Port** : Select an output terminal to be set in a selected device.
- **Alarm On Event** : It may set so that if a listed event occurs, the output is generated from the port of a selected device.

● How to add Event

**Add Event**

[11566] Relay 0

**Event**

Event: Auth Success

Device: All Devices Priority: 1

**Signal Setting**

Delay(ms): 0 Count: 1

High(ms): 0 Low(ms): 0

OK Cancel

- **Event** : It is set so that if a selected event occurs, the output is generated to the port of the previously selected device.
- **Device** : Select a device to generate an event.
- **Priority** : By allowing priority to a function, it may prevent a priority event from being hidden or turned off, preceding over low priority function.
- **Signal Setting**
  - Delay: delay time before output is generated
  - Count: frequency to repeat off ~ on interval
  - High: time when output is generated
  - Low: Time when output is not generated
- **Alarm Off Event**

If a listed event occurs, it may release an output of which priority is equal to or lower than the priority of the port of a selected device.

#### 5.8.10. Wiegand

- Wiegand tab is used to manage the Wiegand I/O format. If selecting the menu, Wiegand setting page is updated on the window.

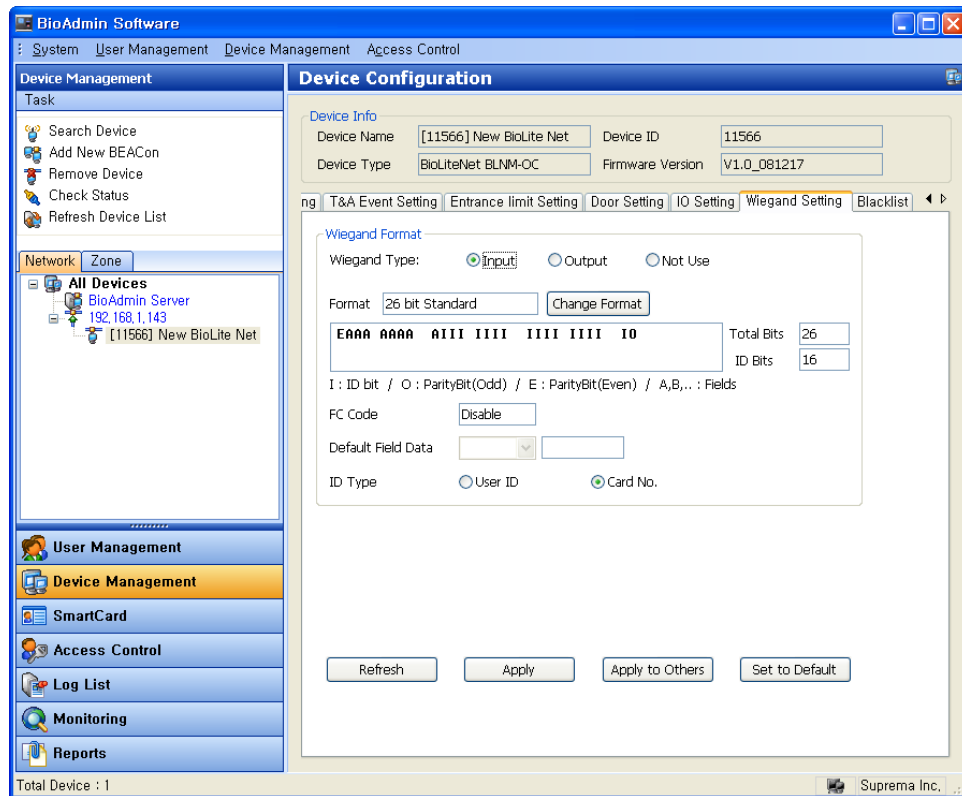

- Wiegand format

It is possible to set new Wiegand format by using Wiegand setting wizard. Pressing Format change shows the Wiegand Setting wizard.

Select one of three formats supported in the first page.

- 26 bit standard Wiegand format

26 bit standard format is the most widely used and consist of 8 bits FC code and 16 bits ID. In 26 bits standards formation, bit definition and parity bit may not be changed.

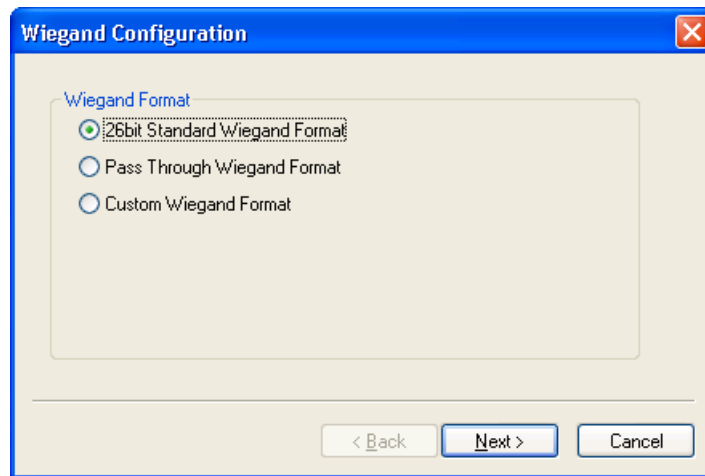

- **Pass Through Wiegand Format**

Pass Through Format is used as long as ID field format is known. If Wiegand input string is detected, the device finds ID bits and starts the authentication with the ID. If authentication is successful, the device outputs the Wiegand input string with no change. Parity check and advanced options are disregarded in the format. According to the definition, Pass Through format is available only when the use mode is 1:1. In case of use mode is 1:N, bit order except ID field should be set to 0. Assuming that 32 bit Pass Through format is as follows.:

XIIIIII IIIIIIX XXXIIII IIIIIIX

(the very left bit is 0th bit, BIT0) I: Id field, X: Unknown field

The format can be set as the following sequence.

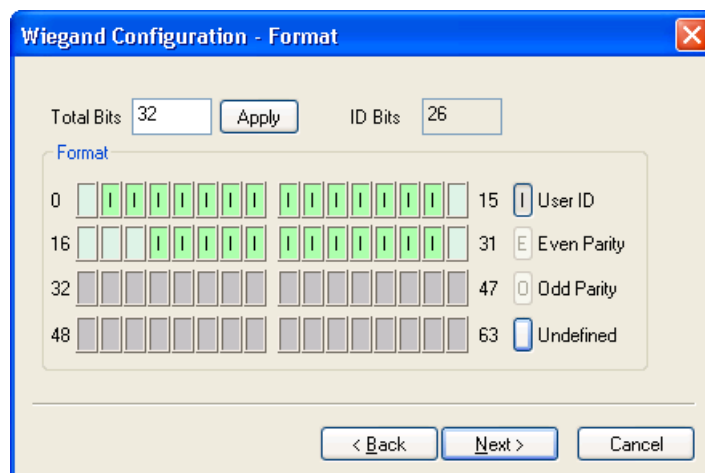

- Input 32 into Total Bits field.
- Select a ID bit according to the definition.
- Press Next button. In pass through mode, parity bit may not be specified.
- **User-defined Wiegand format**  
 If a user has the overall information for Wiegand format, the user may set the customized format. If Wiegand input string is detected, the device checks the parity bit first of ally. If every parity bit is correct, the device extracts ID bit and starts the authentication with the ID. A user may set each field with other values and set advanced option such as Fail ID. If authentication is successful, the output strings may differ from input string, depending on replaced values and advanced options.

Assuming that 44 bit customized format is structured as follows:

EAAAAAAAA IIIIIIII IIIIIIII BBBBBI IIIIIIII IIIIO

- (the very left bit is 0th bit, BIT0)
- E: Even parity for BIT1 ~ BIT22
- O: Odd parity for BIT23 ~ BIT42
- I: ID bits(Field1 and Field 3), A: Field 0, B: Field 2

The format may be set as the following sequence.

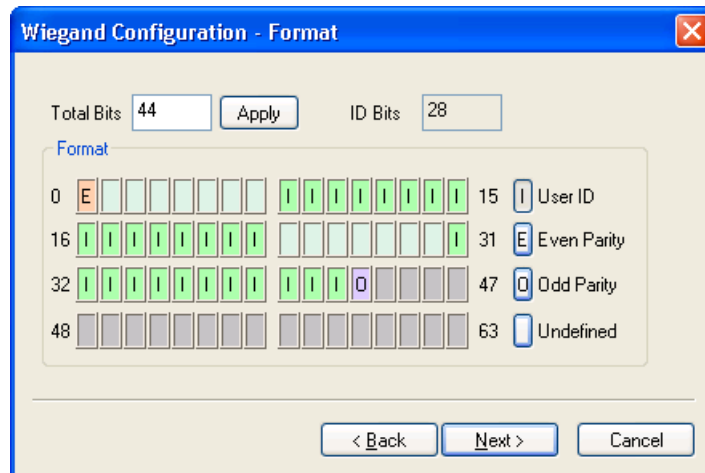

- Enter 44 into Total Bits field.
- Select Even Parity.
- Press 'even parity bit'. In the example, it means BIT0.
- According to the definition, repeat (2) and (3) for Odd Parity and User ID.
- Press Next button.



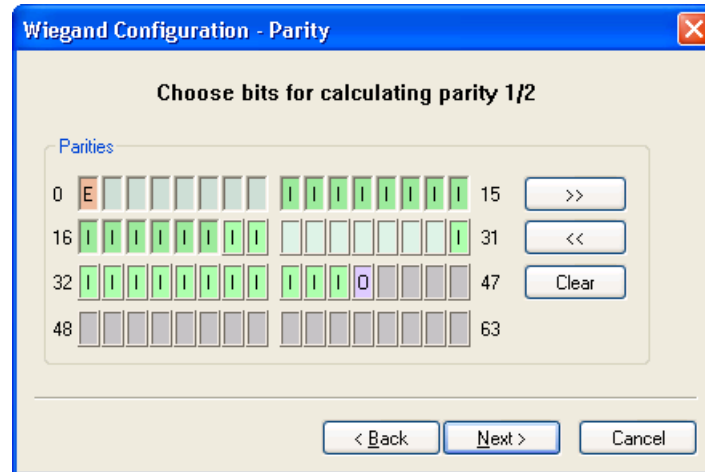

- Press the buttons used to calculate the first parity bit. In the example, they are BIT1 ~ BIT22.
  - Press >> button.
  - Press the buttons used to calculate the second parity bit. In the example, they are BIT23~ BIT42.
  - Press Next button.
- Replaced value
 

In 26 bit standard, it is possible to specify another FC code. In customized format, it is possible to specify the replaced value in non-ID field. If the replaced value is set, the device change the fields with the replaced values.

#### 5.8.11. Black List





## 5.9. Manage BioEntry device

By selecting a BioEntry on the Device tree, the Device Configuration window for the selected BioEntry is updated on the main window.

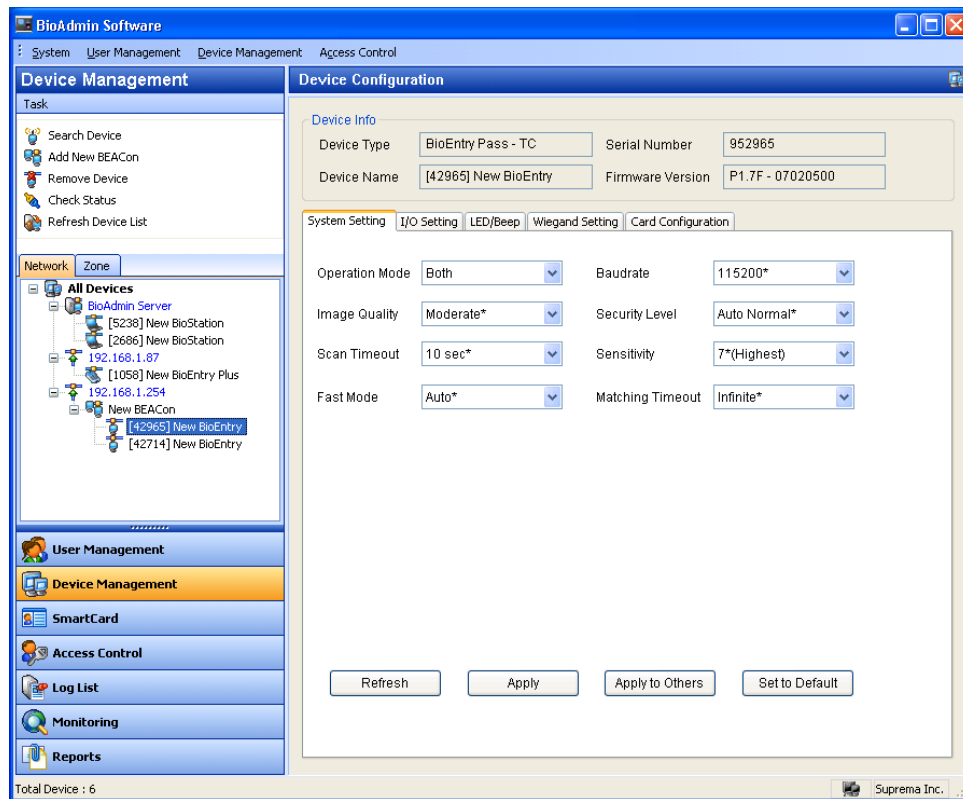

Device Configuration window is divided into 2 sectors:

- **Device information**  
Device information shows the model name, serial number, device name, and firmware version of the selected BioEntry.
- **Configuration Set up window**  
The configuration set up window shows the current configurations of selected BioEntry. Also, this window shows the configurations to be changed. The configuration set up menus are divided by separate tabs, such as System setting, I/O setting, LED/BEEP setting, Wiegand setting, and Card Layout.

### 5.9.1. Device information

Administrator can check device name, device type, device ID and FW version of

BioEntry. Device ID number and FW version are necessary information to check a product for technical support after installation.

## 5.9.2. System Setting

User can set up the parameters of BioEntry on the **System tab**. When this tab is selected, the system setting page is updated on the main window.

Setting	Value
Operation Mode	Both
Image Quality	Moderate*
Scan Timeout	10 sec*
Fast Mode	5(Fastest)
Baudrate	115200*
Security Level	Auto Normal*
Sensitivity	7*(Highest)
Matching Timeout	Infinite*

Buttons: Refresh, Apply, Apply to Others, Set to Default

### ● Operation Mode

- 1:1 verification : if 1:1 mode is selected in BioEntry Smart, present user smart card first and finger scan starts. In case of BioEntry Pass, finger scan is processed by Wiegand input from external device such as ID card or user fingerprint.
- 1:N identification : in 1:N mode, finger scan (authentication) is done with user's fingerprint only. As device sensor is always on input standby mode, 1:N scan starts right away once a finger is placed on.
- Both : Both 1:1 verification and 1:N identification are supported.

- Baud rate : Baud rate is the number of times per second that the carrier signal value changes state. If you have some problems to communicate with BioEntry or with BioStation, changing baud rate to lower value can be a solution.
- Image Quality : When a fingerprint is scanned, the module will check if the quality of the image is adequate for further processing. The image quality parameter specifies the strictness of this quality check.
- Security Level : Security level specifies FAR(False Acceptance Ratio). If it is set to 1/100,000, it means that the probability of accepting false fingerprints is 1/100,000. Since FAR and FRR(False Rejection Ratio) is in inverse proportion to each other, FRR will increase with higher security levels. Default value is **Auto Normal**.
- Scan Timeout : Scan Timeout specifies the timeout period for user input. If a user does not make his/her finger scanned, place smartcard, or input Wiegand during this period, error will be returned.
- Sensitivity : Sensitivity specifies sensor sensitivity to detect a finger. On high sensitivity, the module will accept the finger input more easily. In other hand, by decreasing the sensitivity, the input fingerprint image will be more stabilized. In case of optical models, sensitivity to sunlight is also alleviated by decreasing sensitivity parameter. Default value is **7**.
- Fast Mode : When more than hundreds of templates are stored in BioEntry, the matching time for 1:N identification can be very long. Fast Mode parameter can be used to shorten the 1:N matching time with little degradation of authentication performance. The security level – FAR – is not affected by this parameter, but the FRR can be a bit higher than in normal mode. In typical cases, Fast Mode 1 is as 2 ~ 3 times faster than Normal mode. And Fast Mode 5 is 6 ~ 7 times faster than Normal mode. Default value is **0**.
- Matching Timeout : Timeout period for 1:N matching. If identification process is not finished during this period, error will be returned.

● Factory defaults of parameters

BioEntry Factory defaults list of parameters for BioEntry Pass is as follows :

	Factory defaults	Selectable values
Operation mode	1:1 verification (BioEntry Smart)	1:1 verification 1:N identification

	1:N verification (BioEntry Pass)	Both
Security level	Auto Normal	1/1,000 3/10,000 1/10,000 3/100,000 1/100,000 3/1,000,000 1/1,000,000 3/10,000,000 1/10,000,000 3/100,000,000 1/100,000,000 Auto Normal Auto Secure Auto More Secure
Image quality	Moderate	Weak Moderate Stronger Strongest
Sensitivity	7	0(lowest) to 7(highest)
Scan timeout	10 sec	1 to 20 sec or Infinite
Matching timeout	Infinite	1 to 20 sec or Infinite
Fast mode	0(Normal)	0(Normal) to 5(Fastest)

### 5.9.3. I/O Setting

BioEntry provides 2 programmable inputs and 2 programmable outputs which can be used to interface with external devices. **I/O Setting** menu refreshes the main window to manage the I/O settings. By factory default, no functions are defined for each programmable I/O's.

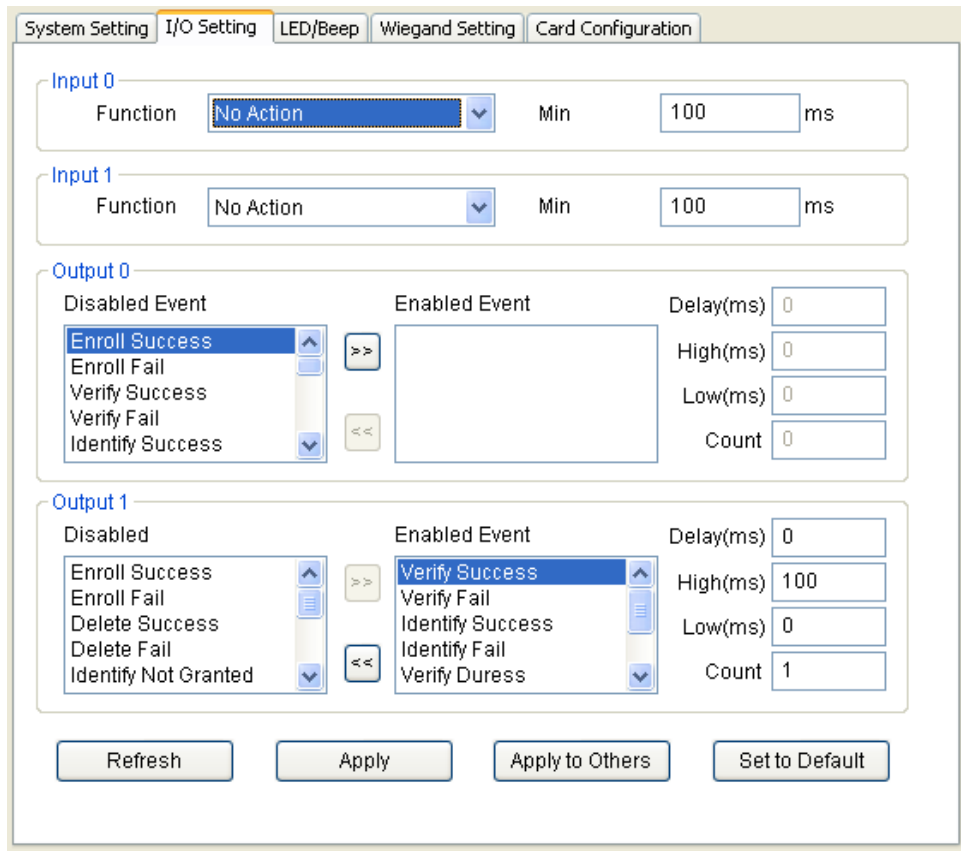

- Configuration of input port

To define the configuration of input port, function and minimum duration should be specified. Function means what to do when the input port is activated and minimum duration means the required duration of pulse to activate the input port.

- Description of Input functions

Function	Description
No Action	Disable input port
Enroll by Scan	initiate enrollment using finger scan
Identify by Scan	initiate identification using finger scan
Delete by Scan	delete user by identifying input finger
Delete All	delete all user data
Enroll by Wiegand ID	enroll by scan with user ID received at Wiegand input port
Verify by Wiegand ID	initiate verification using finger scan with user ID



	received at Wiegand input port
Delete by Wiegand ID	delete user with user ID received at Wiegand input port
Controller Reject	input for reject signal from controller
Controller Accept	input for accept signal from controller
Software Reset	initiate software reset

- Program sample for input port
  - If administrator wants to connect the wiegand input of the user ID to the input button to initialize enrollment, the following procedure is required.
  - Suppose to use input port 0, user should press a button for at least 500 ms to activate a function.
  - First, choose applicable device on device list window.
  - Choose a function of input port 0 with Enroll by Wiegand ID.
  - Input 500 as minimum input time of input port 0.
  - Press apply button to transfer new settings to applicable device.

- Configuration of output port

In configuring output port, multiple functions can be programmed to produce different output pattern on each event. Event means when to activate the output port and output pattern defines how to activate the output port, respectively. Programming procedure is as follows:

- Enable required event by selecting event from disabled event.
- Program output pattern by editing delay, high, low, and count values.

- Output events

Event	Description ( when to activate the output port )
Enroll Success	When a user is successfully enrolled on the device
Enroll Fail	When enrollment fails
Identify Success	When identification is successfully done
Identify Fail	When the device fails to find out the matched user
Verify Success	When verification is successfully done
Verify Fail	When the user is not verified
Delete Success	When deletion of user succeeds
Identify Not Granted	Identification is successfully done, but entrance denied

Verify Not Granted	Verification is successfully done, but entrance denied
Delete Fail	When deletion of user fails
Verify Duress	When duress finger is verified
Identify Duress	When identified finger is a duress finger
Temper Switch On	When temper switch on the device is enabled implying device is opened.
Command Card Success	When command card operation successfully completed
Command Card Fail	When command card operation is failed
Controller Reject	When input port on which Controller Reject function is assigned, is activated
Controller Accept	When input port on which Controller Accept function is assigned, is activated
Detect Input 0	When input port 0 is activated regardless of assigned function
Detect Input 1	When input port 1 is activated regardless of assigned function

● Describing output pattern

On each enabled event, output pattern can be flexibly described by programming using 4 parameters whose meanings are depicted as

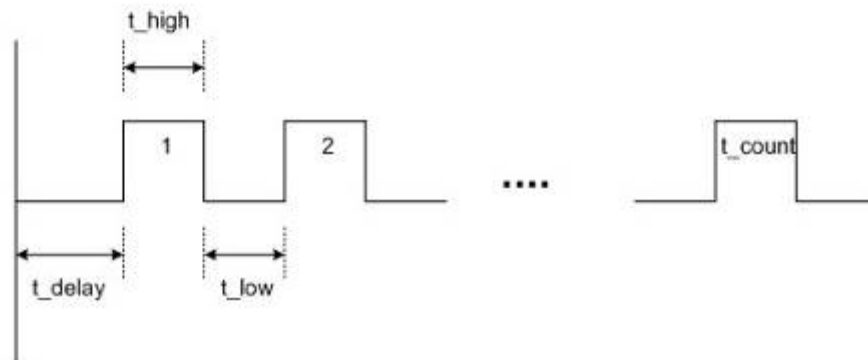

Parameter	Meaning	Allowed value
Delay	initial delay before generating output pulses in msec	0 ~ 65535

High duration	duration of pulse in high state in msec	0 ~ 65534 65535 : continuously active until new output event occurs
Low duration	interval between consecutive pulses where the output signal remains low	0 ~ 65535
Count	Number of pulses	0 : infinitely repeated until new output event occurs 1 ~ 255

- Programming example of output pattern

Assume that a user want to assign an alarm signal at output port 0 generating following patterns:

- On identification success or verification success for duress finger, the device sends blinking output during 5 seconds.
- When temper switch is on, the device sends steady output during 10 seconds.
- Programming procedure is as follows:
  - First, select a target device on the network window.
  - Disable currently selected events on output 0 by moving enabled ones to the disabled sector.
  - Program the required events by enabling each event followed by editing output pattern parameters as follows:

Event to be enabled	Output pattern parameters
Verify Duress	Delay : 0 High : 500 Low : 500 Count : 5
Identify Duress	Delay : 0 High : 500 Low : 500 Count : 5
Temper Switch On	Delay : 0 High : 10000

	Low : 0
	Count : 1

- Press the Apply button to transmit the new configuration to the target device.

#### 5.9.4. LED/Beep sound Setting

There are two LED's and one beep on BioEntry device to provide processing status and result to users. The colors of two LED's are mixed to generate 3 colors, green, red, and amber. By selecting the LED/Beep Setting tab, the LED/Beep configuration page is updated on the main window.

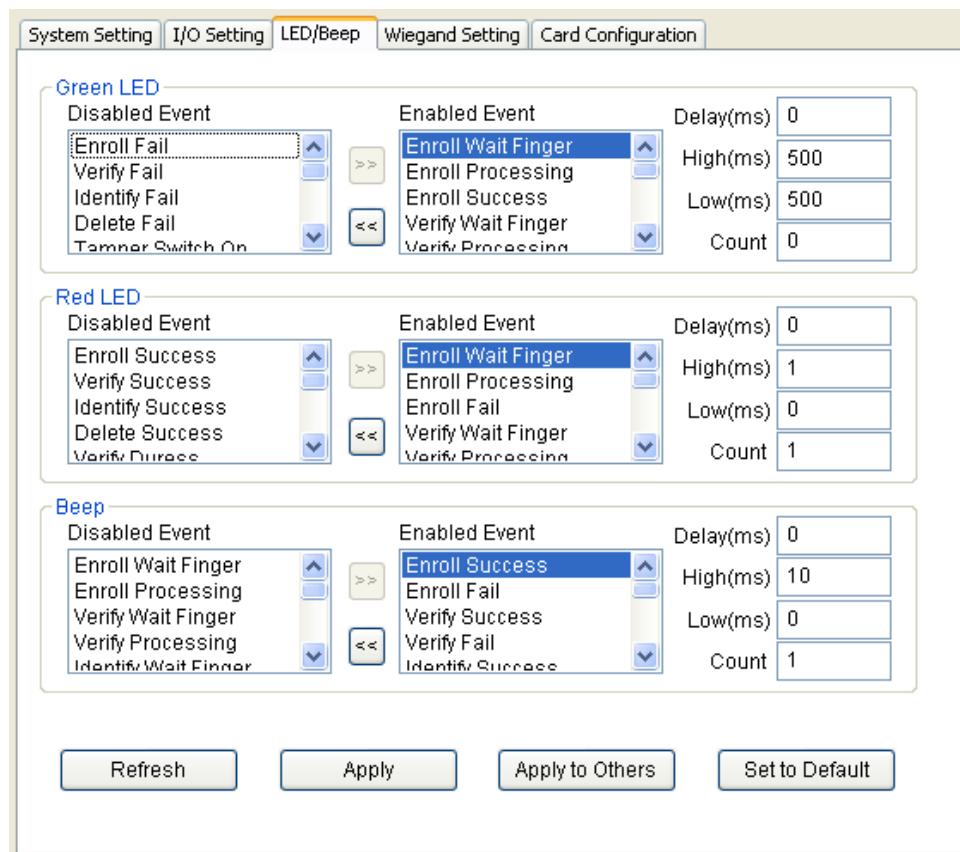

- Configuration of LED/Beep  
 Programming steps for LED and Beep is similar to output port configuration. Additional events are selectable, listed as

Event	Description ( when to activate the output port )
Enroll Wait Finger	When the device is waiting for a finger scan to enroll
Enroll Processing	When the device is in enrollment process
Identify Wait Finger	When the device is waiting for a finger scan to identify
Identify Processing	When the device is in identification process
Verify Wait Finger	When the device is waiting for a finger scan to verify
Verify Processing	When the device is in verification process
Delete Wait Finger	When the device is waiting for a finger scan to delete

- Description of default LED/Beep configuration

By factory default, various output patterns are defined for LED and beep to show current status and processing result. The description of default LED/Beep configuration is listed as follows:

Events	LED	Beep
Enroll Wait Finger	Slow blinking amber	None
Verify Wait Finger	Fast blinking amber	None
Identify Wait Finger	Slow blinking amber	None
Delete Wait Finger	Fast blinking amber	None
Enroll Processing Identify Processing Verify Processing	Steady amber	None
Enroll Success Verify Success Identify Success Delete Success Command Card Success Verify Duress Identify Duress	Steady green	One beep sound
Enroll Fail Verify Fail Identify Fail Delete Fail Command Card Fail	Steady red	Three short beep sounds
Waiting Smart Card Input	Fast blinking red (fixed)	None

### 5.9.5. Wiegand Setting

The **Wiegand Setting** tab is used to manage the Wiegand input/output format of BioEntry. By selecting the menu, the Wiegand setting page is updated on the main window.

- **Wiegand Format**  
New Wiegand format can be configured graphically using the Wiegand Configuration wizard. The Wiegand Configuration wizard will be shown by pressing the **Change format** button.
- **Select format**  
You should select one of the three supported formats in the first page. If BioEntry device is connected to the controller by ABA Track II output, not by Wiegand interface, you should check **Use ABA Track II**. In that case, the output signal will be in ABA Track II format. You can also specify the number of

characters for ABA Track II output.

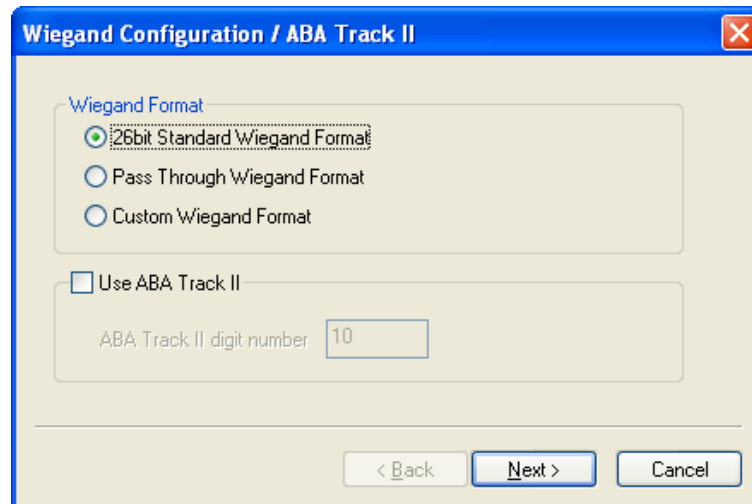

- 26 bit standard

The 26 bit standard format is most widely used and consists of 8 bit FC code and 16 bit ID. You cannot change the bit definition and the parity bits in 26 bit standard format.

- Pass Through format

Pass Through format is used when only the format of ID field is known. When the Wiegand input string is detected, BioEntry device extracts ID bits and starts verification with the ID. If the verification succeeds, the device outputs the Wiegand input string as unchanged. Parity check and advanced options are ignored in this format. By definition, Pass Through format is only useful when the operation mode is 1:1. If the mode is 1:N, the bits other than ID field are set to 0.

For example, assume that 32 bit Pass Through format is composed as follows:

XIIIIII IIIIIIX XXXIIII IIIIIIX (left most bit is 0th bit, BIT0)

I: Id field, X: Unknown field

You can configure this format in the following sequences.

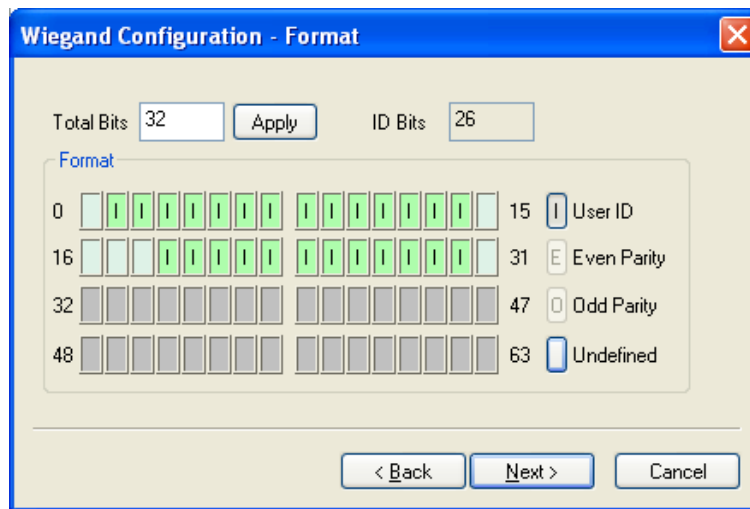

- (1) Enter 32 in the **Total Bits** field.
- (2) Select ID bits according to the definitions.
- (3) Press **Next**. You cannot specify parity bits in Pass Through mode.

▪ **Custom format**

When users know all the information of a Wiegand format, Custom format can be defined. When a Wiegand input string is detected, BioEntry device checks the parity bits first. If all the parity bits are correct, the device extracts ID bits and starts verification with the ID. Users can also set alternative values of each field and enable advanced options such as Fail ID. If the verification succeeds, the device outputs a Wiegand string. The output string may be different from the input string according to the alternative values and advanced options.

For example, assume that 44 bit Custom format is composed as follows:

EAAAAAAAA IIIIIIII IIIIIIII BBBBBI IIIIIIII IIIIO

(left most bit is 0th bit, BIT0)

E: Even parity for BIT1 ~ BIT22

O: Odd parity for BIT23 ~ BIT42

I: ID bits(Field1 and Field 3), A: Field 0, B: Field 2

You can configure this format in the following sequences.



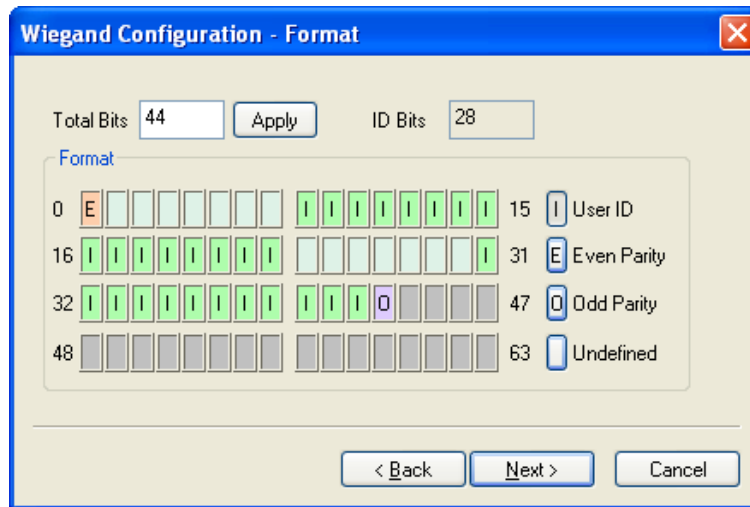

- Enter 44 in the **Total Bits** field.
- Select **Even Parity**.
- Press the even parity bit. In this example, it is BIT0.
- Select Odd Parity and press the odd parity bit and User ID according to the definition.
- Press **Next**.

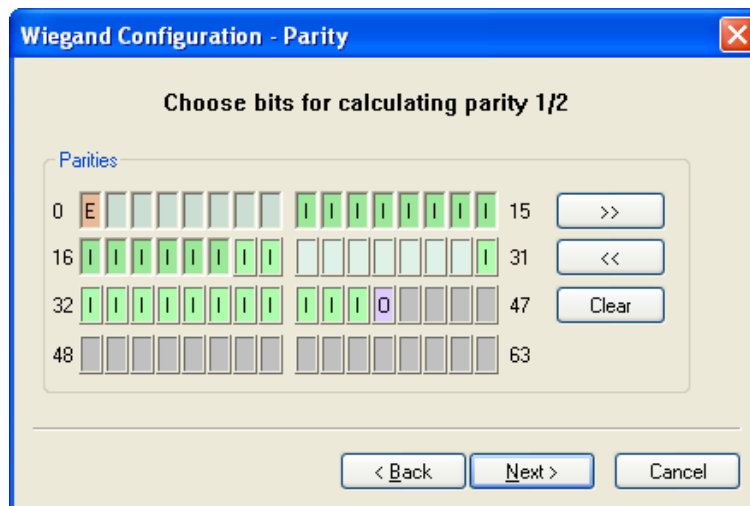

- Press the bits which are used in calculating the first parity bit. In this example, they are BIT1 ~ BIT22
- Press >>.
- Press the bits which are used in calculating the second parity bit. In this example, they are BIT23~ BIT42.
- Press **Next**.

- Alternative values

In 26 bit standard you can specify alternative FC code. In Custom format, you can specify alternative values for non-ID field. If alternative values are set, the BioEntry™ device will replace corresponding fields with these values before sending outputs.

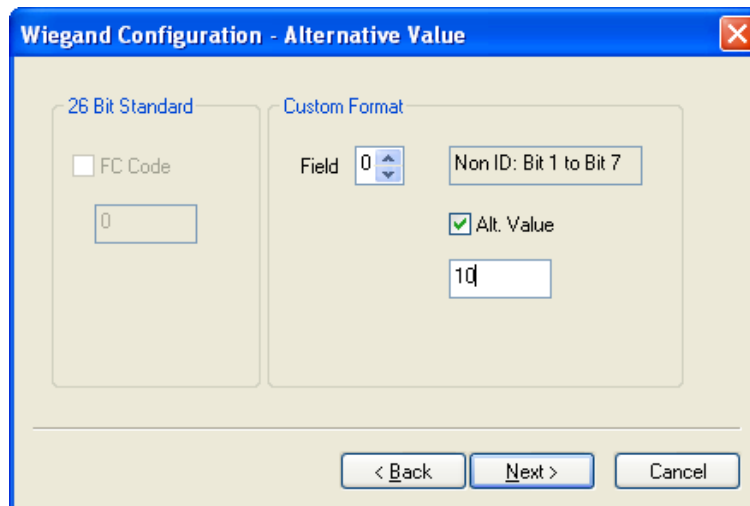

- Advanced options

You can specify the characteristics of Wiegand signal and the advanced options in the last page of the wizard. Advanced options are not available for Pass Through format.

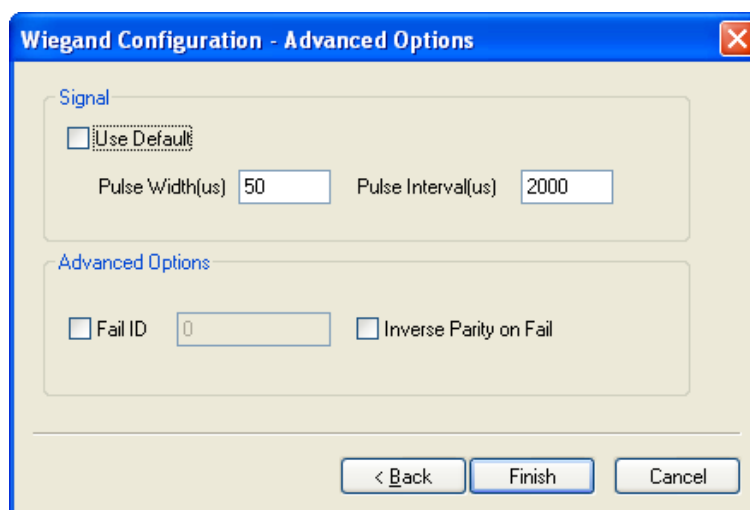

- Use Default: Uses default values for Wiegand signals.

- **Pulse Width** : The width of pulse. The default is 50 us.
- **Pulse Interval** : The interval of pulse. The default is 2000us.
- **Fail ID** : Normally the module outputs Wiegand signals only if matching succeeds. If this option is checked, the module outputs the fail ID when matching fails.
- **Inverse Parity on Fail** : If this option is checked, the module outputs Wiegand signals with inverted parities when matching fails.

### 5.9.6. Smart Card setting

Card Configuration is the process of defining custom sectors on user's smart card to store user information including user ID and templates. By selecting **Card Configuration** menu, smart card layout page is updated on the main window.

**Note :** *It is recommended that only advanced users attempt to change the layout since improper changes may render the smart card unusable. Read this chapter carefully for changing the layout from the default configuration.*

System Setting I/O Setting LED/Beep Wiegand Setting Card Configuration

Smart Card Layout

Template Size 350 (22 blocks) Select CIS Index Select Template Reset Layout

Block Color Key

- CIS Index Block
- Template 1 Data
- Template 2 Data
- Unavailable
- Unused

Refresh Apply Apply to Others Set to Default

- Editing layout

- Template size : Template size is configurable from 254 to 382. By factory default, template size is specified as 350 bytes storing two templates on the card.
- CIS index block : Header information is stored on the CIS index block which is depicted by red color.
- Template data block : Blocks for template 1 data and template 2 data. Number of blocks for each template data is determined by template size. Template 1 data is depicted by yellow and template 2 data is depicted by green, respectively.
- Unused block : Blank block which is not defined by layout.
- Unavailable block : Block that is prohibited from use.

- Editing procedure

To configure customer's layout, following procedures are required.

- Initialize all the blocks to unused ones by pressing the Reset Layout button.
- Select the required template size.
- Press the Select CIS Index button and click an unused block to select a CIS index block.
- Press the Select Template button and click an unused block to indicate the start block of template data. Then, the blocks of template 1 data are set automatically from the selected start block.
- Press the Select Template button again and click an unused block to indicate the start block of template 2 data.
- The Apply button transmits smart card layout to selected devices.

- Factory default layout

Factory default smart card layout is as follows :



## 5.10. BEACon Configuration

By selecting a BEACon on the Device tree, the Device Configuration window for the selected BEACon is updated on the main window.

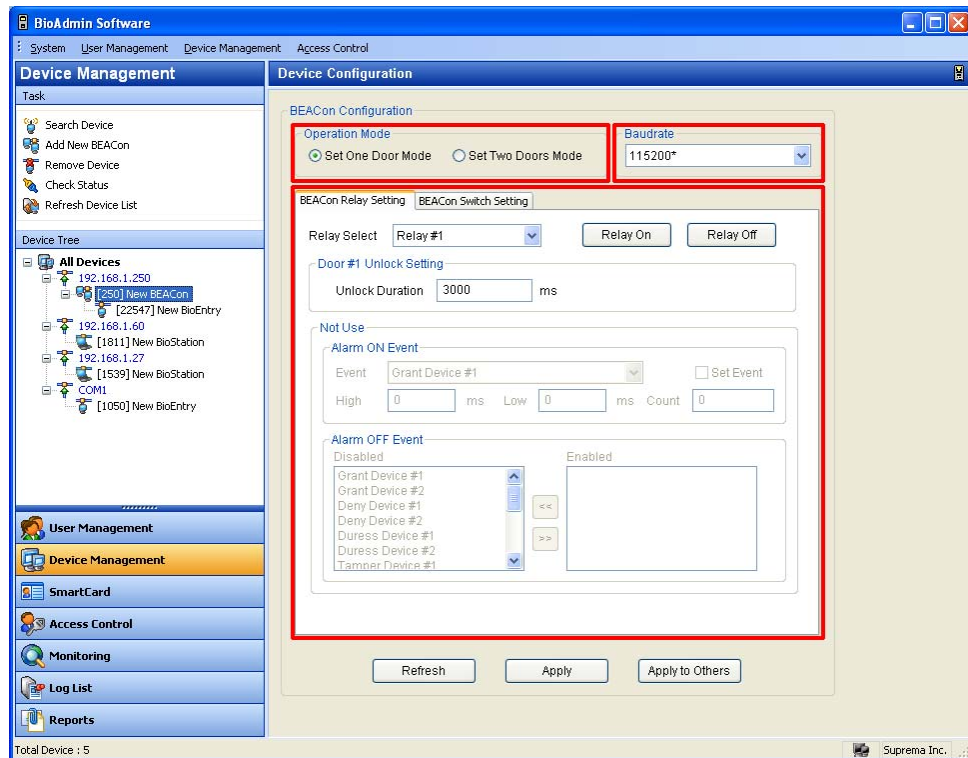

The Device Configuration window is divided into 3 sectors:

- Operation Mode

BEACon can control up to two doors. The Operation Mode window shows whether the selected BEACon is configured as one door mode or two door mode.

- Baud Rate

The Baud rate window shows the transfer speed of the selected BEACon.

- Configuration Set up window

The Configuration set up window shows the current configurations of the selected BEACon. Also, this window shows the configurations to be changed. The configuration set up menu is divided by separate tabs, such as BEACon Relay Setting and BEACon Switch Setting. For the detailed operation of BEACon, refer to BEACon operation manual.

### 5.10.1. Operation Mode

BEACon can control up to two doors. The Operation Mode window shows whether the selected BEACon™ is configured as one door mode or two door mode.

### 5.10.2. Signaling speed (Baud rate)

The Baud rate window shows the transfer speed of the selected BEACon.

- Baud rate: On this menu, you can select the transfer speed of BEACon. If you change the Baud rate on this menu, communication speed between BEACon and host PC will be changed.
- Once you change the Baud rate of BEACon, you also need to accord the Baud rate of BioEntry and BioStation with the changed Baud rate of BEACon.

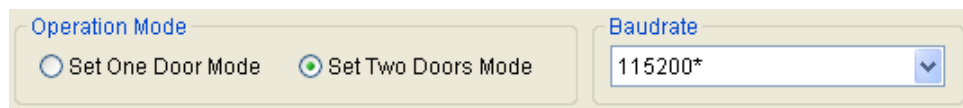

### 5.10.3. BEACon Relay Setting

On this menu, you can change the relay setting of BEACon. The relay setting can be differently configured depending on the operation mode of BEACon.

- On 1 door mode, relay #1 is automatically set up as door release. Therefore, you can set up relay #2, #3, and #4 as alarm.
- On 2 door mode, relay #1 and #2 are automatically set up as door release. Therefore, you can set up relay #3 and #4 as alarm.

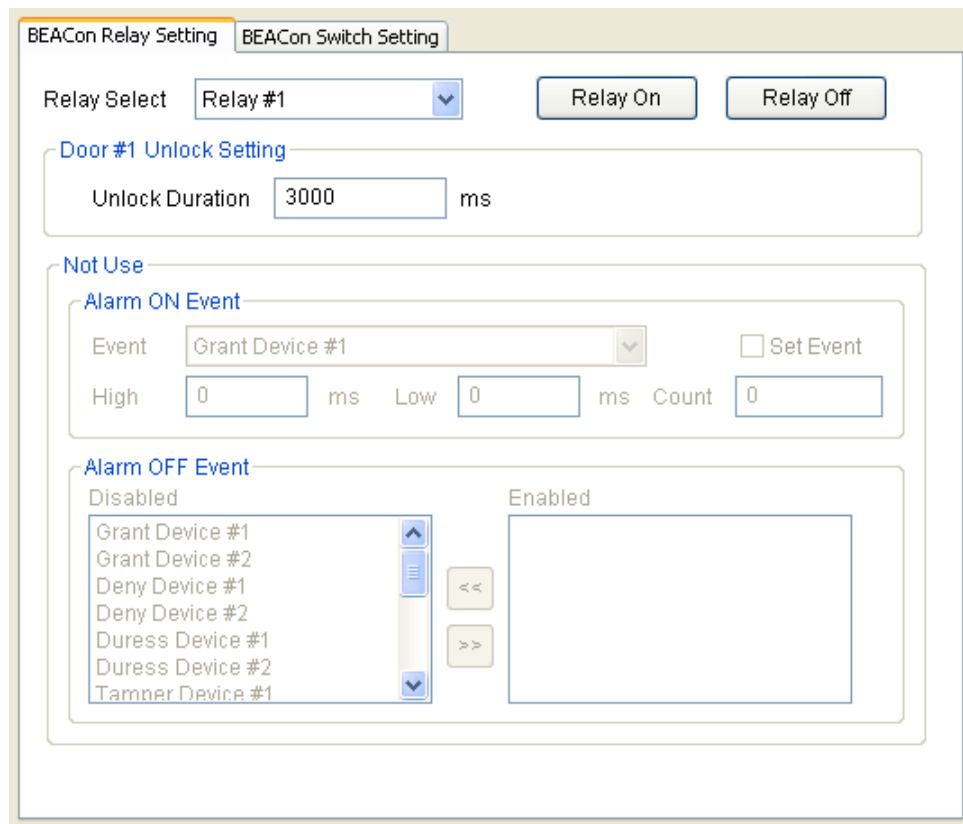

Detailed Operations are as follows.

- Select a relay to set up the configuration. Once you select a relay, applicable items for the selected relay will be activated on the relay setting window.
- You can also open/close the relays by pressing the **Relay On / Relay Off** buttons.



- **Unlock Setting**

Enter the unlock duration time. Once the door is unlocked, it can be locked again after this unlock duration time.

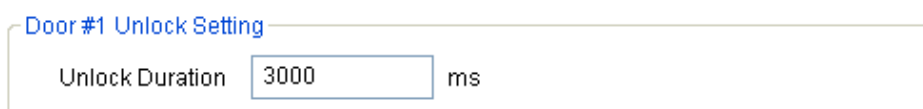

- **Alarm On Event:**

Select alarm on events on the drag down menu by checking on the **Set Event** check box. Enter **High**, **Low**, and **Count** to set up the alarm frequency. If any of the alarm on events is triggered, the alarm will be activated at your designated frequency.

Alarm ON Event

Event   Set Event

High  ms Low  ms Count

- Alarm Off Event:

Select alarm off events. You can enable the alarm off events simply by double clicking the events on the disabled event list. If any of the alarm off events is triggered, the alarm will be deactivated, regardless of remaining duration or pulse counts.

Alarm OFF Event

Disabled

Grant Device #1  
Grant Device #2  
Deny Device #1  
Deny Device #2  
Duress Device #1  
Duress Device #2  
Tamper Device #1

Enabled

<< >>

#### 5.10.4. Switch Setting

On this menu, you can change the switch setting of BEACon. The switch setting can be differently configured depending on the operation mode of BEACon.

- On 1 door mode, switch#1 is automatically set up as the door sensor and #3 as RTE (request to exit). Therefore, you can set up switch#2, #4, #5, and #6 as other various functions on the Normal Switch Setting menu.
- On 2 door mode, switch#1 and #2 are automatically set up for the door sensor. Also, switch#3 and #4 are automatically set up for RTE. Therefore, you can set up switch#5 and #6 for other various functions on the Normal Switch Setting menu.



- Select a switch to set up the configuration. Once you select a switch, applicable items for the selected switch will be activated on the switch setting window.

- Door Status Setting

By selecting a door sensor switch, you can set up the lock delay and held open delay of the connected BEACon. If the door is closed, the door strike will be locked after your designated lock delay time. If the door is opened for more than your designated Held Open Delay time, the held open door event will be triggered.

- Door RTE Setting

By selecting RTE switch, you can set up the input delay. If the RTE switch is activated for more than your designated input delay time, the door will be opened.

Door #1 RTE Setting

Input Delay  ms

- Normal Switch Setting

For the remaining switches, you can set up other various functions, such as RTE, tamper, clear alarm switch. If the switch is activated for more than your designated input delay time, the selected function will be triggered.

Normal Switch Setting

Function  

Input Delay  ms

#### 5.10.5. Refresh / Apply / Transfer (apply to another device)

- Refresh : You can restore the original configuration by pressing the **Refresh** button before pressing Apply button.
- Apply : After changing the configuration, you need to press the **Apply** button to save.
- Transfer : You can transmit the changed configurations to other devices by pressing the **Transfer** button.

## 6. Smartcard / Mifare card

The Smart Card menu is used to see the list of smartcards issued on the BioAdmin Software. All of user's smart cards will be automatically shown on the Smartcard list of this menu.

The Smartcard menu covers the following operations:

- Issue User Card
- Configure Smartcard
- Configure Card Layout
- Configure Card Wiegand
- Delete Smartcard

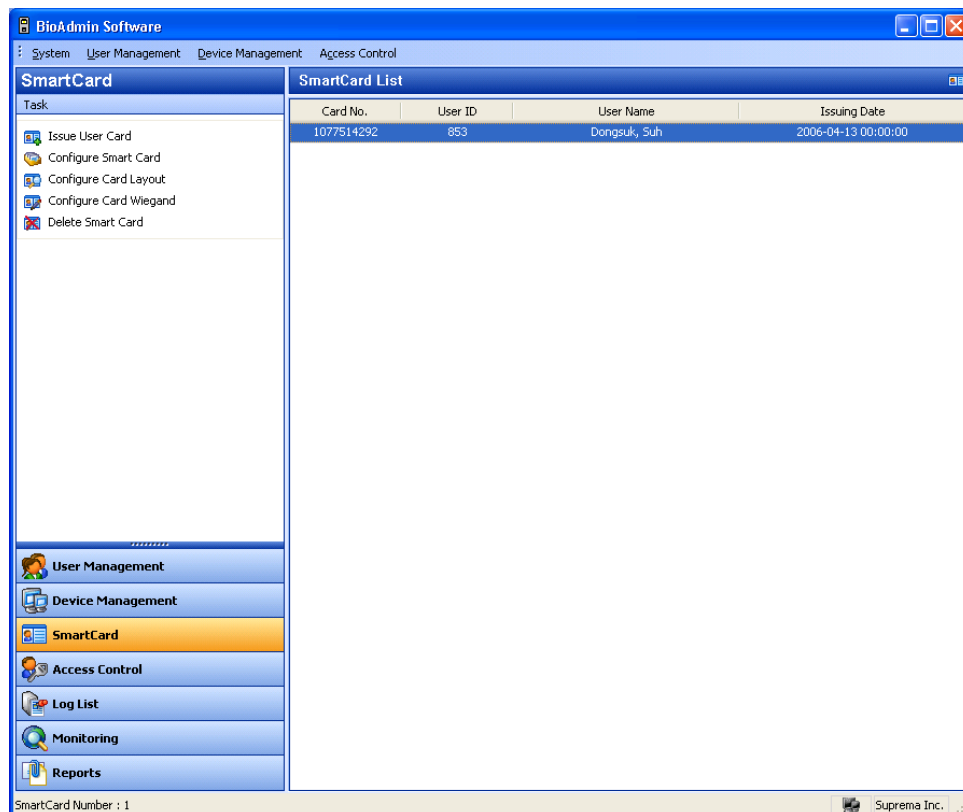

### 6.1. Configuration of Smartcard page

By selecting **Smart Card** menu, Smart Card management page is updated on the main window.

The Smartcard page is divided into 2 sectors:

- Smartcard List

The Smart card database is under central management on host PC. The Smartcard list includes the detailed list of smart cards issued on BioAdmin software.

- Task box

Task box includes buttons to control the basic operations of the Smartcard page.

## 6.2. Smartcard List

The Smartcard list includes the following information of the Smartcards.

- Card Number
- User ID
- User Name
- Issuing Date
- Expiry Date

## 6.3. Card issue

The **Issue User Card** menu enables a pop-up window to issue a user's smart card. For the detailed operation, refer to the issuing procedure on the User Management menu.

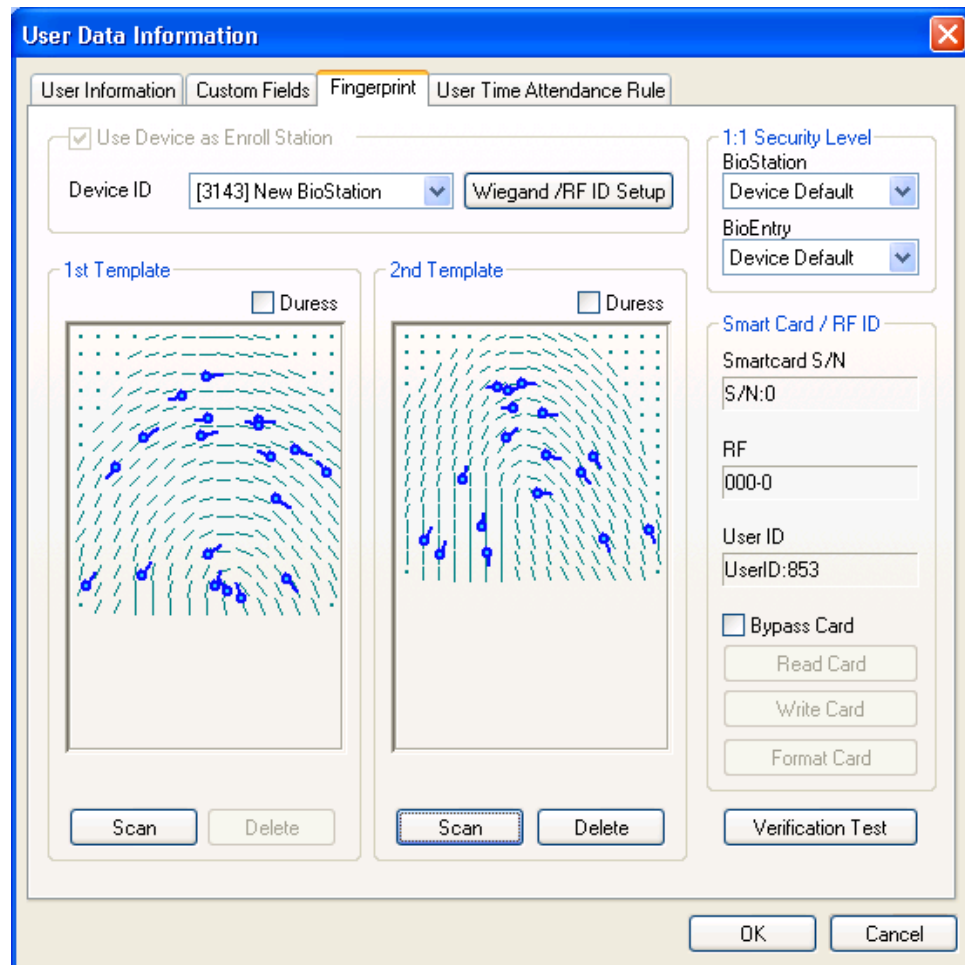

#### 6.4. Configure Smartcard

The **Manage Smartcard** menu enables a pop-up window to read the smart card information and format smart card. On this window, you can check the smartcard information such as Serial No, Wiegand string(if applicable), User ID, Security Level, User Name, Access Group, and Template Data.

If you do not have a USB smart card Device/Writer, you can also read the smart card information directly through BioEntry by check on **Use BioEntry as Enroll Station**.



The image shows a software window titled "Smartcard Info" with a close button in the top right corner. At the top, there is a checked checkbox labeled "Use BioEntry as Enroll Station". Below it is a dropdown menu for "BioEntry ID" showing "[1050] New BioEntry" and a "Read Card" button. A section titled "Smart Card Info" contains several input fields: "Serial No." (40399034), "Wiegand String" (00000000 000006at), "UserID" (853), "Security Level" (BioEntry Default), "User Name" (Dongsuk, Suh), and "Access Group" (empty dropdown). Below this are two fingerprint template preview areas, "1st Template" and "2nd Template", each showing a fingerprint with blue dots and lines. Under each preview is a "Duress" field with a "No" button. At the bottom of the window are "Format Card" and "Close" buttons.

#### 6.4.1. Read issued smart card

On this Manage Smartcard window, information stored on the smart card can be retrieved similarly to the reading process described in Chapter 4. User Management.

#### 6.4.2. Smart card format

On this Manage Smartcard window, the formatting can be processed similarly to the formatting process described in Chapter 4. User Management.

### 6.5. Edit Card Layout

Smartcard layout is the process of defining custom sectors on user's smart card to store user information including templates. By selecting the **Configure Smartcard**

**Layout** button, the smartcard layout page is updated on the main window. It is recommended that only advanced users attempt to change the layout since improper changes may render the smart card unusable. Read this chapter carefully for changing the layout from the default configuration.

#### 6.5.1. Select Device Type for Smart card / Mifare card

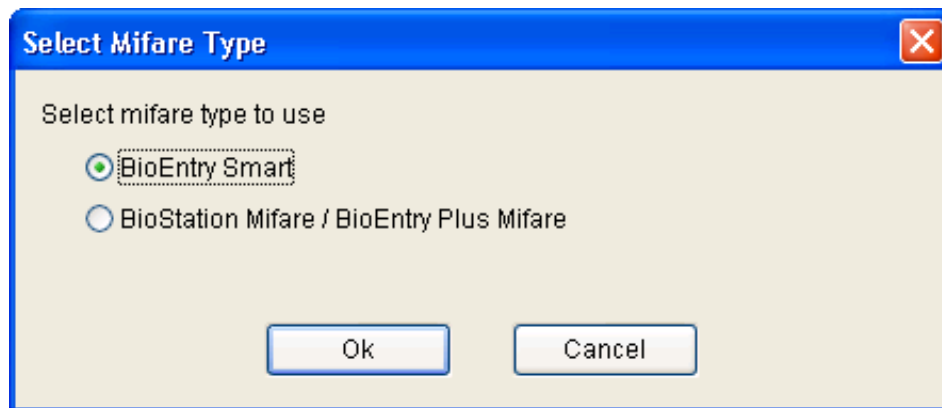

Select the type to edit layout, which is not related with 'Mifare Card Type" (System - > Preference), but just select a type.

#### 6.5.2. Configuration of smartcard layout edit page (BioEntry Smart Only)

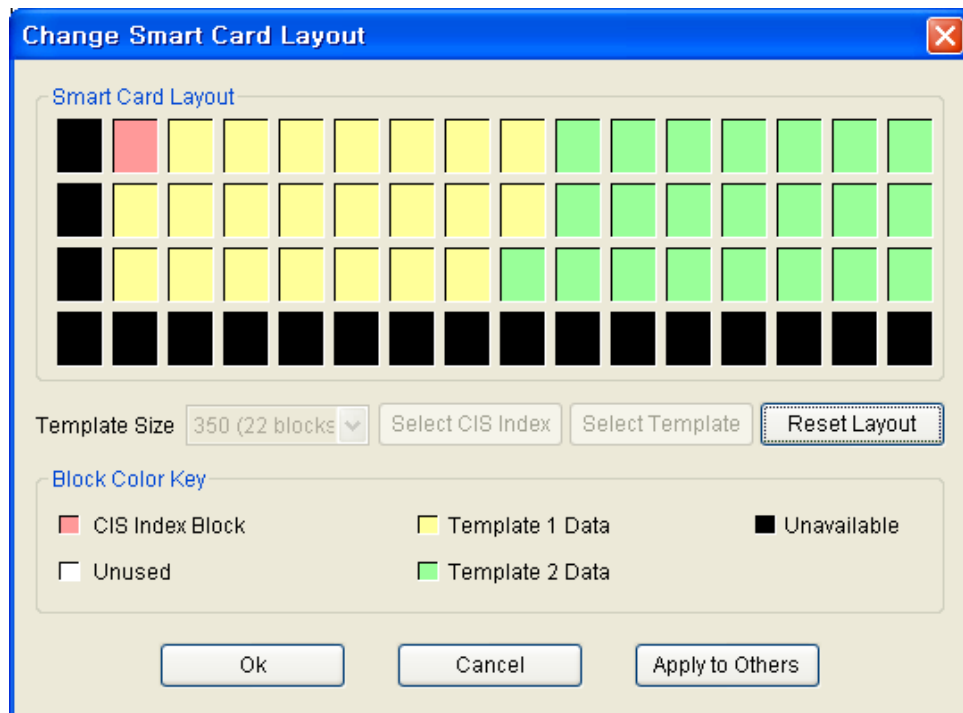

The Configure Smartcard layout page is divided into 3 sectors :

- Smart Card Layout

It shows the smartcard layout of the Smartcard Device/Writer device connected to the host PC.

- Smart Card Layout

It shows the name of currently selected device and the layout of the current device. If a group or all devices are selected, the contents are not available.

- New configuration

This sector is used for editing new layout to be applied to the devices and the user's smart card.

- Controls for managing layout

**Fill with Current Configuration Value** button updates the contents of the new configuration using the retrieved layout from currently selected device. **Transfer** button transmits new layout to the selected BioEntry™ device, selected group, or all BioEntry™ devices. Several control buttons for editing layout also exist.

### 6.5.3. Size of Fingerprint data (Template)

Template size is configurable from 254 to 382. By factory default, template size is



specified as 350 bytes storing two templates on the card.

#### 6.5.4. Block

- CIS index block : The header information is stored on the CIS index block which is depicted by red color.
- Template data block : Blocks for template 1 data and template 2 data. The number of blocks for each template data is determined by template size. Template 1 data is depicted by yellow and template 2 data is depicted by green, respectively.
- Unused block : Blank block which is not defined by layout.
- Unavailable block : Block that is prohibited from use.

#### 6.5.5. Editing process

To configure customer's layout, the following procedure is required.

- Initialize all the blocks to unused ones by pressing the **Reset Layout** button.
- Select the required template size.
- Press the **Select CIS Index** button and click an unused block to select a CIS index block.
- Press the **Select Template** button and click an unused block to indicate the start block of template data. Then, the blocks of template 1 data are set automatically from the selected start block.
- Press the **Select Template** button again and click an unused block to indicate the start block of template 2 data.
- Press the **Transfer** button to transfer the new smart card layout to selected devices.

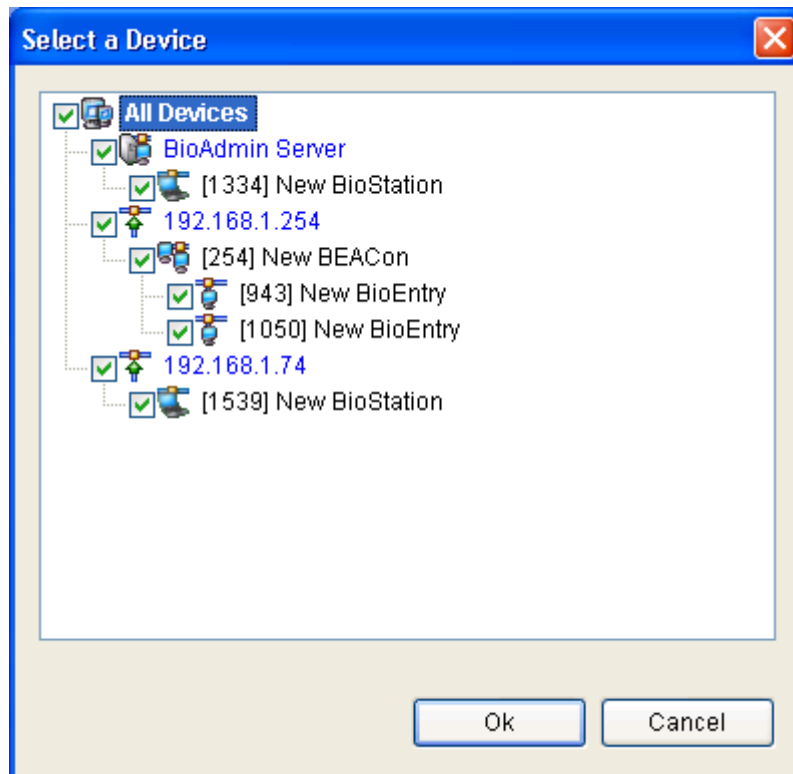

- The smart card layout window is activated only for BioEntry™ Smart model. If the selected device is BioEntry™ Pass, this menu will not be activated.
- Press the **OK** button to save the new smartcard layout to the PC USB smartcard device/writer.
- The saved layout is also applied in issuing a new smartcard using PC USB smartcard device/writer.

6.5.6. Factory default (initial setting) layout

Factory default smart card layout is as follows :

0	4	8	12	16	20	24	28	32	36	40	44	48	52	56	60
1	5	9	13	17	21	25	29	33	37	41	45	49	53	57	61
2	6	10	14	18	22	26	30	34	38	42	46	50	54	58	62
3	7	11	15	19	23	27	31	35	39	43	47	51	55	59	63

CIS Index     
  Template 1 Data     
  Unavailable  
 Unused     
  Template 2 Data

### 6.5.7. Configuration of Mifare card layout edit page (BioStation / BioEntry Plus)

It is designed to be typed numerical value (not block) to support 4K card.

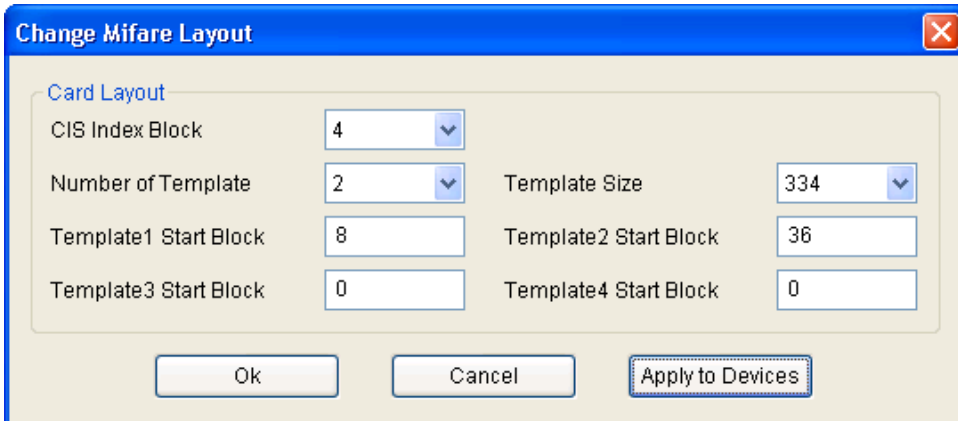

Change Mifare Layout			
Card Layout			
CIS Index Block	4		
Number of Template	2	Template Size	334
Template1 Start Block	8	Template2 Start Block	36
Template3 Start Block	0	Template4 Start Block	0
Ok      Cancel      Apply to Devices			

- CIS Index Block
- Number of Template
- Template Size
- Template1 ~ 4 Start Block
- In case of using Mifare card as CIS Only Mode, it does not use above layout though it is configured card layout.

### 6.5.8. Editing process

To configure customer's layout, the following procedure is required.

- Select the CIS Index block.
- Select the required template size.
- Select the number of templates.
- Press the Apply to Devices button to transfer the current Mifare card layout to selected devices.

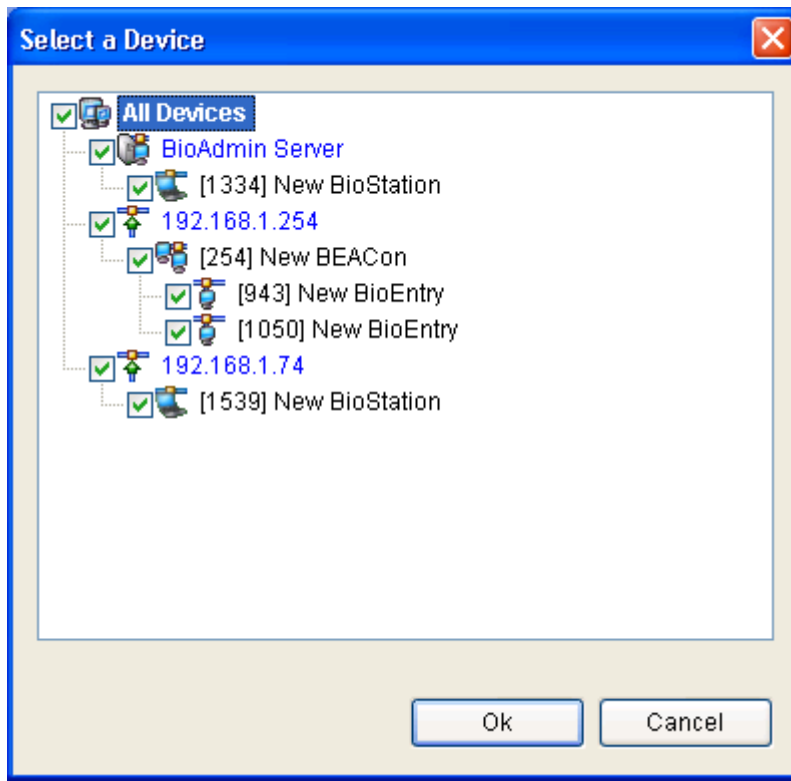

- The Mifare card layout window is activated only for BioStation™ Mifare or BioEntry Plus™ Mifare model.
- Press the OK button to save the new Mifare card layout to the PC USB smartcard device/writer.
- The saved layout is also applied in issuing a new smartcard using PC USB smartcard device/writer.

## 7. Access Control

In the menu, time span and access group may be designated. Time span and access group are used to limit user's authority to allow their access according to the rules.

Although up to BioAdmin 4.1 version, the access control may be used as it is, new access control function may be also used easily. However, to use the new access control function, the existing setting is disabled; if a user is to use the new access control function with the previous items, it is possible to select which function is to be used. If the selection is changed, BioAdmin Client should be resumed; if using the existing one, a user does not need resuming.

- If a user is not included in any access group, it is allowed to enter every entry door. However, if a user is set to any basic access group, the user should follow the basic entry group setting.
- If a user is contained in a group but the does not have the information about the access, the user may access the door with no restriction. However, if using a new access group function, the device must have the group information.

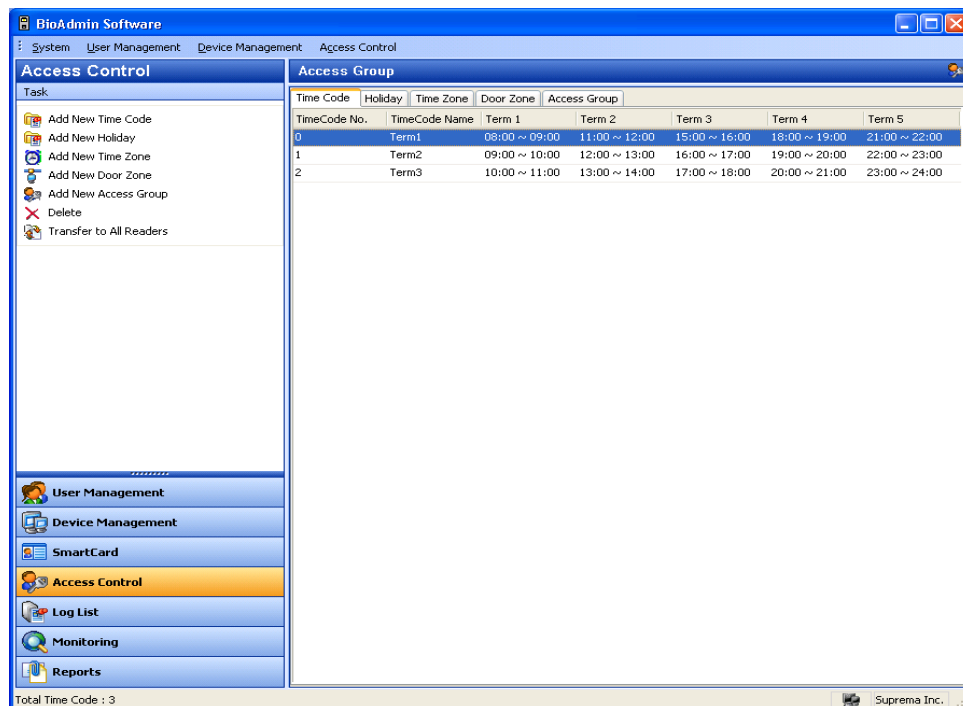

## 7.1. Time Code setting

You can set up Time Zone by combining several Time Codes. Therefore, before setting up the time zone, you need to set up the time code first. Maximum 5 time sections can be selected for each time code.

Detailed operations are as follows.

- Press the **Add New Time Code** button.

**Time Code Definition**

Time Code Name:

Time Code

Term 1	<input type="text" value="10"/>	:	<input type="text" value="30"/>	to	<input type="text" value="11"/>	:	<input type="text" value="50"/>	<input type="button" value="Type directly"/>
Term 2	<input type="text" value="13"/>	:	<input type="text" value="40"/>	to	<input type="text" value="13"/>	:	<input type="text" value="50"/>	<input type="button" value="Clear Table"/>
Term 3	<input type="text" value="16"/>	:	<input type="text" value="30"/>	to	<input type="text" value="19"/>	:	<input type="text" value="00"/>	
Term 4	<input type="text" value="00"/>	:	<input type="text" value="00"/>	to	<input type="text" value="00"/>	:	<input type="text" value="00"/>	
Term 5	<input type="text" value="00"/>	:	<input type="text" value="00"/>	to	<input type="text" value="00"/>	:	<input type="text" value="00"/>	

0 1 2 3 4 5 6 7 8 9 10 11 12 13 14 15 16 17 18 19 20 21 22 23 24

- Input the name of time span.
- Input the time in a box and set the time code.
- Time span may be easily set by dragging the time bar displayed on the bottom. Time code is also set by dragging it to the bottom of Window.
- If directly entering time, click 'Direct Input' button.
- In case directly inputting the time, each space is changed to be entered.
- If completing the entries, press 'Apply' to save them.
- If directly entering and dragging the timer bar on the bottom, the set values are changed into the contents in the selected time bar. In addition, please note that all other times shorter than 10 minutes, it is changed to 0 or 10 minutes.
- Click **OK** button to add time span to the list of time span.

## 7.2. Holiday setting

To include holidays on the Time Zone, you need to set up holidays in advance.

Detailed operations are as follows.

- Press the **Add New Holiday** button.
- Press the **Edit Code list in Holiday Setting** window.

The screenshot shows a 'Holiday Setting' dialog box. At the top, the title bar says 'Holiday Setting' with a close button. Below the title bar, there is a text field labeled 'Name' containing 'New Holiday List'. Underneath is a list box containing one item: '10/19/2007(4)'. To the right of the list box are two buttons: 'Del' and 'Del All'. Below the list box is a date selection field showing 'Friday , October 19, 2007' and an 'Add' button. Underneath is a checkbox for 'Yealy Repeat' (unchecked), a spinner box with the value '4', and the text 'Days Long'. At the bottom are 'OK' and 'Cancel' buttons.

- Enter the name of Holiday Group.
- Enter the date to be grouped as a holiday group and click **Add** button.
- At the moment, it is also possible to designate period or repeat, depending on the date option.
- Enter the number of days to enter. However, the max. number of items may not be larger than 32. In the case, holiday group should be additionally created.

- After completing the addition of holiday, click **OK** button.
- The generated Holiday list can be used for Time & Attendance Report.

**T&A Rule Group**

Name: New T&A rule group(2)

**Daily Rule**

Sunday: New Attendance Code

Monday: New Attendance Code

Tuesday: New Attendance Code

Wednesday: New Attendance Code

Thursday: New Attendance Code

Friday: New Attendance Code

Saturday: New Attendance Code

**Holiday Setting**

Holiday Schedule: New Attendance Code

Holiday Group1: New Holiday List

Holiday Group2: Not Use

Monthly Schedule: New monthly schedule

Set as default

Save Close

### 7.3. Time zone setting

You can set up a Time Zone by combining time codes and a holiday group. One time code is selected for each day from Monday to Sunday.

Detailed operations are as follows.



- Press **Access time setting** button.
- Enter the name of access time.

- Select time span per day of the week from Monday to Sunday.
- Select holiday group.
- Select the time span to apply for holiday group.
- Holiday group may be set in two ways.
- To add the set access time to list of access time, click **OK** button.
- 

#### 7.4. Door Zone setting

From BioAdmin v4.2, new type of Access Control is used.

- v4.1 below : Please use previous format
- New User : Please use v4.2 only format

If previous user having BioAdmin v4.1 below, it is possible to convert to v4.2 only format, but won't back to previous format any more.

Please pay attention to your decision, which will be asked warning message whether it will convert to new Access Control format or not.

You can set up a door zone combining multiple BioEntry™ devices.

- Enter the name of the door zone.
- Check on the target BioEntry™ devices and click the << button.

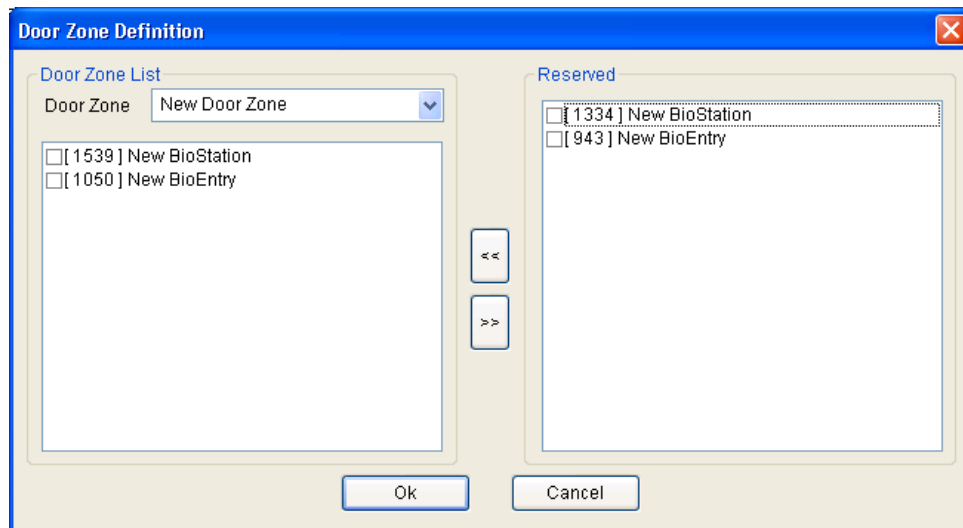

- Press the **OK** button to add the door zone on the door zone list.

## 7.5. Access Group setting

As you seen in “6.4 Door Zone Setting”, there are previous and new method for access group setting.

[Previous Method]

By combining time zone and door zone, you can designate an access group. With this access group, you can restrict the user's right to access.

- Press the **Add New Access Group** button.
- Enter the name of access group.
- Check on the time zone and door zone and press the << button.

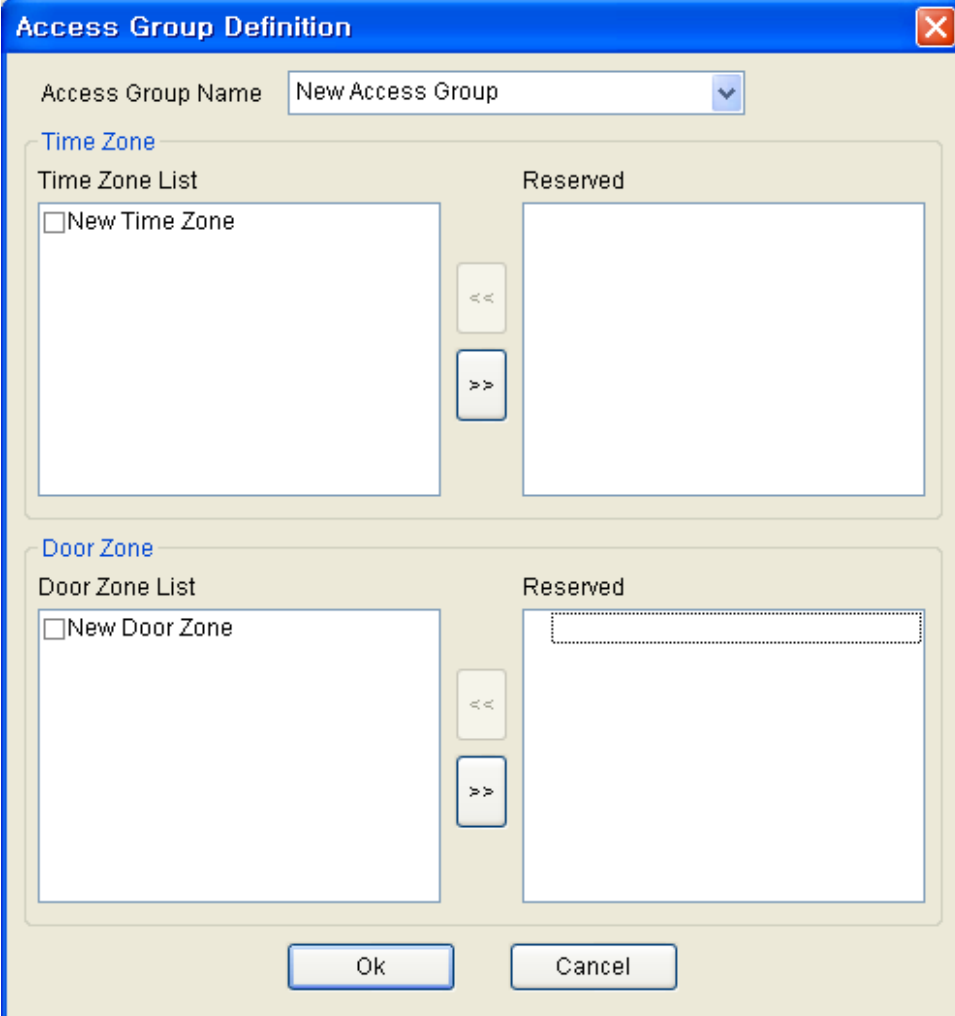

The image shows a dialog box titled "Access Group Definition" with a blue title bar and a close button (X) in the top right corner. The dialog is divided into two main sections: "Time Zone" and "Door Zone".

**Access Group Name:** A dropdown menu currently showing "New Access Group".

**Time Zone Section:**

- Time Zone List:** A list box containing one item:  New Time Zone.
- Reserved:** An empty list box.
- Navigation:** Two buttons between the lists: a left arrow button (←) and a right arrow button (→).

**Door Zone Section:**

- Door Zone List:** A list box containing one item:  New Door Zone.
- Reserved:** A list box with a dashed rectangular outline at the top, indicating a reserved space.
- Navigation:** Two buttons between the lists: a left arrow button (←) and a right arrow button (→).

**Buttons:** At the bottom of the dialog are two buttons: "Ok" and "Cancel".

- Press the **OK** button to add the selected access group to the access group list. You can apply this access group to users on the 4. User Management menu.
- New Method

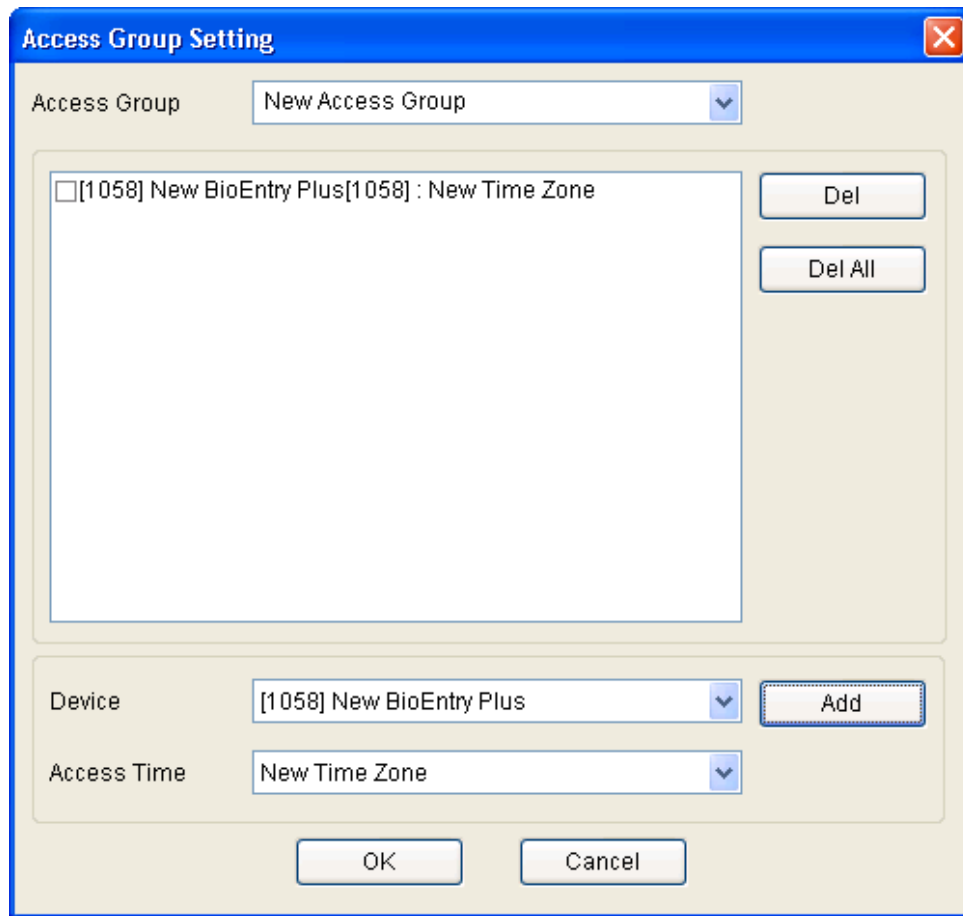

- To start with BioAdmin v4.2 only, please follow the direction.
- Select a device and add or delete 'Time Zone' of device.
- For special user in specific time, select device and change 'Default Access Group' to Full Access.
- Go to 'Add New Time Zone' and make access time for a special user.

**User Data Information**

User Information | Custom Fields | Fingerprint | User Time Attendance Rule

**Basic Personal Information**

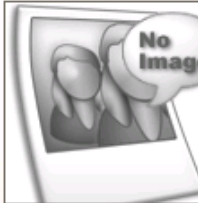
 User ID: 853

Name: Dongsuk, Suh

Company: Suprema

Department: R&D

Title: Manager

**Details**

Phone: 012-345-6789

Mobile: 098-765-4321

E-Mail: dsuck@anymail

Gender: Male

Date of Birth: 6/14/1970

Start Date: 1/ 1/1970

Expiry Date: 12/30/2030 0 h

**Access Group**

Status:  Active

Group 1: Full Access

Group 2: None

Group 3: Full Access

Group 4: No Access

**Entrance Limitation (BioStation)**

Daily Limit: 0 (0:00~23:59)

Timed APB: 0 Minute

**Other Information**

Password:

BST Admin Level: Normal User

## 8. Monitoring

BioAdmin supports real time monitoring functions. By selecting the **Monitoring** menu, you can check the log events of networked BioEntry and BioStation on time.

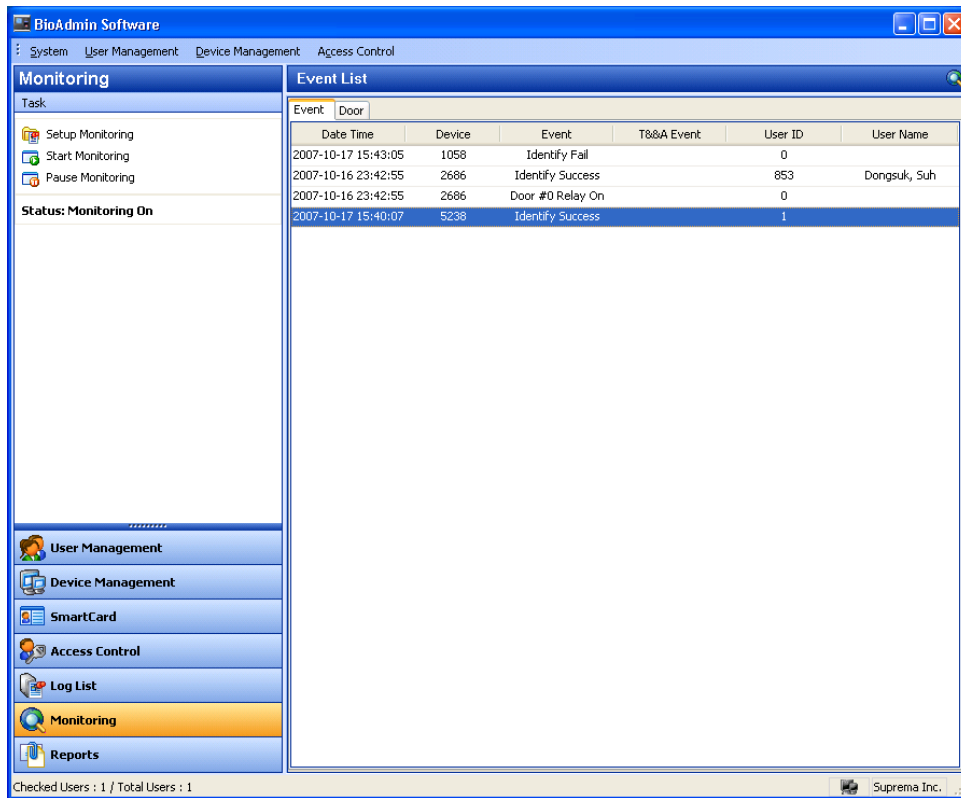

The screenshot shows the BioAdmin Software interface. The main window is titled "BioAdmin Software" and has a menu bar with "System", "User Management", "Device Management", and "Access Control". The left sidebar contains a "Monitoring" section with a "Task" list: "Setup Monitoring", "Start Monitoring", and "Pause Monitoring". Below this, the status is "Monitoring On". The bottom sidebar contains a navigation menu with "User Management", "Device Management", "SmartCard", "Access Control", "Log List", "Monitoring" (highlighted), and "Reports". The main content area is split into two panels: "Monitoring" and "Event List". The "Event List" panel displays a table with the following data:

Date Time	Device	Event	T&A Event	User ID	User Name
2007-10-17 15:43:05	1058	Identify Fail		0	
2007-10-16 23:42:55	2686	Identify Success		853	Dongsuk, Suh
2007-10-16 23:42:55	2686	Door #0 Relay On		0	
2007-10-17 15:40:07	5238	Identify Success		1	

At the bottom of the window, it shows "Checked Users : 1 / Total Users : 1" and the "Suprema Inc." logo.

### 8.1. Setup Monitoring

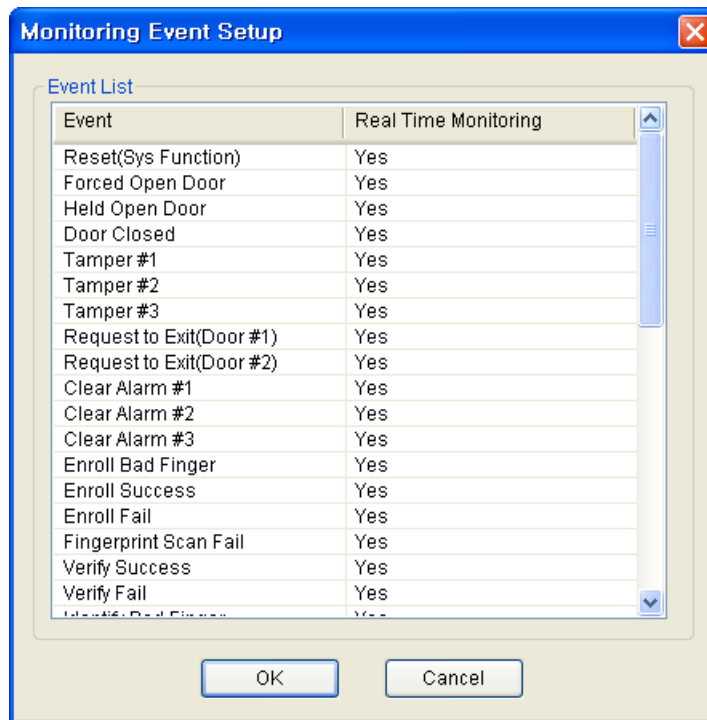

On this menu, you can select the events to be shown on the monitoring window simply by double clicking on the Yes/No field of each event.

- If you double click the Yes field, it will be changed to No, and the event will not be listed on the monitoring window.
- If you double click the No field, it will be changed to Yes and the event will be listed on the monitoring window.

## 8.2. Start Monitoring

- By pressing the **Start Monitoring** button, you can start the real time monitoring of the log events from all networked BioEntry and BioStation.
- If you select another menu during monitoring mode, monitoring will be stopped.
- Event List on the monitoring window shows up to 5000 events. If the number of events is more than 5000, the oldest event will be automatically deleted from the list. Even though the oldest event is deleted from the monitoring list, it still remains on the log data of BioEntry and BioStation.

Monitoring is automatically started when the menu **Monitoring** is selected from another menu. So, the **Start Monitoring** is needed only to restart

monitoring after pausing monitoring.

### 8.3. Pause Monitoring

By pressing the **Pause Monitoring** menu, you can stop monitoring.

### 8.4. Event List for Door

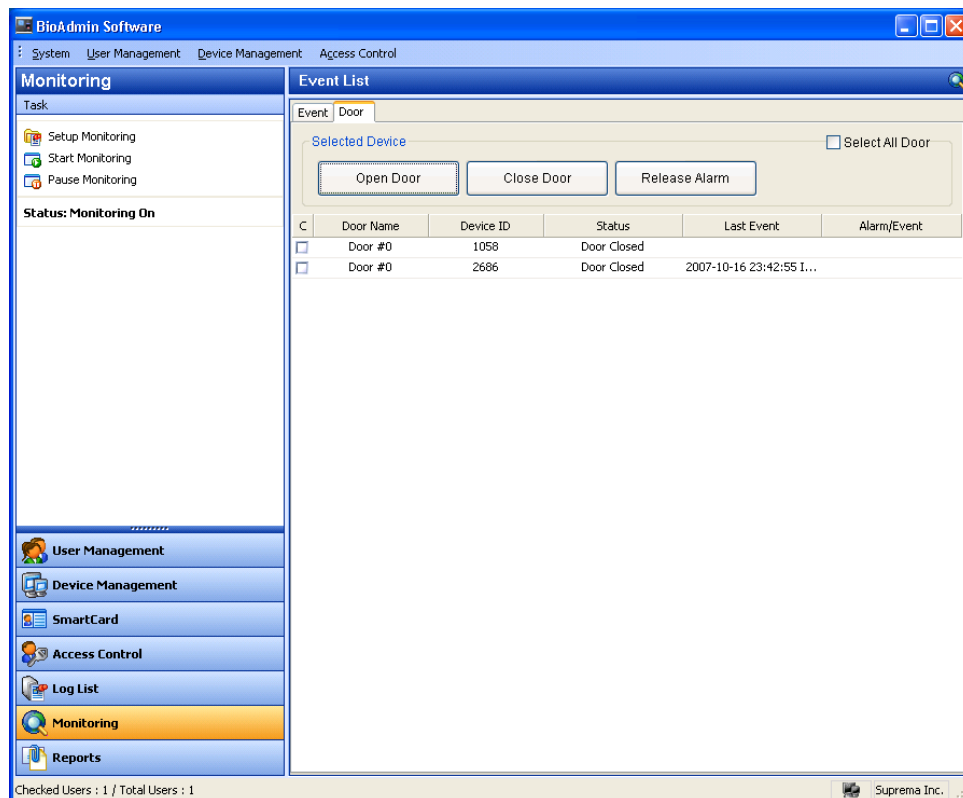

It supports the status of access door. Selecting real time monitoring and selecting 'Access door' shows the monitoring screen of access door.

#### 8.4.1. Door Open/Close

- If checking the checkbox of access door to open from the access door list and click 'Door Open', you may open or close the door.
- However, in the case, it analyze it only with input information, unlike the determination whether it is closed, so it may differ from the actual status.



#### 8.4.2. Alarm Release

- If there is an event to generate an alarm to open door or forcibly open door, the alarm status may be canceled by clicking 'alarm release.'
- However, alarm release may require the operation of admin.

## 9. Log List

The Reports menu covers the following operations:

- Management of log database stored on host PC
- Upload new log events from BioEntry and BioStation into the log database

By selecting the Log List, the log list page is updated on the main window.

Date Time	Device ID	Event	T&A Event	User ID	User Name	Source
2007-02-28 11:31:05	1334	Enroll Success		2		BioStation
2007-02-28 11:31:06	1334	Enroll Success		3		BioStation
2007-02-28 11:31:07	1334	Enroll Success		853	Dongsuk, Suh	BioStation
2007-02-28 11:31:08	1334	Enroll Success		861	Nakwon, Lee	BioStation
2007-02-28 11:31:09	1334	Enroll Success		934	ChangGyun, Lee	BioStation
2007-02-28 11:36:26	1334	Identify Mode...		1		BioStation
2007-02-28 12:00:51	1334	Delete Success		1		BioStation
2007-02-28 12:00:51	1334	Delete Success		2		BioStation
2007-02-28 12:00:52	1334	Delete Success		3		BioStation
2007-02-28 12:00:52	1334	Delete Success		853	Dongsuk, Suh	BioStation
2007-02-28 12:00:53	1334	Delete Success		861	Nakwon, Lee	BioStation
2007-02-28 12:00:53	1334	Delete Success		934	ChangGyun, Lee	BioStation
2007-02-28 12:01:05	1334	Delete All		0		BioStation
2007-02-28 12:01:41	1334	Delete All		0		BioStation
2007-02-28 12:01:57	1334	Enroll Success		1		BioStation
2007-02-28 12:01:58	1334	Enroll Success		2		BioStation
2007-02-28 12:02:00	1334	Enroll Success		3		BioStation
2007-02-28 12:02:01	1334	Enroll Success		853	Dongsuk, Suh	BioStation
2007-02-28 12:02:02	1334	Enroll Success		861	Nakwon, Lee	BioStation
2007-02-28 12:02:03	1334	Enroll Success		934	ChangGyun, Lee	BioStation
2007-02-28 12:02:13	1334	Enroll Success		1		BioStation
2007-02-28 12:02:14	1334	Enroll Success		2		BioStation
2007-02-28 12:02:15	1334	Enroll Success		3		BioStation
2007-02-28 12:02:16	1334	Enroll Success		853	Dongsuk, Suh	BioStation
2007-02-28 12:02:17	1334	Enroll Success		861	Nakwon, Lee	BioStation
2007-02-28 12:02:18	1334	Enroll Success		934	ChangGyun, Lee	BioStation
2007-02-28 15:37:19	1334	System Started		0		BioStation
2007-02-28 20:23:19	1334	System Started		0		BioStation
2007-02-28 21:21:05	1334	Delete All		0		BioStation
2007-02-28 22:04:59	1334	Identify Fail		0		BioStation
2007-02-28 22:05:07	1334	Identify Fail		0		BioStation
2007-02-28 22:05:41	1334	System Started		0		BioStation

### 9.1. Configuration of Log check page

The Reports page is composed of 2 components:

- Log List
 

Log database is stored on host PC enabling to preserve old log data. Log list shows stored log events describing Date, Time, Device ID, Event, User ID, User Name, and Source.
- Filtering Tool
 

You can filter log records by Date, Device, User ID, Name, Event, and Source. For example, if a device is selected, log events of the selected device will be

shown.

- Task box

Task box includes buttons to control basic operations of the Log List page.

## 9.2. Manage Log database

### 9.2.1. Get recent logs

In case of pressing **get recent logs/ auto upload** button, window for select device pops up and as to selected device here, log information newly generated after log information in BioAdmin is uploaded.

For the BioStation connected to BioAdmin Server, you do not need to get logs from them, because logs will be automatically saved on BioAdmin Server on real time.

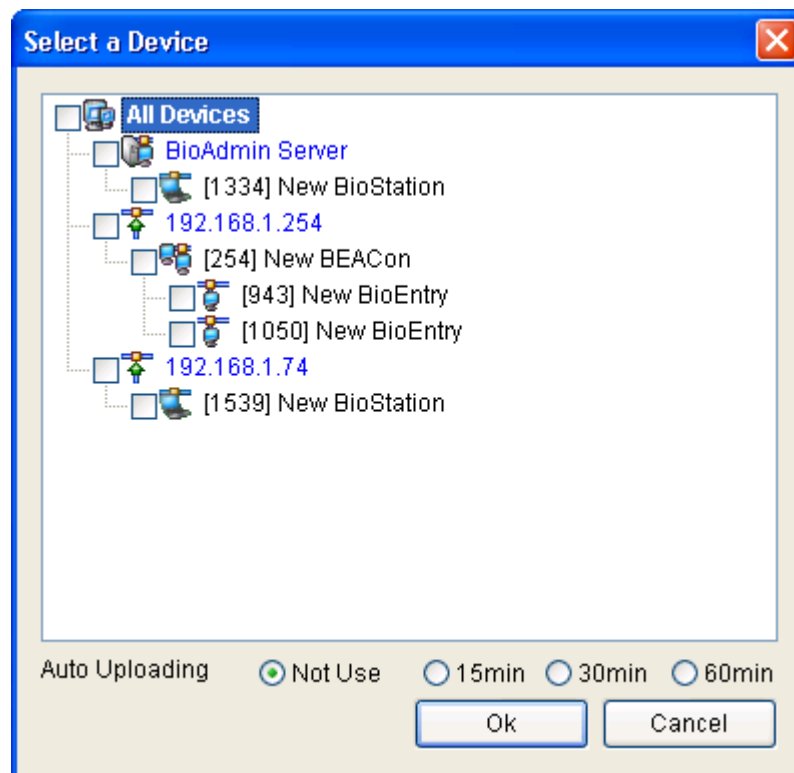

### 9.2.2. Auto uploading setting

In case of pressing **get recent logs/ auto upload** button, log information generated in BioEntry and BioStation for set period can be uploaded automatically to BioAdmin. Administrator can execute auto uploading by choosing 15 min / 30

min / 60 min according to applied environment.

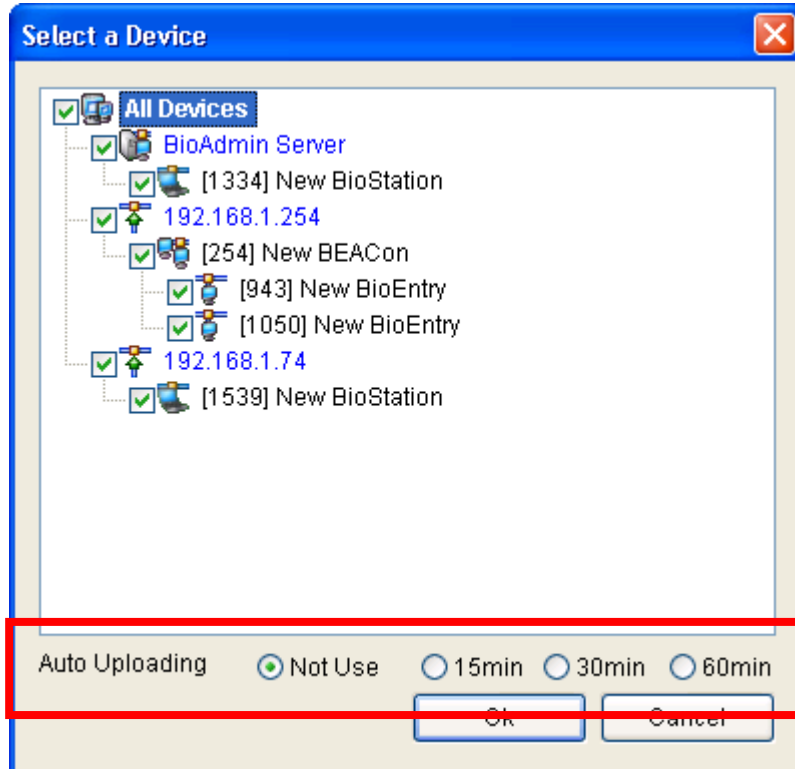

Once auto uploading is applied, **status : auto uploading on** is indicated on task box.

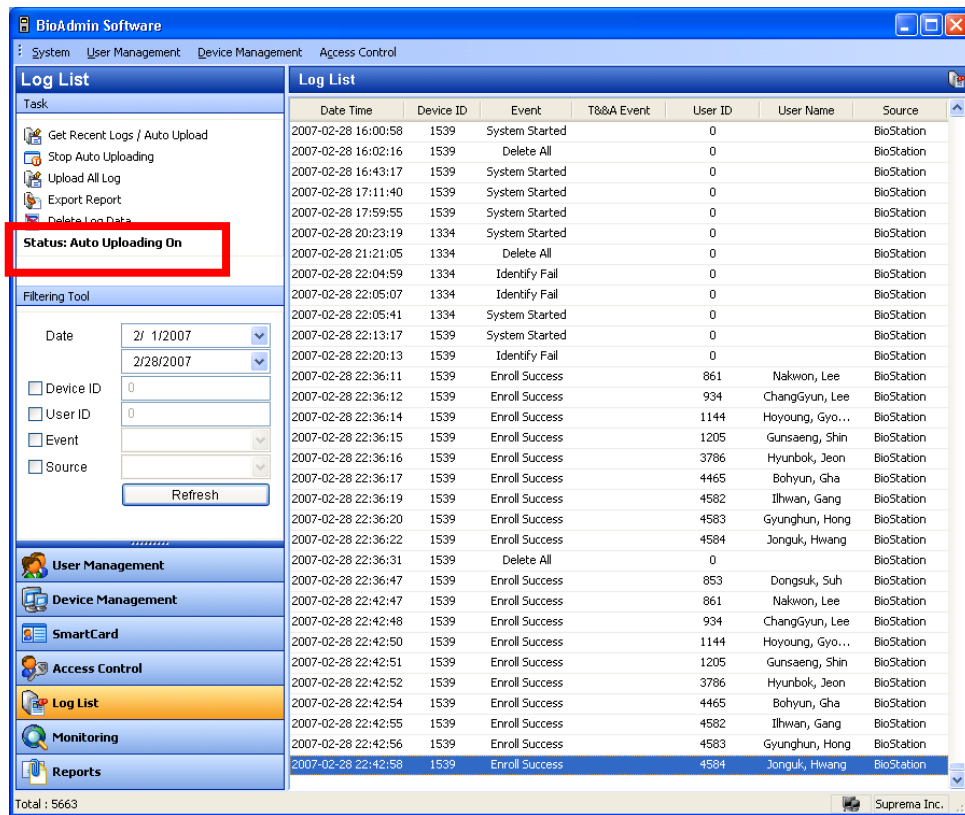

### 9.2.3. Release auto uploading

In case of pressing **stop auto uploading** button, user can release set auto uploading. Also, in case of disabled mode when setting time transfer, user can release time transfer.

Once auto uploading is released, **status : auto uploading off** is indicated on task box

The screenshot displays the BioAdmin Software interface. On the left, there is a 'Task' list with options: 'Get Recent Logs / Auto Upload', 'Stop Auto Uploading', 'Upload All Log', 'Export Report', and 'Delete Log Data'. A red box highlights the 'Status: Auto Uploading Off' button. Below the tasks is a 'Filtering Tool' with a 'Date' dropdown set to '2/ 1/2007' and '2/28/2007', and checkboxes for 'Device ID', 'User ID', 'Event', and 'Source'. A 'Refresh' button is also present. The main area is a 'Log List' table with the following columns: Date Time, Device ID, Event, T&A Event, User ID, User Name, and Source. The table contains multiple rows of log entries, including 'System Started', 'Delete All', and 'Enroll Success' events. At the bottom left, it says 'Total: 5663' and at the bottom right, 'Suprema Inc.' is visible.

#### 9.2.4. Upload all logs

In case of pressing **upload all logs** button, select device window appears and all logs of device selected here are uploaded. In case partial log information remains in BioAdmin, existing log information is kept as it is and new log information is uploaded.

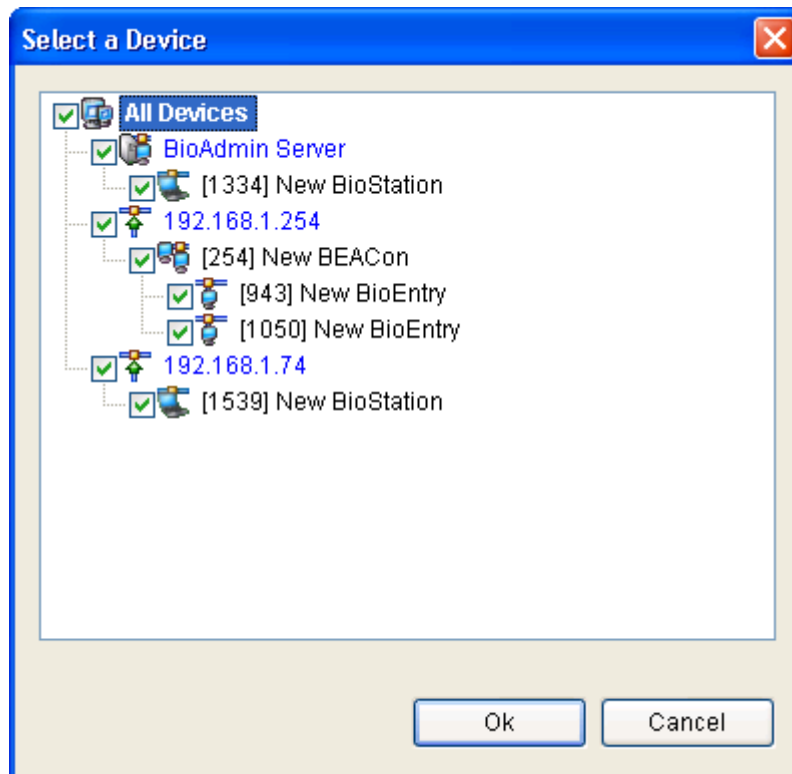

### 9.2.5. Export Report

Log data can be exported to CSV file format using the **Export Report** button.

Detailed operations are as follows:

- Press the **Export Report** button.
- Select fields to export by simply moving the target field from Field List to Selected Field List.

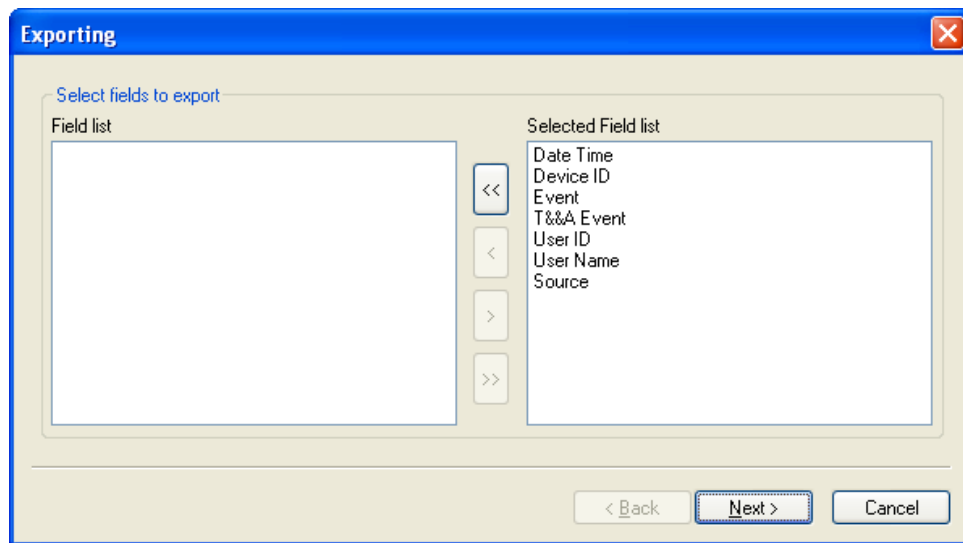

- After selecting the fields, press the **Next** button.
- Select a file to export
- After selecting the file, press the **Next** button.
- Press the **Export** button.

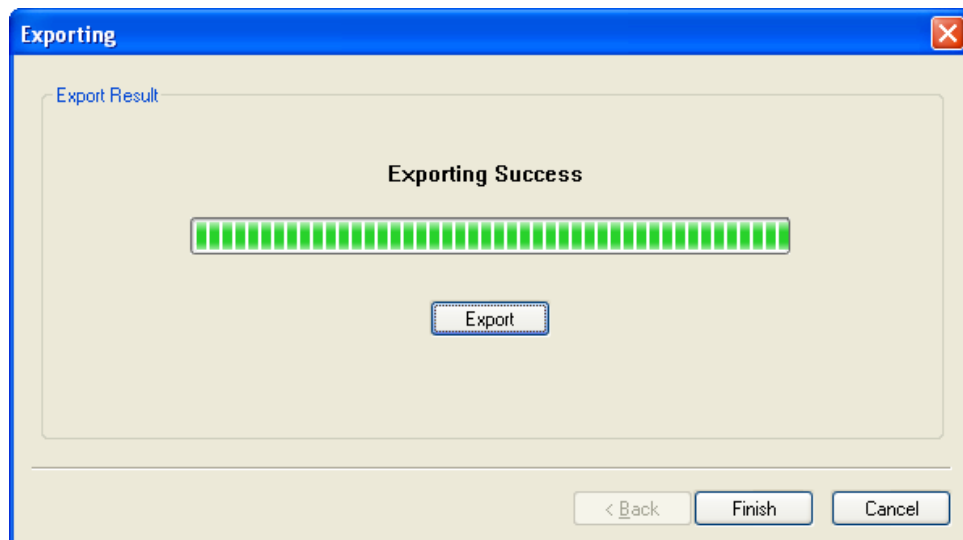

#### 9.2.6. Delete Log information

The **Delete Log Data** button eliminates selected log data from log database on host PC. Log data on BioEntry and BioStation are not removed by this command, but automatically removed only when the device requires space for additional log data.



## 10. Reports

Report menu includes the followings operations.

- Set up attendance rule
- Upload log from device and create T&A event report.
- Export a created report to file
- Print created report

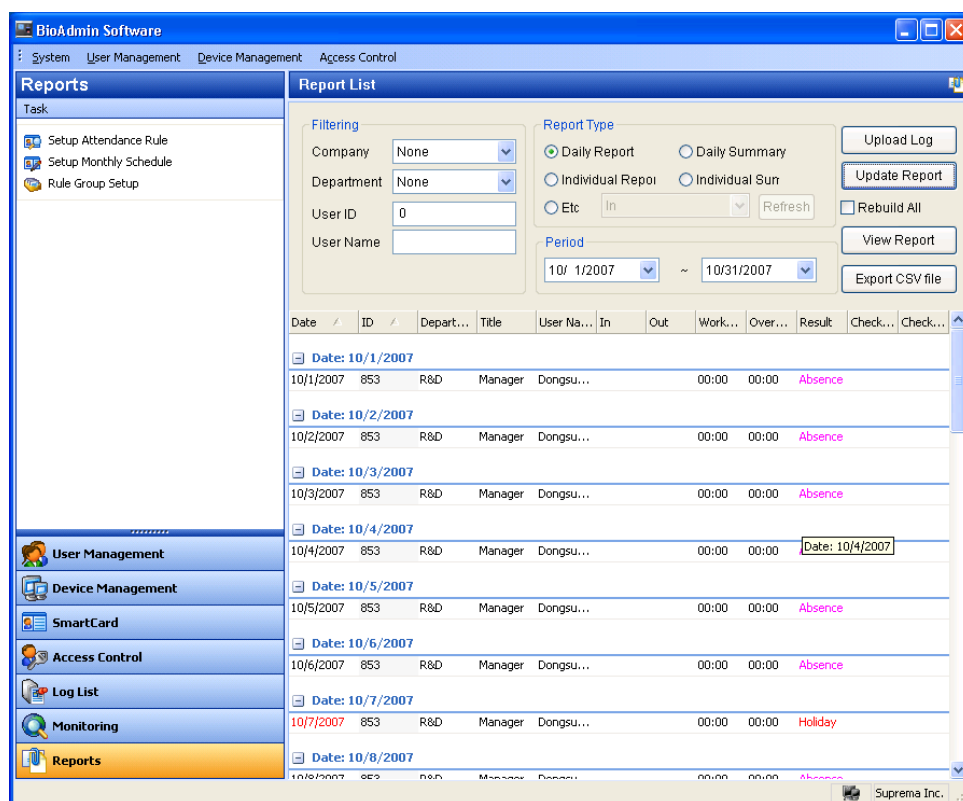

### 10.1. Configuration of reports page

Report list page consists of 2 elements:

- Report list page
  - Report list shows menus setting filtering, report type, period and basic information required for creating a report.
- Task box
  - Task box has buttons to set T&A rule.



- Enter attendance code.

### 10.2.1. Device setup

Select device setup menu on time attendance rule page and set In/Out input device as below.

The screenshot shows a window titled "Time/Attendance Code Definition" with a close button in the top right corner. Inside the window, there is a tabbed interface with "Device Setup" and "Time Setup" tabs. The "Attendance Code" field is set to "New Attendance Code". Under the "Reader Setup" section, three radio buttons are present: "First Check-In / Last Check-Out" (selected), "Separate Check-In/Check-Out Devices", and "Using Function Keys (BioStation)". Below this is the "Select Device" section, which has two radio buttons: "Use All Devices to collect attendance data" (selected) and "Use Selected Device to collect attendance data". There are two empty text input boxes, one with a "Select Device" button to its right and another with a "Select Check-Out Device" button to its right. At the bottom of the "Select Device" section is a checkbox labeled "Calculate work time from in-time to out-time only", which is currently unchecked. At the very bottom of the window are "Save" and "Cancel" buttons.

- In case of choosing **first check-in/last check-out**, user applies first authorized time as check-in and last authorized time as check-out.
- In case of choosing **separate check-in/check-out devices**, check-in/check-out devices can be designated separately using select device menu. In that case, limited to check in device, first time is applied as check-in and limited to check-out device, last time is applied as check-out. In case user inputs check-in or check-out for unselected device, log information is indicated as check-in or check-out but when creating a report, check-in or check-out is not applied.
- **Using function keys (BioStation)** – In case of choosing **using function keys (BioStation)**, limited to the cases when T&A key set in BioStation, it is applied to a report as check-in or check-out. This menu is applied only to BioStation. Therefore, BioEntry can't be used as T&A device in this case.

User can choose a device for T&A use thru select device menu.

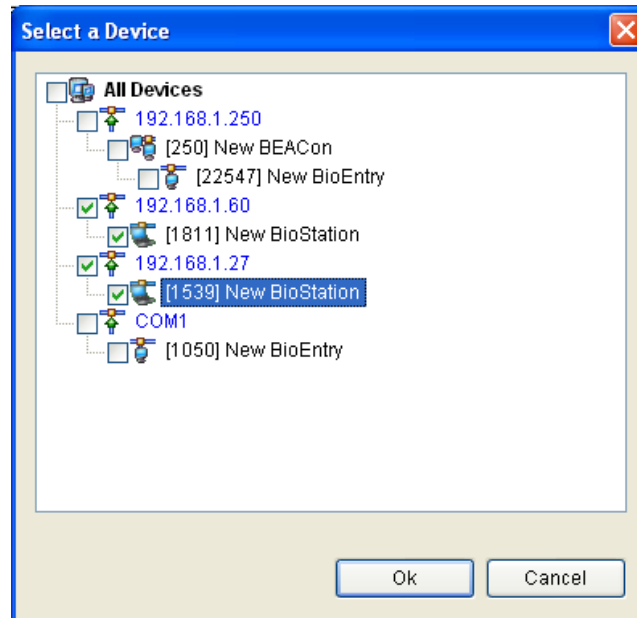

- In case of choosing **use all devices to collect attendance data**, all devices connected to network are used for T&A device. However, in case of choosing **using function keys (BioStation)**, BioEntry can't be used for T&A device.
- In case of choosing **use selected device to collect attendance data**, only selected device can be used for T&A device.

#### 10.2.2. Time setup

Select time setup menu on time attendance code definition page and set time attendance time as follows.

Detailed setting process is as follows

- Set standard time of work start in **from** — **start of a new day**
- Set minimum work hrs of applicable day in **minimum work hrs**. In case work hrs is less than set minimum work hrs, absence is applied to report. In case of setting minimum work hrs as 0, this function may not be used.
- Enter **check-in time**.
- Enter **check-out time**.
- Enter **maximum overtime hours**. In case one works overtime more than set maximum OT hrs, such hrs are not included in report as OT.
- Enter **minimum overtime hours**. In case of working overtime less than set minimum overtime hours, such hours are not applied as overtime in report.
- Set up **Nonworking Time** to exclude certain period of time from work time. This time will not be included in the working hour on report. You can select up to three Nonworking Time and see the Nonworking Time by using the drop down menu.

Note : Drop down menu on Nonworking Time is not to select a certain

Nonworking Time among the three Nonworking Times, but to just show the time setting of the Nonworking Time. Thus, once you set up two or three Nonworking Times on this menu, all of those Nonworking Times will be excluded from the working hour on report.

T&A event is applied to the occurred log from BioLite Net.

### 10.2.3. BioStation function key setting

Select BioStation function key setting menu and set log information and report display as below.

**T&A Event Setup**

BioStation Function Key Config

1 : None	2 : None	3 : None	F1 : In
4 : None	5 : None	6 : None	F2 : Out
7 : None	8 : None	9 : None	F3 : None
CALL : None	0 : None	ESC : None	F4 : None

Function Key:   Use this key for T&A

T&A Event:

Event Type:  ▼

Calculate as normal check-in/check-out event

Add work time after this event

After changing this setting, please update report again with 'Rebuild All' option.

OK Cancel

Detailed setting process is as follows:

- Select applicable key.
- In case of using selected key as T&A key, check on **Use this key for T&A**.
- Input **T&A event** for selected function key. Upon Monitoring and log check, input in T&A event for applicable key is displayed.
- Select Even Type among Check-In, Check-Out, In, Out. Selected events are used as basis of T&A result and computation of work hours.
- If you do not want to apply Late-In or Early-Out to a specific key, check on

### Calculate as normal check-in/check-out event.

Changes will apply only when report is updated after changing BioStation function key setting.

## 10.3. Setup Monthly Schedule

By setting monthly schedule, you can select working day and holiday, which are used as a basis of T/A report. On holiday, late-in, early-out, absence are not applied. Work hours on holiday will be added to the holiday work time.

- Press **Setup Monthly Schedule** button.

Monthly Schedule Setting

Name: New monthly schedule

Monthly Schedule

First Week	Sun	Mon	Tue	Wed	Thu	Fri	Sat
Second Week	Sun	Mon	Tue	Wed	Thu	Fri	Sat
Third Week	Sun	Mon	Tue	Wed	Thu	Fri	Sat
Fourth Week	Sun	Mon	Tue	Wed	Thu	Fri	Sat
Fifth Week	Sun	Mon	Tue	Wed	Thu	Fri	Sat
Sixth Week	Sun	Mon	Tue	Wed	Thu	Fri	Sat

Legend

- Working Day
- Holiday

After changing this setting, please update report again.

Save Cancel

- Select Working Day and Holiday and press **Save** button.
- To apply new monthly schedule to T/A report, check on the '**Rebuild All**' of the Report List window and press Update Report button.

## 10.4. Group Configuration for T&A Control





The screenshot shows a window titled "T&A Rule Group" with a close button in the top right corner. The window contains the following fields and options:

- Name:** A text input field containing "New T&A rule group(2)".
- Daily Rule:** A section containing seven dropdown menus for the days of the week: Sunday, Monday, Tuesday, Wednesday, Thursday, Friday, and Saturday. Each dropdown menu currently displays "New Attendance Code".
- Holiday Setting:** A section containing three dropdown menus: "Holiday Schedule" (displaying "New Attendance Code"), "Holiday Group1" (displaying "All holiday"), and "Holiday Group2" (displaying "Not Use").
- Monthly Schedule:** A dropdown menu displaying "New monthly schedule".
- Set as default:** A checkbox that is currently unchecked.
- Buttons:** "Save" and "Close" buttons are located at the bottom of the window.

#### 10.4.1. Use as default

By checking on **set as default**, apply selected T&A rule as basic rule. In case T&A rule is not set for certain users, basic rule applies to such users.

#### 10.5. How to prepare report

The screenshot shows the 'Report List' interface with the following sections:

- Filtering:** Company (None), Department (None), User ID (0), User Name (empty).
- Report Type:** Radio buttons for Daily Report (selected), Daily Summary, Individual Report, Individual Sun, and Etc. There is also a dropdown menu with 'In' and a 'Refresh' button.
- Period:** Start date (10/ 1/2007) and end date (10/31/2007) dropdown menus.
- Buttons:** Upload Log, Update Report, Rebuild All, View Report, and Export CSV file.

- Press **upload log** and import the latest log information. This process is to create a report based on the latest event logs, so even after completing upload log, log is not displayed on report list.
- Select company, dept. and user on setting (filtering) menu to creating a report.
- Choose either daily report or individual report on type menu.
- Choose start date and finish date of report on period menu.
- Press **update report** button.

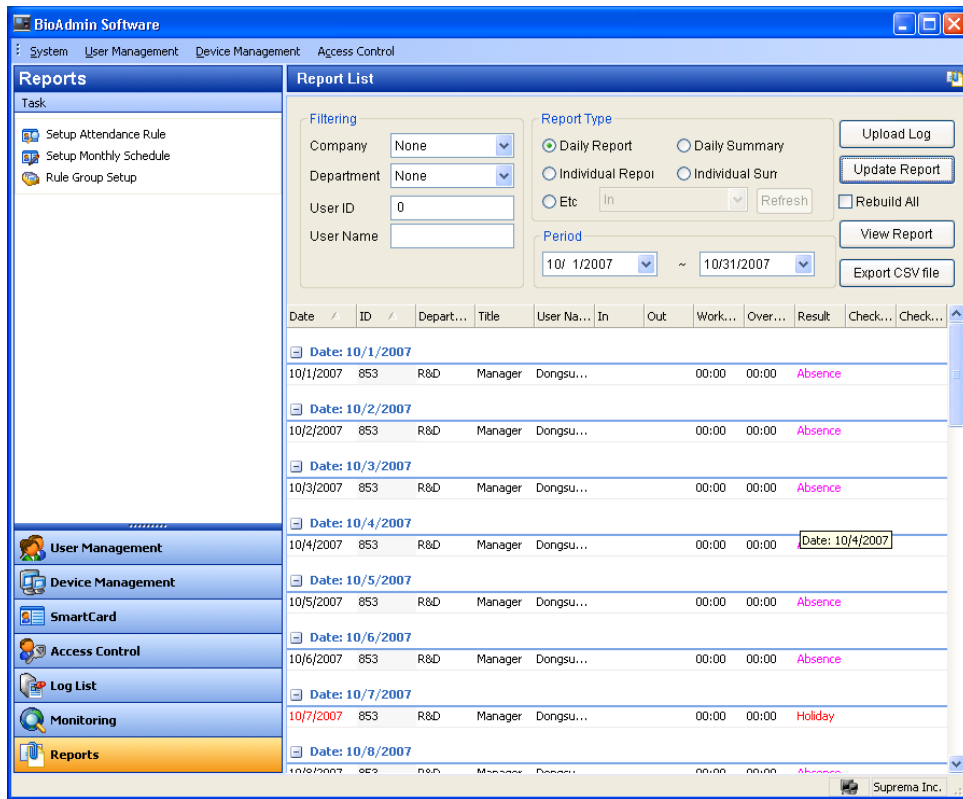



- Press **view report** button.

**Individual Report** 7/1/2006-8/31/2006

**ID : 853 User Name : Dongsuk, Suh**

Date	Department	Title	In	Out	Work Time	Over Time	Result	Check-In	Check-Out
7/1/2006	R&D	Manager			00:00	00:00	A		
7/10/2006	R&D	Manager			00:00	00:00	A		
7/11/2006	R&D	Manager			00:00	00:00	A		
7/12/2006	R&D	Manager			00:00	00:00	A		
7/13/2006	R&D	Manager			00:00	00:00	A		
7/14/2006	R&D	Manager			00:00	00:00	A		
7/15/2006	R&D	Manager			00:00	00:00	A		
7/16/2006	R&D	Manager			00:00	00:00	Holiday		
7/17/2006	R&D	Manager			00:00	00:00	A		
7/18/2006	R&D	Manager			00:00	00:00	A		
7/19/2006	R&D	Manager			00:00	00:00	A		
7/2/2006	R&D	Manager			00:00	00:00	Holiday		
7/20/2006	R&D	Manager			00:00	00:00	A		
7/21/2006	R&D	Manager			00:00	00:00	A		
7/22/2006	R&D	Manager			00:00	00:00	Holiday		
7/23/2006	R&D	Manager			00:00	00:00	Holiday		
7/24/2006	R&D	Manager			00:00	00:00	A		
7/25/2006	R&D	Manager			00:00	00:00	A		
7/26/2006	R&D	Manager			00:00	00:00	A		
7/27/2006	R&D	Manager			00:00	00:00	A		
7/28/2006	R&D	Manager			00:00	00:00	A		
7/29/2006	R&D	Manager			00:00	00:00	A		
7/3/2006	R&D	Manager			00:00	00:00	A		
7/30/2006	R&D	Manager			00:00	00:00	Holiday		
7/31/2006	R&D	Manager			00:00	00:00	A		
7/4/2006	R&D	Manager			00:00	00:00	A		
7/5/2006	R&D	Manager			00:00	00:00	A		
7/6/2006	R&D	Manager			00:00	00:00	A		
7/7/2006	R&D	Manager			00:00	00:00	A		
7/8/2006	R&D	Manager			00:00	00:00	Holiday		
7/9/2006	R&D	Manager			00:00	00:00	Holiday		

Wednesday, September 27, 2006 11:47:20AM Page 1 of 2

- Press  to save a file in varying formats.
- Press  to print out the report.

## 10.6. Edit Data

If necessary, administrator can add or correct user's T/A data.

- If you double click a specific T/A data on daily report or individual report, Edit Data window will be initiated.

- Enter desired event values on the **Event Property** box and press **Add Event** or **Edit Event** button.
- Press **Accept** button to apply the corrected data to T/A report.
- The changed events are displayed as “Result” field in grey color.

Date	ID	User Name	In	Out	WorkTime	OverTime	Result	Check-In	Check-Out
<b>Date: 2/1/2006</b>									
2/1/2006	853	Dongsuk, Suh	7:16:44 AM	6:57:10 PM	11:40	00:57	In	In	Out
<b>Date: 2/2/2006</b>									
2/2/2006	853	Dongsuk, Suh	8:17:31 AM	5:07:06 PM	08:49	00:00	Late In	In	Out

- The result can be modified at the report. By clicking “Result” of the report, the list to select displaying result will be shown as above figure, which is appeared on bold strokes and verified the changes easily.

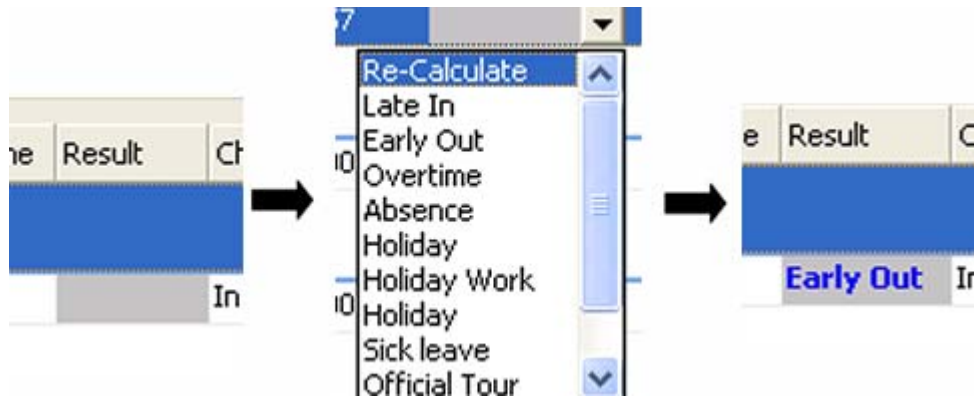

Note : After correcting report data, you should press **Update Report** button without checking on 'Rebuild All'. If you check on 'Rebuild All', T/A data will return to the original data before such correction.

## 11. Menu bar functions

### 11.1. System

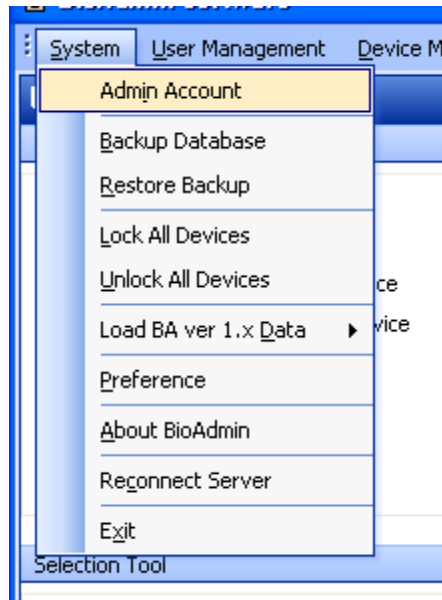

#### 11.1.1. Manage admin account

Add administrator to log in the BioAdmin or change password / user level of an existing administrator.

#### 11.1.2. Data backup

Make manual backup file as well as auto backup file on the option menu. Backup file is saved as date-serial number format at the server installed a path.

#### 11.1.3. Data recovery

After BioAdmin software modified to server/client type, data recovery is possible to copy backup file to server installed PC.

To recover a data, previously created backup file should be existed. By coping the file in the created folder as data-serial number type at the server installed path, all data can be restored as original backup status. All administrator & user information, rules, and log history are restored at the corresponding point, but data after restoration will be disappeared.

#### 11.1.4. Lock all devices

Lock/unlock linked all BioEntry and BioStation while using BioAdmin software. If administrator clicks lock all devices menu, all linked BioEntry and BioStation are locked and once locked, they don't react to any external packet except unlock command. In case of BioStation connected to the server, lock device does not support.

#### 11.1.5. Unlock all devices

By clicking 'unlock all devices' menu, user can unlock all locked BioEntry and BioStation. If lock password has been set, user needs to enter password to unlock.

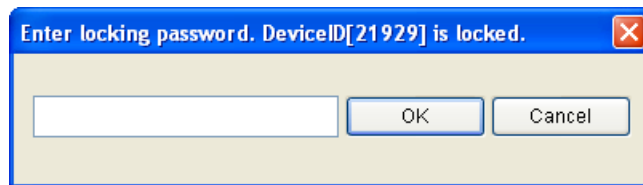

#### 11.1.6. Load BioAdmin 1.X data

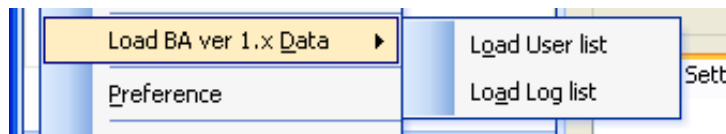

- Click **Load BioAdmin 1.X** data menu to import previous user data and log data generated while using BioAdmin software version 1.

Note : This menu can be used at a time of first execution of BioAdmin software version 3.0 only. It is because data is created anew after deleting existing data when importing previous data running this menu.

#### 11.1.7. Preferences

Preferences menu supports the following functions.

- Device Time Setting
- Automatic Locking
- Backup Options
- Security Option
- Template Format Option
- Mifare Card Type
- Access Control Option



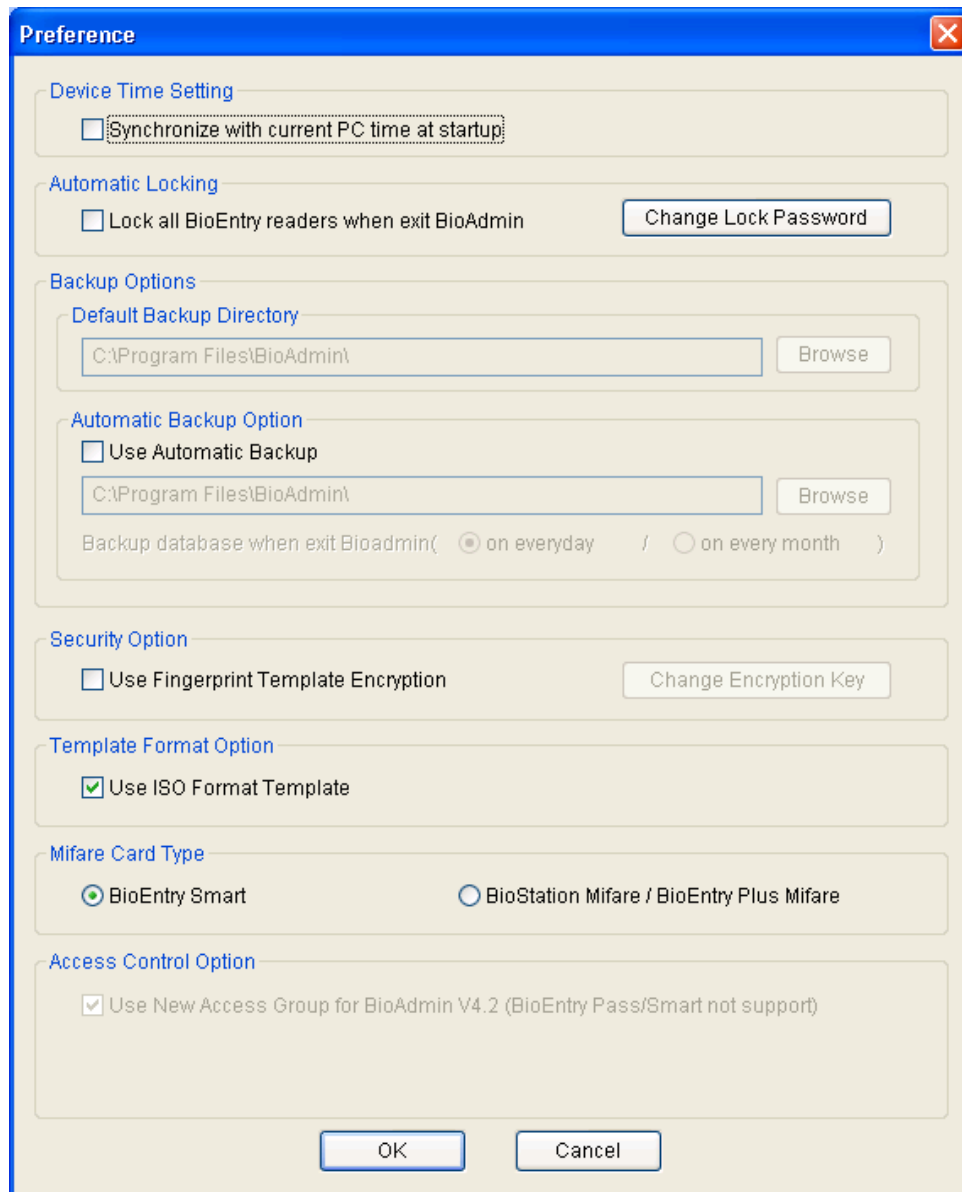

- Device Time Setting

By checking **synchronize with current PC time at startup** on preference window, administrator can set time of linked all devices by host PC time.

- Automatic Locking

BioEntry, BioStation, and BioLite Net can be locked by password to enhance the security. If the locked BioEntry, BioStation, or BioLite Net is found on the network, BioAdmin software requests to enter password to unlock BioEntry, BioStation, and BioLite Net Locking mechanism is enabled by the **Lock all**

**devices on exit** check box in this window or the **Lock All Devices** menu below the System menu in Command menu bar. If it is enabled, BioAdmin software locks the devices at termination of the program. The **Change Lock Password button** initiates the password management window.

- Lock password of BioEntry, BioStation, and BioLite Net can be changed by pressing change button and entering old and new password.

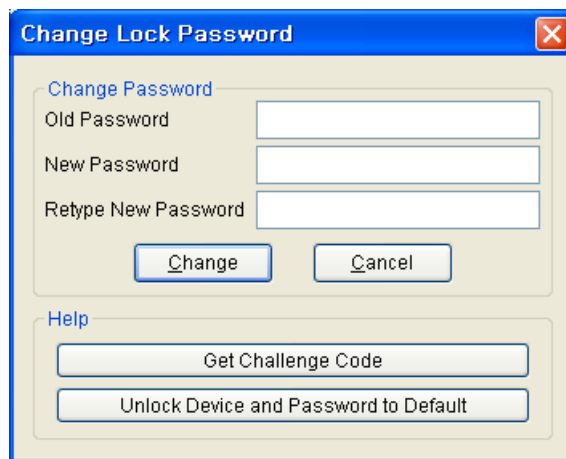

Note : As BioAdmin software doesn't save lock password, administrator should remember the password when using lock mechanism.

- Resolving the locked devices. If the devices are locked but cannot be unlocked in case of forgetting password, the following procedures are required. Obtain a challenge code file using the **Get Challenge Code** button and send the file to technical support team ( support@supremainc.com )

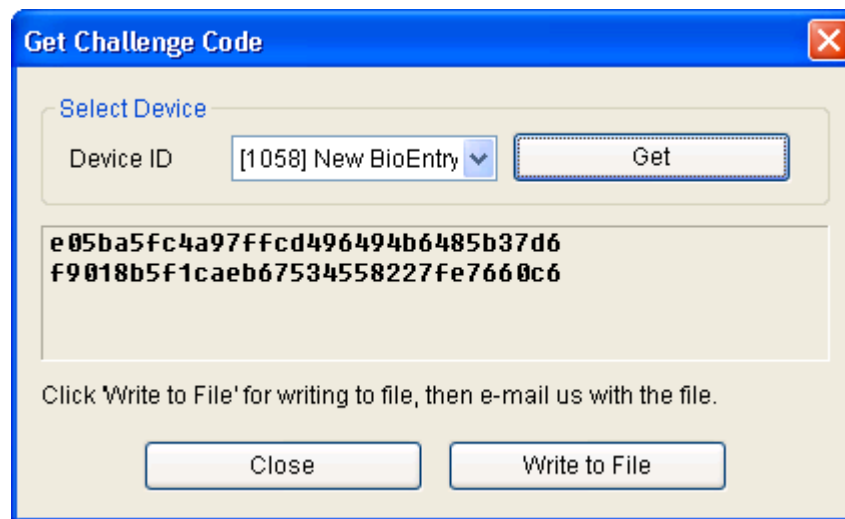

- The support team will send you the unlock code file corresponding to the challenge code. Use **Unlock a BioEntry and Password** to the **Default** button to resolve the device. Then, the device is unlocked and password is changed to default (null).

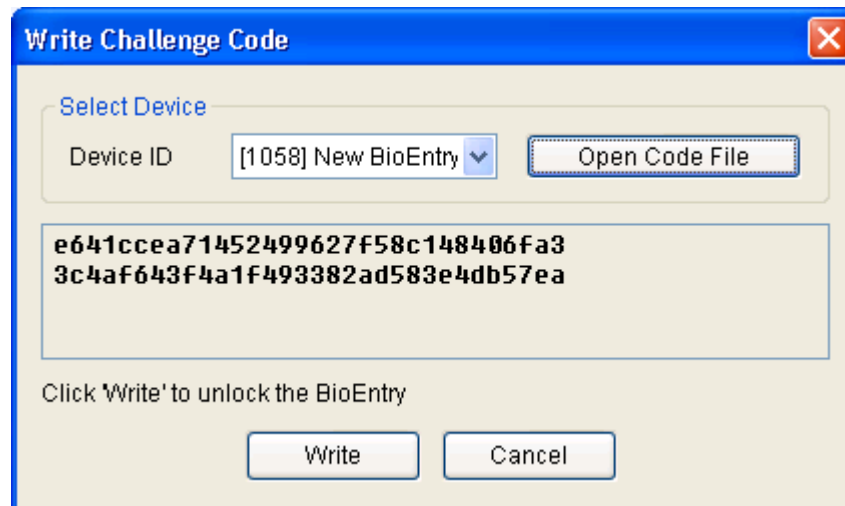

- Backup Options

- Default backup directory: Default backup directory for database can be specified on the preference page. Related backup files will be stored on the specified directories. In case of BioAdmin Software v4.0 above, this option cannot create a backup path, but backup file at the server installed path.
- Automatic Backup Option: By checking on the Use Automatic Backup check box, you can automatically save the backup database whenever you





- Enter Encryption Key.

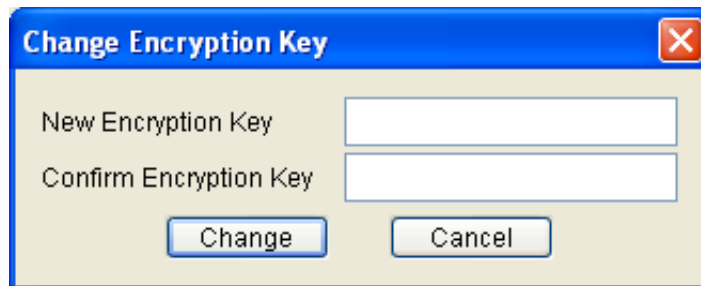

- Press Change button in Change Encryption Key window.
- Press OK button in Preference window.
- If you press Cancel button in Preference window or if the data encryption is interrupted by a network error, system will return to its earlier status before encryption.
- Whenever you change the encryption key, you need to apply the new encryption key for each of the connected BioStation. Also, you need to do so whenever you add a new BioStation to the network. Because encryption process will remove the existing user's templates on BioStation, you need to transfer the user's templates to the BioStation after finishing the encryption.
- When you use the encryption function, It is highly recommended to change the encryption key.
- Encryption key should be less than 31 digits.
- If the encryption is interrupted by a network error or by power failure, restart the BioAdmin program. Then, BioAdmin will automatically transfer the encryption setting to the remaining BioStation devices.
- You should be very careful in using the encryption function. If you are set different encryption key among BioStation devices, you may not be able to use the user's template compatibly among those devices.
- If the encryption key on host PC is different from that of BioStation, or if only either of host PC and BioStation is using the encryption option, following warning message will appear whenever such device is found on the

network. If you press **No**, such BioStation devices will be disconnected from the network.

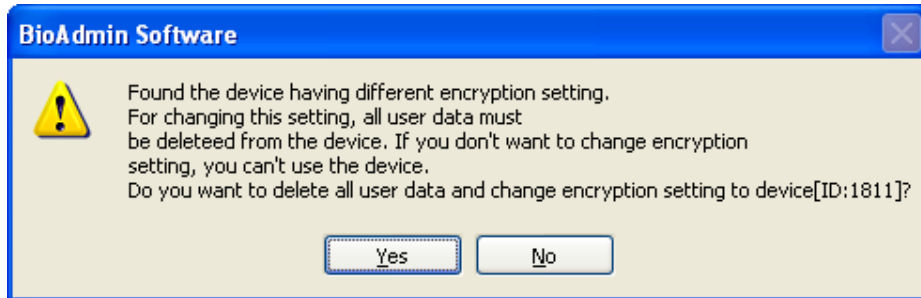

- Template Format Option

- Template format is a option to use both Suprema format template data and ISO 19794-2 standard format.
- Template format option should be used only when there is no fingerprint data on the devices. Otherwise, BioAdmin will remove all fingerprint templates on the devices and BioAdmin user DB template data.

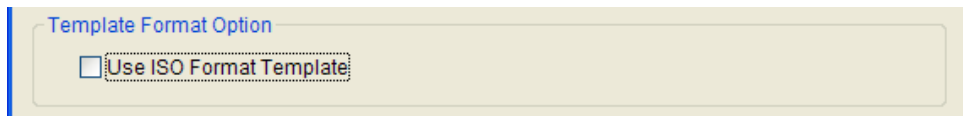

- Check on the Use ISO Format Template.
- If you select the ISO format template option, a warning message will appear. If you want to continue the encryption, press Yes button.

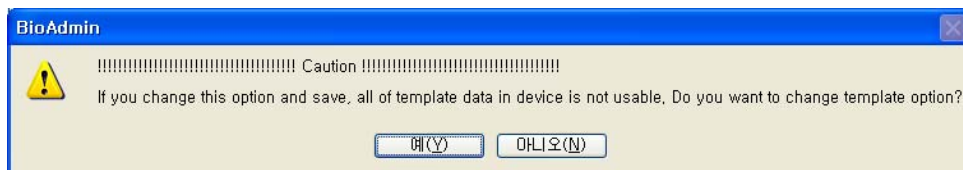

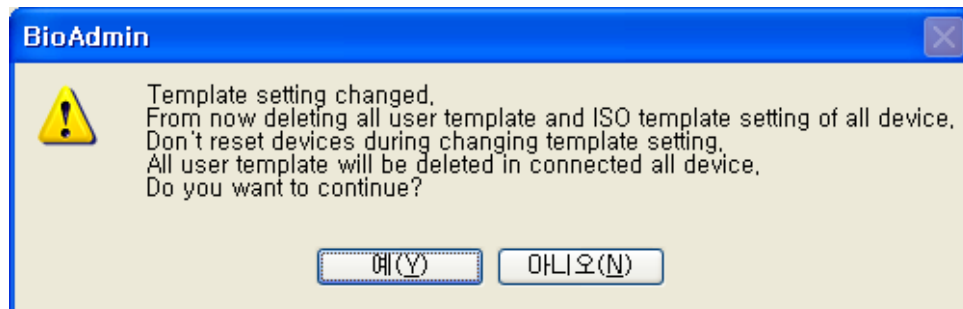

- After two caution messages, BioAdmin deletes all template data on the user DB.
- After deleting user data connected all devices, it changes ISO template option.
- The device, which does not support ISO Format Template Dara, cannot be used after turning on this option. In case of firmware upgrade, please upgrade it before turning on this option.

#### ● Mifare Card Type



- BioAdmin 4.2.2 supports BioStation Mifare and BioEntry Plus Mifare.
- Since Card Format Data used for BioStation Mifare and BioEntry Plus Mifare does not compatible with Smart Card Layout of BioEntry Smart, you have to select correct Data Format before using BioAdmin.
- In case of BioEntry Smart, the function of read/write of Smart Card is available regardless of this option. However, in case of Dual USB Card Writer, the Card Format to read/write is configured according to the option.

#### ● Access Control Option

- This option is for Access Control feature to apply to BioStation™ Version 1.4 and BioEntry Plus™. In case of the first time use, you have to create new Access Group and also user should be configured as new Access Group.
- Once configured this option, it cannot be default as disable option.

- Please refer to the “7. Access Control” for more in detail.

### 11.1.8. BioAdmin information

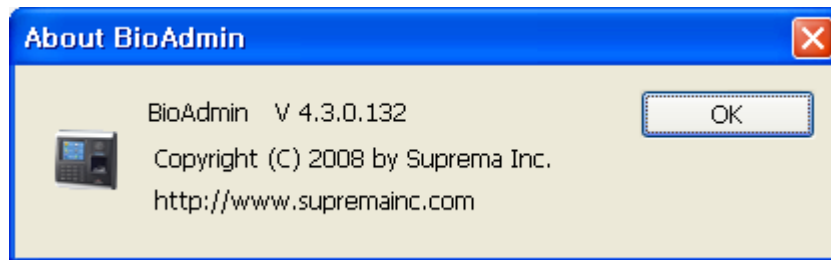

About BioAdmin on menu bar represents information on BioAdmin in use.

### 11.1.9. Reconnect Server

In case of bad communication, user can reconnect server to communicate again.

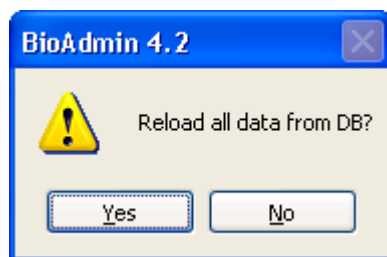

## 11.2. User Management

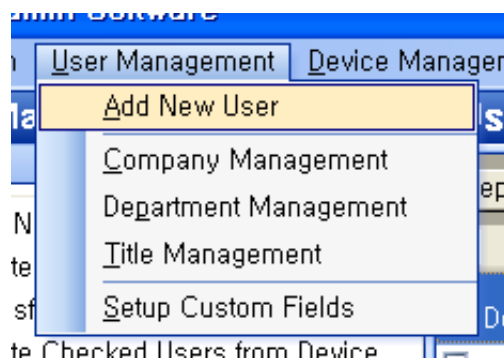

User management menu on menu bar supports following functions.



- Add New User
- Company Management
- Department Management
- Title Management
- Setup Custom Fields

For detailed setting, refer to 'chapter 5, user management'

### 11.3. Device Management

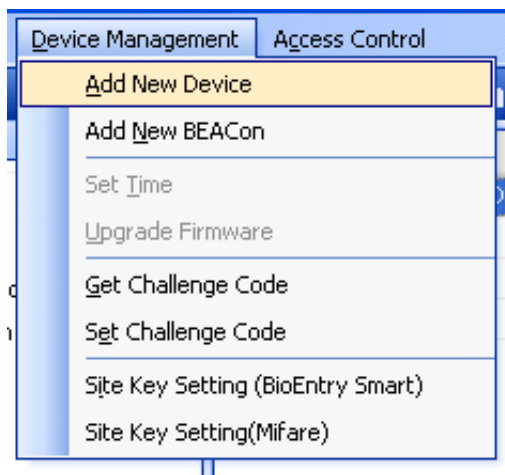

Device management menu on menu bar supports following functions.

- Add New Devices
- Add New BEACon
- Set Time
- Upgrade Firmware
- Get Challenge Code
- Set Challenge Code
- Site Key Setting

For detailed setting as to add new device, add new controller, import factory password code, factory password (password initialization), refer to 'chapter 6, device management'.

#### 11.3.1. Time setting

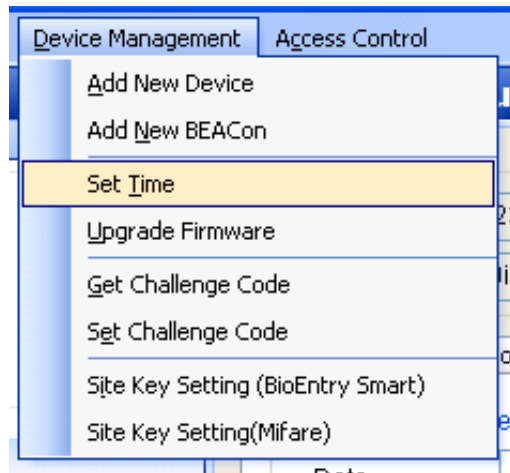

- You can synchronize the time of all of the networked BioEntry™ to the time of host PC. If you already checked on the **Synchronize current PC time at startup check box**, which is on Options → Preference → Device Time Setting, you do not need to synchronize the time on this menu.

### 11.3.2. FW upgrade

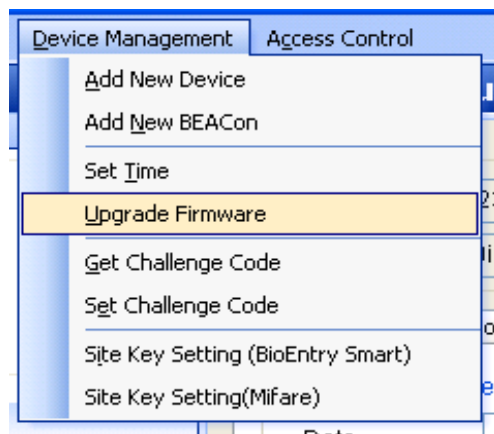

- By selecting the Firmware Upgrade menu, a pop-up window for firmware upgrade appears:

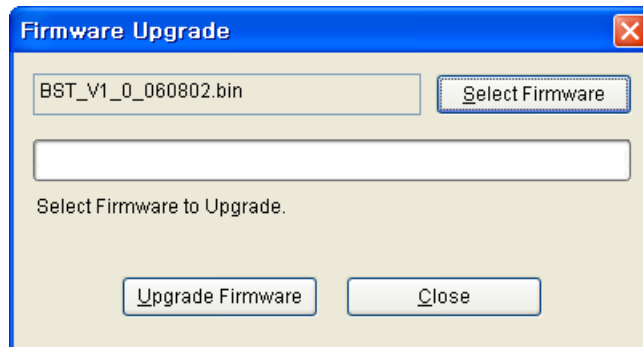

- Select a firmware file by clicking the **Search Firmware** button.
- Execute upgrade by clicking the **Upgrade Firmware** button.
- If BioEntry or BioStation is turned off or reset in the process of upgrading, restoration might be impossible.
- Firmware upgrade is processed for one device. Selection of a group or all devices is not allowed.

For detailed setting, refer to chapter 5 'user management'.

Note : Once firmware upgrade is complete, BioEntry and BioStation are rebooted automatically and connected to network. It is recommended not to do any other operation for about 5-10 sec after BioEntry or BioStation are rebooted due to upgrade.

### 11.3.3. Site Key Setting (BioEntry Smart)

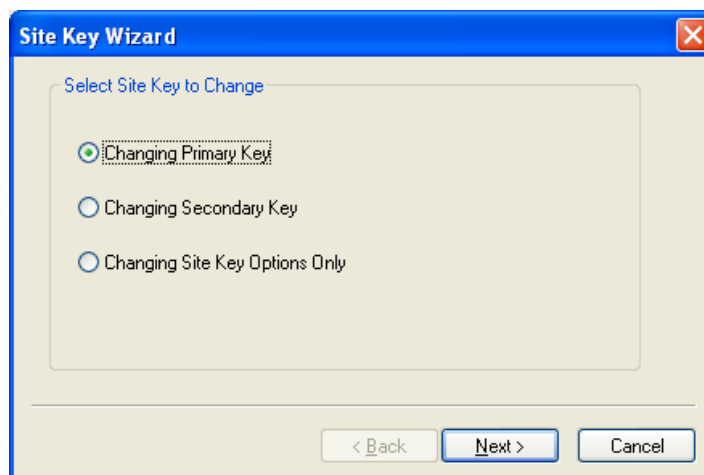

To prevent unauthorized access, Smartcards are encrypted with a 48 bit site key. For a BioEntry device to decrypt a Smartcard, the site key stored in the device should match with that of the card. Users can store as many as two site keys in the BioEntry device and select two advanced options. If the **Use Secondary Key** option is selected, the device will try both the primary and secondary keys when decrypting a Smartcard. If it is not selected, the device will try only the primary key. The **Auto Update** option is useful when changing the keys of Smartcards. With this option on, the device will re-encrypt a Smartcard with the primary key when it is encrypted with the secondary key.

**Note : *Site keys should be handled with utmost caution. If it is revealed, the whole system is not secure any more.***

- Primary Key

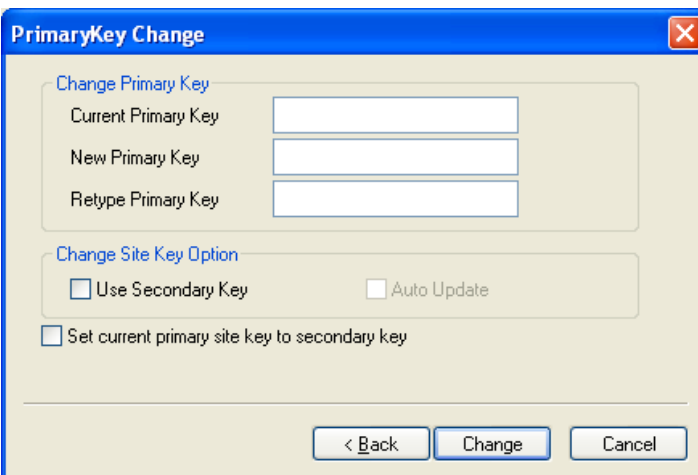

To change the primary key, you should enter the current and new primary keys. Besides the **Auto Update** option, you can also select the following options.

- **Set current primary site key to secondary key** : Replaces the secondary key with the current primary key before changing the primary key.

- Secondary Key

To change the secondary key, you should enter the current primary key and the new secondary key.

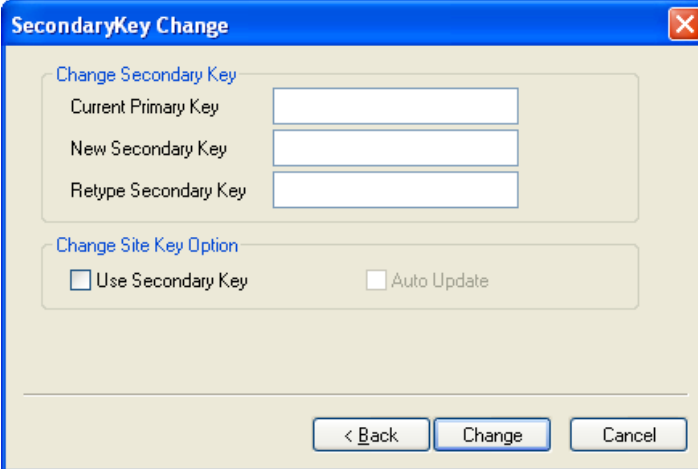

**SecondaryKey Change**

Change Secondary Key

Current Primary Key

New Secondary Key

Retype Secondary Key

Change Site Key Option

Use Secondary Key  Auto Update

< Back Change Cancel

- Key Options

You can also change the key options only. In this case, you only have to enter the current primary key with the options.

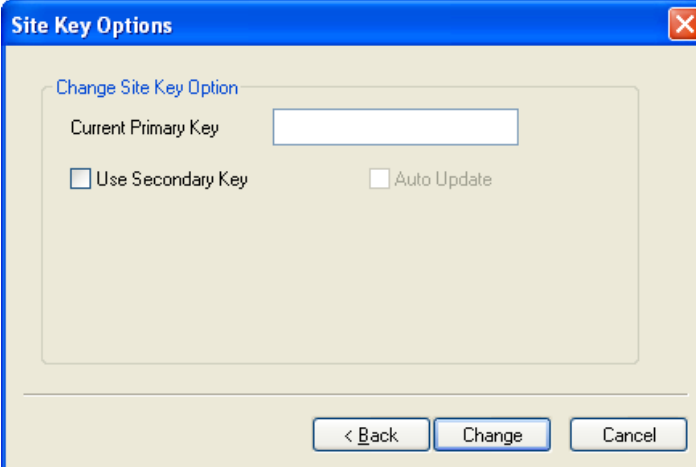

**Site Key Options**

Change Site Key Option

Current Primary Key

Use Secondary Key  Auto Update

< Back Change Cancel

#### 11.3.4. Site Key Setting ( Mifare )

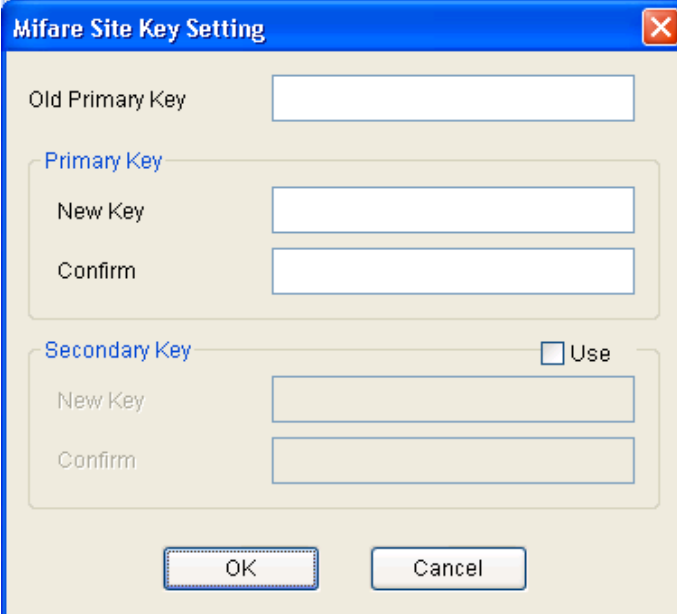

The image shows a dialog box titled "Mifare Site Key Setting". It contains the following fields and controls:

- Old Primary Key: A text input field.
- Primary Key section (grouped in a box):
  - New Key: A text input field.
  - Confirm: A text input field.
- Secondary Key section (grouped in a box):
  - Use: A checkbox.
  - New Key: A text input field.
  - Confirm: A text input field.
- OK and Cancel buttons at the bottom.

To prevent unauthorized access, Smartcards are encrypted with a 48 bit site key. For a BioStation™ / BioEntry™ Plus / Biolite Net™ device to decrypt a Smartcard, the site key stored in the device should match with that of the card. Users can store as many as two site keys in the BioStation™ / BioEntry™ Plus / Biolite Net™ device and select two advanced options. If the **Use Secondary Key** option is selected, the device will try both the primary and secondary keys when decrypting a Smartcard. If it is not selected, the device will try only the primary key.

**Note : *Site keys should be handled with utmost caution. If it is revealed, the whole system is not secure any more.***

#### 11.4. Access Control

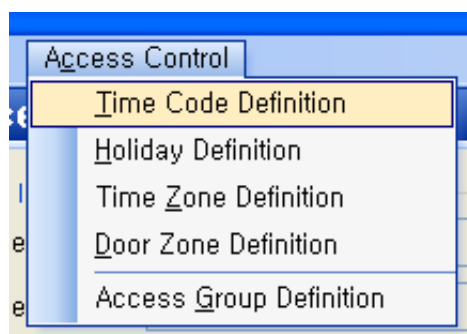

Access control menu on menu bar supports following functions.

- Time Code Definition
- Holiday Setting
- Time Zone Setting
- Door Zone Setting
- Access Group Setting

For detailed setting, refer to chapter 7. Access Control.

## Contact Information

Suprema Inc.

16F Parkview Office Tower, Jeongja-dong, Bundang, Seongnam, Gyeonggi, Korea

Tel : +82-31-783-4502

Fax : +82-31-783-4503

Website : <http://www.supremainc.com>

Sales inquiry : [sales@supremainc.com](mailto:sales@supremainc.com)

Technical inquiry : [support@supremainc.com](mailto:support@supremainc.com)