

**AUTOMATIC TELEPHONE ALARM DIALER**  
**DIAL 07M**

OPERATION AND INSTALLATION INSTRUCTION MANUAL

---



**TABLE OF CONTENT**

TABLE OF CONTENT ..... 1

INTRODUCTION ..... 2

    Construction and Use of Dialer ..... 2

INSTALLATION OF DIALER ..... 2

    Connection of power supply ..... 2

    Connection of telephone line ..... 2

    Connection of input lines ..... 2

    Connection of PGM1 and PGM2 output lines ..... 2

    Switching on power supply voltage – EEPROM memory resetting ..... 3

    Default (manufacturing) settings of EEPROM memory ..... 3

    Default settings ..... 3

    Acoustic signals ..... 3

    Hexadecimal notation system ..... 4

    LED indicators ..... 5

    LED indicator – „TEL.” ☎ ..... 5

PREPARATION FOR DIALER OPERATION ..... 5

DIALER OPERATION ..... 5

    READY mode ..... 5

    ALARM mode ..... 5

    ALARM RESETTING ..... 6

    NOTIFICATION WITH AN ALARM MESSAGE ..... 6

    PROCESS OF TELEPHONE CONNECTION ..... 6

    DETECTION OF PHONE PICK-UP ..... 6

    DISABLING DETECTION OF PHONE PICK-UP – "BLIND" TRANSMISSION OF ALARM MESSAGE ..... 6

    CALLING DIALER FROM OUTSIDE ..... 6

    DOUBLE CALL FUNCTION ..... 6

    DIALER CODES ..... 7

PROGRAMMING ..... 7

    METHODS OF TELEPHONE NUMBER PROGRAMMING ..... 7

USER PROGRAMMING ..... 8

INSTALLER PROGRAMMING ..... 10

TECHNICAL DATA ..... 12

DRAWINGS ..... 12

## INTRODUCTION

### Construction and Use of Dialer

The Automatic Telephone Alarm Dialer is a device used for an automatic transfer of information on an occurrence of an alarm situation (fire, burglary, etc.). The DIAL07M dialer is capable of transmitting a verbal message up to eight telephone subscribers and a text message up to two pager system subscribers. All device operation configuring parameters and verbal alarm message are stored in EEPROM type memories and are not lost at a power supply loss.

DIAL 07M enables:

- recording a 15-second verbal alarm message,
- recording of two additional verbal messages about state of A3 control input,
- notification of up to eight telephone subscribers,
- notification of up to two pager subscribers,
- tone (DTMF) and decade (PULSE) dialing,
- dialer connection by use of external call function,
- monitoring of telephone line voltage and signalization of a voltage loss.

DIAL 07M is provided with:

- main code enabling alarm resetting and device programming,
- user code enabling only alarm resetting,
- installer code enabling dialer configuring,
- delay alarm input (A1 line),
- instant alarm input of H24 type (A2 line),
- control input (A3 line),
- alarm signaling output (PGM1),
- telephone line voltage loss signaling output (PGM2),
- built-in capacitive microphone,
- stereo mini-jack output for messages reproducing and listening to the telephone line.

## INSTALLATION OF DIALER

The dialer should be hung on a vertical structure element (wall), far from any heat and moisture sources. All electric connections should be made prior to power supply connection. After programming of the dialer, it is recommended to perform an alarm action simulation and check the notification efficiency in practice.

### Connection of power supply

The dialer power supply cables should be connected to terminals marked with +/- 12Vdc. The dialer requires DC power supply within a range from 11 to 15 Vdc. The dialer power supply system is protected with a polymer type electronic circuit breaker and does not need to be replaced after fault condition. After the dialer is connected to power supply for the first time, it operates using the default (manufacturing) configuration settings, without the recorded verbal messages.

### Connection of telephone line

A telephone line should be connected to the dialer terminals marked with the caption "LINE". Other devices, which use the telephone line, should be connected to the terminals "TEL". Such a connection guarantees that the devices connected to the terminals "TEL" cannot disturb the dialer when operating with telephone line. The other devices (fax, modem etc.) using the telephone line can be also connected parallel with the dialer, i.e. to the terminals "LINE", but in this case they can disturb or even stop the dialing and alarm notification process.

### Connection of input lines

There are three inputs of the dialer: A1, A2 and A3. The A1 and A2 inputs are the alarm inputs. Input A3 has control function and can stop the alarm and disabling monitoring of A1 line. All the dialer inputs have identical electric structure. Each of them can be configured as NO or NC. The alarm inputs are usually triggered with a contact, but it can be also triggered through supplying a suitable voltage level. The line programmed as NO can be triggered by supplying the power supply "minus" or by using NO switch. Line configured as NC can be triggered by using NC switch or by supplying the power supply "plus", however when triggering by supply "plus" input should be previously connected with ground ("supply minus") by a resistor within the range from 0.5 to 2K $\Omega$ .

*A1 input. Delay alarm input. Triggering the input results in switching of the dialer into the alarm mode after **the alarm time delay**. Monitoring of the A1 input does not operate when the dialer is in the programming mode or when the A3 line is triggered.*

*A2 input. Instant alarm input. Triggering this input starts alarm without any delay. The dialer monitors the input regardless the condition of the A3 line. Monitoring of the A2 line does not operate in the programming modes.*

*A3 input. Controls monitoring of A1 input and can stop the alarm. When A3 is triggered monitoring of A1 line is switch off. Momentary triggering of the A3 input during an alarm results in the alarm reset.*

### Connection of PGM1 and PGM2 output lines

The outputs are the "open collector" type universal outputs of 1A dc current capacity. The outputs are normally opened (which corresponds the high impedance condition). When closed, the outputs supply the power supply "minus" potential. A maximum potential of +24V against the dialer power supply "minus" can be connected to the programmable output. The programmable outputs are protected from overvoltage and are capable, without any additional control elements (relays), of controlling the switching of most popular types of alarm signaling devices.

*PGM1 output. The output goes to ON state each time the dialer starts alarm. The output returns to OFF state after three minutes or after alarm is reset (cancel). When the alarm has been switched on by entering **a duress command**, the PGM1 output is not closed (the duress command – see the "ALARM" Mode section).*

*PGM2 output. The output is switched ON when the dialer recognizes a 3 minutes lack of telephone line voltage. The output returns to OFF state as soon as the telephone line voltage returns.*

**Switching on power supply voltage – EEPROM memory resetting**

Each time after switching the power supply on, the dialer tests the position of the Z1 jumper. In case it is in the EEPROM RESET position, the dialer resets all current settings in the EEPROM memory and assigns them the default (manufacturing) values, then the dialer goes to the READY mode. If, during switching the power supply on, the Z1 jumper is in the NORMAL POSITION, the dialer skips the process of the EEPROM memory resetting.

*Note!*

*After resetting the EEPROM memory, the Z1 jumper should be returned to the DEFAULT POSITION.*

**Default (manufacturing) settings of EEPROM memory**

During the manufacturing process of the dialer, a set of parameters, whose name is **default (manufacturing) settings**, is entered into the EEPROM memory. The settings are modified in the dialer programming or configuration process. The default values can be returned any number of times by performing the **EEPROM memory resetting** procedure. EEPROM memory is usually reset in case of a loss of the previously programmed dialer codes or in order to fix the technical trouble called "EEPROM memory error".

**Default settings**

A1 line type	:NO / SLOW
A2 line type	:NO / SLOW
A3 line type	:NO / SLOW
Alarm delay on A1 input	:0 seconds
Dialing options 1	DT signal waiting time 4 sec./ Don't dial the number when no DT.
Dialing options 2	Pulse dialing (PULSE) / Detect telephone pick-up.
Number of external rings	:0 (function off)
Double call function time	:0 minutes (function off)
"A3 triggered" message	:no message
"A3 normal" message	:no message
Alarm message	:no message
Text message to PAGER system station	:no message
User code	:1111
Main code	:0000
Installer code	:1234

















**Acoustic signals**

During the dialer operation the following acoustic signals can occur:

NAME OF SIGNAL	SYMBOL OF SIGNAL	INTERPRETATION OF SIGNAL
Error signal	( - )	One long signal lasting about 2 sec. Occurrence of the signal informs about a programming error or performing an invalid operation. The signal occurs also after entering the wrong code.
Error signal – identical codes	( - - )	Two long signals. The signal occurs at an attempt of programming a code, which is identical with the previously programmed one.
Encourage signal	(** **)	Two series of two short signals each. The encourage signal informs that the dialer awaits entering a further part of a command or code.
Operation completion signal	(*** ***)	Two series of three short signals each. The operation completion signal informs that the dialer recognized and performed the entered command.

**Hexadecimal notation system**

With reference to some functions of the device, the HEXADECIMAL notation system (HEX in short) is used. In the system, a number can be represented as a digit from the range 0,1...9 or a letter A, B, C, D, E and F. The number interpretation and programming methods in the HEX system are shown in the following table.

NUMBER IN DECIMAL SYSTEM	NUMBER IN HEXADECIMAL SYSTEM	PROGRAMMING METHOD (KEYS)	LED INDICATOR PRESENTATION METHOD
1	1	[1]	
2	2	[2]	
3	3	[3]	
4	4	[4]	
5	5	[5]	
6	6	[6]	
7	7	[7]	
8	8	[8]	
9	9	[9]	
10	A	[*][0][*]	
11	B	[*][1][*]	
12	C	[*][2][*]	
13	D	[*][3][*]	
14	E	[*][4][*]	
15	F	[*][5][*]	
0	0	[0]	









The drawing symbolizes all LED indicators are flashing.



**LED indicators.**

The dialer is provided with five LED indicators, four of which are used for indication of the dialer operation status or are used during programming. The names of the indicators are: [ALARM][1] , [READY][2], [PROGRAM.][4] and [TEST][8]. The digits next to the LED indicators enable easy interpretation of the numbers in the HEX system.

The method of interpretation of the LED indicator status is as follows:

ALARM LED is on		The dialer is in the alarm mode.
READY LED is on		The dialer monitors the A1 and A2 alarm inputs.
READY LED flushes		The A3 line is triggered, the dialer monitors only the A2 line, monitoring of the A1 line is off.
ALARM LED flushes		The dialer has been in the alarm mode and the alarm has not been reset yet by either entering the proper code or triggering the A3 line.
ALARM and READY are on		The dialer is now counting time delay before alarm mode. Resetting the alarm during the delay protects from commencing the telephone notification action and alarm signaling at the PGM1 output.
PROGRAM. LED is on		The dialer is in the user programming mode.
TEST LED is on		The dialer has recognized an occurrence of at least one technical problem.
TEST LED flushes		Since the time of the latest read-out of the technical problem, ([*][1]function), the dialer has recognized a new technical problem.
PROGRAM. and TEST LED are on		The dialer is in the configuration mode.

In the programming mode, the LED indicators are additionally used for visualization of the entered parameter values. The LED indicators are assigned with the numbers 1,2,4 and 8. Reading of the HEX number, which is displayed by the LED indicators, is obtained by adding the numbers located next to the active LED indicators. The "zero" digit is indicated by flushing of all the LED indicators.

An example of reading of a number value indicated in the HEX code:  
PROGRAM.[4] and TEST [8] indicators are on.



The number 8 corresponds the TEST indicator and the number 4 corresponds the PROGRAM indicator. The value of the presented HEX number is therefore 8+4=12, which should be interpreted as the number "C" in the HEX system.

**LED indicator – „TEL.” ☎**

In addition to the mentioned LED indicators, the dialer is also provided with another (fifth) LED indicator, marked with a symbol of the telephone. When the indicator is on, it means that the dialer is in telephone communication process and the telephone line is busy.

**PREPARATION FOR DIALER OPERATION**

In order to prepare the dialer for operation, electric connections should be made and then the installer programming mode should be entered and the dialer operation configuration parameters should be set. After that, switch to the user programming mode and perform the necessary additional programming operations.

**DIALER OPERATION****READY mode**

When in the READY mode, the dialer monitors the A1 alarm line and the A2 line. If the triggering condition occurs at the A1 input, dialer start time delay before alarm and after the time delay has expired enters ALARM mode. . Triggering A2 input results in the immediate switching of the dialer to the alarm mode. The READY mode is indicated by the READY LED indicator, which is on. If the A3 input is in the triggering mode, then the A1 input monitoring is switched off. Blocking of the A1 line monitoring is indicated by flushing of the READY led. The condition of the A3 line has no effect on the A2 input monitoring.

**ALARM mode**

The alarm mode is entered as a result of recognition of the A1 or A2 input triggering or it can be performed from the dialer keypad after an **duress command** is entered. In the alarm mode, the dialer performs telephone connections with the numbers from the alarm telephone list and closes the PGM1 output for 3 minutes. If the alarm has been started from the dialer keypad through entering the duress command, the PGM1 output, which normally signals the alarm, is not switched on. The duress command is entered by entering the user main code or user code increased or decreased by "1" in the last position.

An example of entering the duress command:

[Main code+1][#]

[Main code-1][#]

[User code+1][#]

[User code-1][#]

All the commands start the operation of the silent telephone notification, i.e. with the PGM1 output off.

Note! After completion of the telephone notification operation, the dialer automatically returns to the monitoring mode and is ready for new alarm.

### ALARM RESETING

Resetting of the alarm results in an interruption of the telephone notification operation and switch off PGM1 output. After the alarm is reset, the ALARM LED stops flashing. The alarm can be reset from the dialer keypad using the commands [Main Code] [#] or [User Code] [#] or [Main Code] [\*] [#]. The latter command, in addition to resetting the alarm, makes the dialer switch to the user programming mode.

Note! The dialer allows for three attempts of entering the code. The third failed attempt results in blocking the keypad for 1 minute. During entering the codes or other keypad manipulations the dialer does not interrupt the telephone notification operation nor stops the alarm input monitoring.

Important : Resetting the alarm can be performed from a remote location through a momentary or permanent triggering of the A3 line.

### NOTIFICATION WITH AN ALARM MESSAGE

The dialer try to get a double connection with each of the pre-programmed telephone subscribers specified in the alarm list. A telephone connection is qualified as a "notification", if the dialer, based on an analysis of electric signals in the telephone line, recognizes the moment of phone pick-up by the called subscriber and performs a transmission of the alarm message. If option "Don't detect for telephone pick-up" (Installer Programming function [\*][6]), each dial attempt is treated as a notification, no matter if the subscriber has or has not picked up the phone. Telephone connections are performed in four dialing cycles. In each dialing cycle the dialer performs one attempt with every telephone number. The telephone connections are performed according to their sequence on the telephone list. The subscribers, who have receive twice notification are skipped during the further notification process. The pager system subscribers are selected as the first priority, i.e. prior to the numbers of the subscribers notified with a verbal message. A text message (see the User Programming function [\*][9]) is transmitted to the pager system subscribers. A notification to the pager system subscribers is acknowledged as soon as the dialer receives a signal, which confirms the receipt of the text message transmitted by a pager system station.

### PROCESS OF TELEPHONE CONNECTION

After connecting into the telephone line, the dialer awaits an answer signal from a telephone exchange (DT) and when the signal has been recognized, the dialer starts to dial the number. After dialing, the dialer awaits an answer (phone pick-up) of the dialed subscriber and after that performs a double transmission of the alarm message and goes to a connection with another alarm number. The maximum time of waiting for dial tone of a telephone exchange (DT) is set up in the Installer Programming (function [\*][5]) and can be set at 4 or 8 sec. When in the required time of 4 or 8 sec. the dial tone has not been recognized, the dialer goes to dialing another telephone number. If the option "Dial the number despite no DT signal" is activated, the dialer ignores the lack of dial tone signal and despite of it dials a phone number and transmit message.

### DETECTION OF PHONE PICK-UP

Dialer detects phone pick-up of dialed subscriber after:

- disappearance of "returned call signal" or
- voltage polarity change in telephone line

Note! A telephone connection, in which an answer of the called subscriber has been recognized by one of the above described manner, is qualified as successful and the subscriber as having been notified once.

### DISABLING DETECTION OF PHONE PICK-UP – "BLIND" TRANSMISSION OF ALARM MESSAGE

In justified cases, during the dialer configuration, the installer can switch off option "Don't detect phone pick-up". Enabling the option results in an unconditional transmission of the alarm message directly after dialing the telephone number. When the option is on, the dialer recognizes each attempt of a telephone connection as a notification. When the option is on, the dialer dials each of the pre-programmed alarm numbers twice no matter if the subscriber has or has not picked up the phone.

Note! When the option "Don't detect phone pick-up" is on, it is recommended to program the same telephone number in two or more positions to enhance the notification certainty.

### CALLING DIALER FROM OUTSIDE

The dialer is capable of accept the phone calls from outside. During the configuration, the installer defines the number of rings, after recognition of which the dialer has to start handling an external telephone call. (See the Installer Programming function [\*][7]). The dialer, after recognition of the required number of rings, switches into the telephone line and transmits a verbal message corresponding to the current condition of A3 line. When A3 is triggered dialer transmit message "A3 triggered" or when line is in normal condition dialer transmit message "A3 normal" (recording of this messages see function [\*][9][1] and [2] in Installer programming mode). If an alarm occurred during the last READY cycle, the dialer additionally to the messages about A3 line plays the alarm verbal message, the same as during the alarm action. After transmitting the messages, the dialer automatically disconnects telephone line. Transmission of the "A3 triggered" message is preceded with three long acoustic signals (- - -), whereas transmission of the "A3 normal" message is preceded with a series of three acoustic signals composed of short pulses (\*\*\* \*\*\*)).

### DOUBLE CALL FUNCTION

In case the dialer recognizes in the telephone line the number of rings, which is equal with the number pre-declared in the configuration, then no matter if the Double Call function is on or off, the dialer hooks into the telephone line and handles the call. However, if the recognized number of rings is smaller than the pre-set value in the configuration and the Double Call function is on, the dialer starts the process of counting pre-declared time delay. If, during this delay the dialer recognizes rings again, it does not wait for the required number of rings, but immediately after the second ring connects into the telephone line and handles the connection. This function enables other devices, which are connected to the telephone line along with the dialer, the priority access to receive a call and provides that any third parties do not see the presence of the dialer in the telephone line.

Note! Enabling of the Double Call function is done through programming the time delay (the Installer Programming [\*][7] value bigger than zero). The Double Call function is disabled through programming the delay at 000.

Note! Please remember that the **Double Call** function can operate properly only if any other devices, which use the telephone line along with the dialer, do not intercept a call after recognition of less than two rings, because it would disable the dialer to intercept the call.

**DIALER CODES**

The dialer is provided with the following codes:

- **Main code**                    [MC],
- **User code**                     [UC],
- **Installer code**               [IC].

Each of the codes can have the length from 4 to 8 digits. The main code enables resetting the alarm and entrance to the user programming mode. The user code enables only resetting the alarm. The installer code enables entrance to the installer programming mode.

*Note!*  
The codes must be different. The dialer does not allow programming of two identical codes. In case of an attempt of programming a code identical with another, already existing code, the dialer signalsizes the code programming error (error signal - - ).



**PROGRAMMING**

The dialer is provided with two programming modes: "User Programming" mode and "Installer Programming" mode. The "User Programming" mode can be accessed from the READY or ALARM mode using the command [Main Code] [\*] [#]. The "Installer Programming" mode can be accessed only from the user programming mode using the command [\*] [0] [Installer Code] [#].

*Note!*  
In either of the programming modes the dialer does not monitor the input lines nor answers external calls.

**METHODS OF TELEPHONE NUMBER PROGRAMMING**

The dialer enables programming two telephone numbers to PAGER system stations and eight alarm numbers to subscribers notified with a verbal alarm message. Each number can consist of 16 digits. In addition to the digits 0, 1..9, some special characters can be inserted in a telephone number. The dialer accepts the following special characters:

SPECIAL CHARACTER	METHOD OF CHARACTER PROGRAMMING	LED INDICATOR STATUS	CHARACTER FUNCTION
HEX B	[*][1][*]		This character is used for switching to another (alternate) dialing system, i.e. from DTMF to PULSE or inversely.
HEX C	[*][2][*]		This character introduces a 4-second interruption in dialing. After the break has elapsed, the dialer resumes dialing.
HEX D	[*][3][*]		The character makes the dialer wait for a dial tone (DT) signal. Programming the character results in stopping the dialing process until a DT signal occurs.



## USER PROGRAMMING





The user programming mode is entered from the monitoring mode or alarm mode using the command:

**[\*][Main Code][\*][#]**

After the mode has been entered, the dialer turns on the PROGRAM LED. The following functions are available in the user programming mode:

### [\*][1][#] – Technical problem read-out.

After entering the function ([\*][1]), the dialer signalizes the existence of recognized technical problems through turning on the corresponding LED indicators. A return from the function is done by depressing the key [#].

PROBLEM CODE	METHOD OF LED INDICATOR PRESENTATION	MEANING OF PROBLEM
1		A telephone line voltage loss. The problem disappears when the telephone line voltage is back. Recognition of the error is additionally signalized on PGM2 output.
2		A telephone exchange does not respond (no DT signal). The problem disappears as soon as a DT signal occurs at the next telephone connection.
4		This problem indicates that some errors in the data memory (EEPROM) occurs. In consequence, the dialer malfunctions may occur. In order to solve the problem, the EEPROM memory should be reset and the dialer should be programmed again. If reprogramming does not solve the problem, the dialer should be returned to the service for repair.
8		The problem indicates an error in the program memory (ROM). If such a problem is found, the dialer should be returned to the service for replacement of the ROM memory system.

### [\*][2][N][Telephone number][#] – Programming of N-th alarm number

In place of the letter N, enter a digit from 1 to 8, which determines which of the numbers will be programmed. The number programming completion is obtained with the character [#]. Each entered digit or special character is presented on the LED indicators in the HEX system. A number is deleted from the alarm telephone list by programming it as a blank number.

Example:

*[\*][2][4][1234566789][#] – the fourth alarm number is programmed*

*[\*][2][4][#] – the fourth alarm number is erased*

*[\*][2][N][#] – the N-th alarm telephone number, [N]=1..8*

### [\*][3][N]([\*])[#] – Read-out of N-th alarm number

After entering the function, the LED indicators present the first digit of the telephone number in the HEX system. The key [\*] provides a skip to the presentation of the next digit of the number. The function is abandoned automatically after the last digit of the telephone number is displayed or may occur earlier after using the key [#].

### [\*][4]([#]) – Recording of alarm message

Immediately after depressing the key [4], the dialer begins recording of an alarm message. The message should be recorded by speaking from a distance of about 20 cm from the dialer keypad. The message recording is completed and the function is abandoned when the available recording time (15 sec.) has elapsed or it can occur earlier, after depressing the key [#].

### [\*][5]([#]) – Playback of alarm message

Immediately after depressing the key [5], the dialer begins to play back the alarm message recorded in the memory. The message can be listened to using a set of headphones plugged into the dialer headphone output. The headphones need to be equipped with a "mini-jack stereo" of 3.5 mm diameter. The end of playback and exit from the function is performed automatically after playing back the complete message or may occur in any moment by using the key [#].

### [\*][6][N][Telephone number][#] – Programming of pager system telephone numbers

The character [N] should be overwritten with the digit [1] or [2] depending on that whether the first or the second pager system subscriber telephone number should be programmed. Each entered digit or character are presented by the LED indicators in the HEX system. Removing a number from the list is performed by programming the number as a blank one.

Example:

*[\*][6][2][12345678][#] – programs the second number to a pager system subscriber.*

*[\*][6][1][#] – erased the first number to a pager system subscriber.*

### [\*][7][New main code][#][New main code][#] – Programming of main code.

After depressing the key [7], the programmer has to make a double entry of the new main code. Each time the new code has to be ended with the character [#]. When the two codes are identical, the new code is stored in the memory, otherwise a programming error is signalized and the function is abandoned. The code length must stay within the range from 4 to 8 digits. The digits of the entered code are displayed by the LED indicators in the HEX system.

Example:

- [\*][7][12 12][#][12 12][#] – programs the main code as 12 12
- [\*][7][12 123][#][12 123][#] – programs the main code as 12 123
- [\*][7][12 1234][#][12 1234][#] – programs the main code as 12 1234
- [\*][7][12 123434][#][12 123434][#] – programs the main code as 12 123434

[\*] [8] [New user code] [#] [New user code] [#] Programming of user code

Programming of the user code is carried out in the same manner as programming of the main code.

[\*] [9] Programming of message to pager system

Programming of the message to the pager system is performed by entering a series of characters from the dialer keypad. The entered characters are transmitted as DTMF digits to a pager system station. Pager system operators use various message coding algorithms. Coding of the message to the pager system station should be performed according to the system operator manual, treating the dialer keypad in the same way as the telephone keypad. The method of message programming compliant with the POLPAGER system is presented below:

- [\*][\*] - switches the keypad to the letter mode,
- [0][\*] - return from the letter mode to the digital mode,
- [N][\*] - in the letter mode it gets the left letter of the keypad,
- [N][#] - in the letter mode it gets the right letter of the keypad,
- [N] - in the letter mode it gets the middle letter of the keypad,
- [\*] - enters a space in the digital mode,
- [0] - enters a space in the letter mode,
- [0][#][#] - the message end in the letter mode,
- [#] - the message end in the digital mode,

After entering the function, the keypad operates in the digital character entry mode. The message can consist of maximum 128 characters.

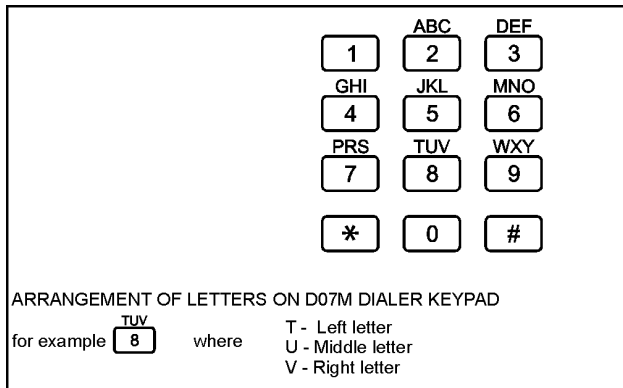

[\*] [0] [Installer Code][#] – Entrance to installer programming mode

After the command is entered, the dialer goes to the installer programming mode. The mode is signaled by the LED PROGRAM. and TEST indicators, which are on. The dialer configuration parameters are set up in the installer programming mode.

[\*] [#] Exit from programming mode

After entering the command, the dialer exits the user programming mode and enters the monitoring mode.

## INSTALLER PROGRAMMING

In this mode, the dialer configuration is set up. The installer programming mode is entered exclusively from the user programming mode and is performed after entering the command **[\*] [0] [Installer code] [#]**. After entering the mode, the dialer turns on the PROGRAM. and TEST. LED indicators. The following functions are available in the installer programming mode:

### **[\*][1][N][#] – A1 input type**

The letter [N] should be replaced by entering the digit [1],[2],[4] or [8]. After entering the function, the LED indicator, which corresponds the current active option, is on. The programmer, by depressing the suitable key (1,2,4 or 8) performs the option change. After switching on the new option, the corresponding LED indicator is automatically turned on. The exit from the function and entering the changes to the memory is performed by depressing the key [#]. The options mean as follows:

- [1]- NO/SLOW type line
- [2]- NC/SLOW type line
- [4]- NO/FAST type line
- [8]- NC/FAST type line

*Example:*

*[\*][1][2][#] programs the A1 line as the NC/SLOW type line.*

**NOTE!**

*A slow line requires a pulse longer than 2 sec. for triggering. A fast line requires a pulse longer than 0.2 sec.*

### **[\*][2][N][#] – A2 input type**

Programming identical as for the A1 input.

### **[\*][3][N][#] – A3 line type**

Programming identical as for the A1 input.

### **[\*][4][XYZ][#] – Alarm start time delay**

The time delay refers only to the A1 input line. The value entered in place of the [XYZ] characters can be from 0 to 255 and means the time delay in seconds. After entering the function, the PROGRAM LED indicator flushes. The programmer enters digits, each time a subsequent digit is entered, it is presented by the LED indicators. After entering the third digit (Z), the function should be abandoned by depressing the key [#]. When the value [XYZ]=[000] is programmed, the alarm is started immediately after recognition of the A1 alarm input triggering.

*Example:*

*[\*][4][120][#] - sets the alarm start time delay at 120 seconds*

*[\*][4][012][#] - sets the alarm start time delay at 12 seconds.*

*[\*][4][12][#] - sets the alarm start time delay at 12 seconds.*

### **[\*][5][N][#] – Dialing options 1**

When the function is entered, the LED indicator, which corresponds the currently active option, is on. By depressing the proper key [1],[2],[4] or [8], the programmer selects a new option. After switching on the new option, the corresponding LED indicator is automatically turned on. The exit from the function and storing the changes in the memory is performed by depressing the key [#]. The options mean as follows:

- [1] - DT signal waiting time 4 sec./ Don't dial the number when no DT.
- [2] - DT signal waiting time 8 sec./ Don't dial the number when no DT.
- [4] - DT signal waiting time 4 sec./ Dial the number if no DT.
- [8] - DT signal waiting time 8 sec./ Dial the number if no DT.

DT –Dial Tone

*Example:*

*[\*][5][4][#] sets the DT signal waiting time at 4 sec. and makes the dialer select the telephone number and transmit the message, despite the lack of the signal.*

### **[\*][6][N][#] – Dialing options 2**

When the function is entered, the LED indicator, which corresponds the currently active option, is on. By depressing the proper key [1],[2],[4] or [8], the programmer selects a new option. After switching on the new option, the corresponding LED indicator is automatically turned on. The exit from the function and storing the changes in the memory is performed by depressing the key [#]. The [N] digit means as follows:

- [1] - Pulse dialing (PULSE) / Detect phone pick-up .
- [2] - Pulse dialing (PULSE) / Don't detect phone pick-up.
- [4] - Tone dialing (DTMF) / Detect phone pick-up.
- [8] - Tone dialing (DTMF) / Don't detect phone pick-up .

*Example:*

*[\*][6][4][#] switches to the tone (DTMF) dialing system and sets detect telephone pick-up option on.*

### **[\*][7][N][#] – Number of rings before answer**

The letter [N] should be replaced by entering a digit from the range from 0 to 9. After the function is entered, the PROGRAM. LED indicator pulses. The programmer enters the desired parameter value in place of the letter [N], the value is automatically displayed by the LED indicators. The exit from the function and the entry of the changes into the memory is obtained by depressing the key [#]. When the value N=0 is programmed, the dialer does not answer any external calls.

*Example:*

*[\*][7][4][#] sets the external call answering to activate after recognition of four rings.*

**[\*][8][XYZ][#] – Double call function time**

The value entered in place of the characters [XYZ] must stay within the range from 0 to 255 (seconds). After entering the function, the PROGRAM. LED indicator pulses. The programmer enters the value [XYZ], each time a subsequent digit is entered, the dialer presents it on the LED indicators in the HEX system. After entering the third digit (Z), the function is abandoned by depressing the key [#]. When the value [XYZ]=[000] is programmed, the **Double Call** function is disabled, which means that each time when the dialer recognizes the pre-programmed number of rings, it hooks into the telephone line and transmits a message on the dialer status and, if applicable, occurrence of the alarm.

*Note!*

*The double call function allows other devices, which use the telephone line along with the dialer, to get priority to answer an external call. When the function is used, it is recommended to set the Double Call time value at a number from 30 to 180 seconds.*

*Example:*

*[\*][8][045][#] - sets the DC function activation time at 45 seconds.*

*[\*][8][45][#] - sets the DC function activation time at 45 seconds.*

*[\*][8][5][#] - sets the DC function activation time at 5 seconds.*

**[\*][9][1] – Recording message “A3 normal”**

Immediately after depressing the key [1], the dialer starts to record the message. The message should be recorded by speaking from the distance of about 20 cm towards the dialer keypad. After the recording time (2 seconds) has expired, the dialer automatically plays back the message. Due to a short time of recording (2 sec.), it is necessary to keep the message short, e.g. "MONITORING ENABLE" or "MONITORING ON". In case the recorded message is too silent or is significantly distorted, the recording should be repeated and the programmer should speak louder.

**[\*][9][2] – Recording message “A3 triggered”**

Immediately after depressing the key [2], the dialer starts to record the message. The message should be recorded by speaking from the distance of about 20 cm towards the dialer keypad. After the recording time (2 seconds) has expired, the dialer automatically plays back the message. Due to a short time of recording (2 sec.), it is necessary to keep the message short, e.g. "MONITORING DISABLE" or "MONITORING OFF". In case the recorded message is too silent or is significantly distorted, the recording should be repeated and the programmer should speak louder.

**[\*] [0] [New Installer code ] [#] [New Installer code] [#] – Programming of new Installer code.**

After depressing the key [0], operator has to make a double entry of the new installer code. Each time the new code has to be ended with the character [#]. When the two codes are identical, the new code is stored in the memory, otherwise a programming error is signaled and the function is abandoned. The code length must stay within the range from 4 to 8 digits. The digits of the entered code are displayed by the LED indicators.

**[\*] [#] Exit from installer programming mode**

After entering the command, the dialer abandons the installer programming mode and goes to the monitoring mode.

**TECHNICAL DATA**

Power supply voltage 11..15 Vdc  
 Supply current typical 40mA / max.100mA  
 Operating temperature range 0..50 C°  
 Weight approx. 0.27 kg  
 Dimensions (L x W x H) 215 x 95 x 27

**DRAWINGS**

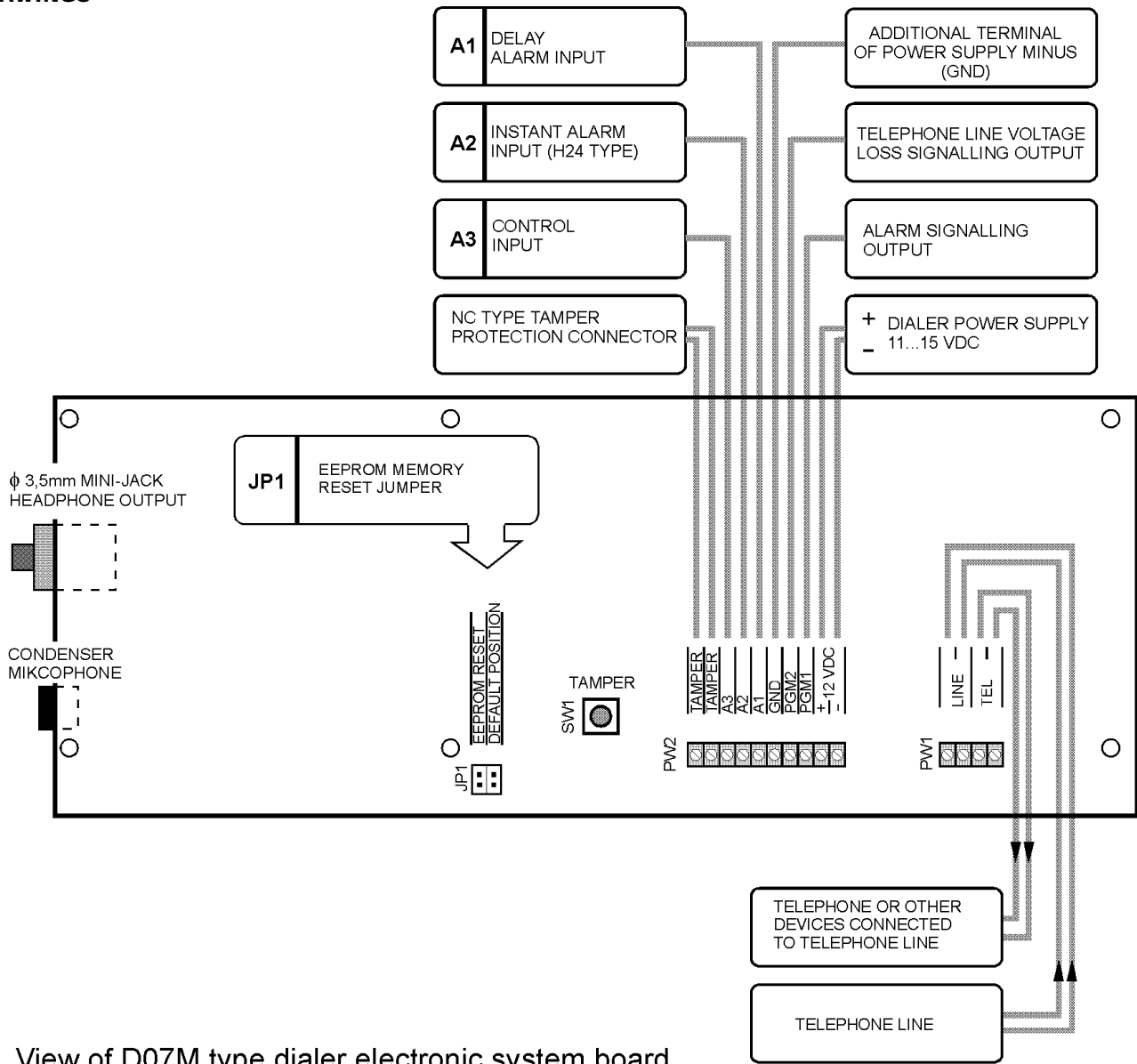

View of D07M type dialer electronic system board

