

# Serrature Universali

## *Cam locks*



ASSA ABLOY

ASSA ABLOY, the global leader  
in door opening solutions



# Serrature Universali - 90° Dx. Cam locks - 90° Rh

## Caratteristiche tecniche:

Le serrature universali ordinate con i codici della tabella sono fornite di serie:

- 2 Chiavi per serratura
- Chiave grezza (cod. PK100 57 01) intercambiabile con la linea lucchetti Europadlock
- Corpo in zama
- 4 Pistoncini
- Dado di fissaggio corpo M20x1
- Vite di fissaggio levetta M5x4
- Finitura:
  - nichelato opaco
  - ottone lucido
- Versioni:
  - Rotazione 90° dx
  - Rotazione 90° sx
  - Rotazione 180°
- Confezione: Scatola o Blister

## A richiesta:

- Speciale versione a 5 pistoncini su serrature da 20 mm. (specificare sull'ordine)
- Levetta
- Rondella di graffaggio
- Esecuzioni speciali:  
KA - KAR - KAS - MK\*\*

La confezione non comprende la levetta

\*\* Impianti MK per 9 pezzi massimo

## Features:

Cam locks ordered with the codes of the table are supplied:

- 2 Keys each cam lock
- Key blank (cod. PK100 57 01) interchangeable with Europadlock line
- Zamak body
- 4 Pins
- Body fixing nut M20x1
- Cam fixing screw M5x4
- Finish:
  - dull nickel plated
  - bright brass
- Versions
  - 90° rotation right
  - 90° rotation left
  - 180° rotation
- Packaging: Box or Blister

## Available on request:

- Special 5 pin versions for 20 mm. cam lock (specifying on the order)
- Cam
- Antislip washer
- Special arrangements:  
KA - KAR - KAS - MK\*\*

Cam not included

\*\* MK installation for 9 pcs. max.



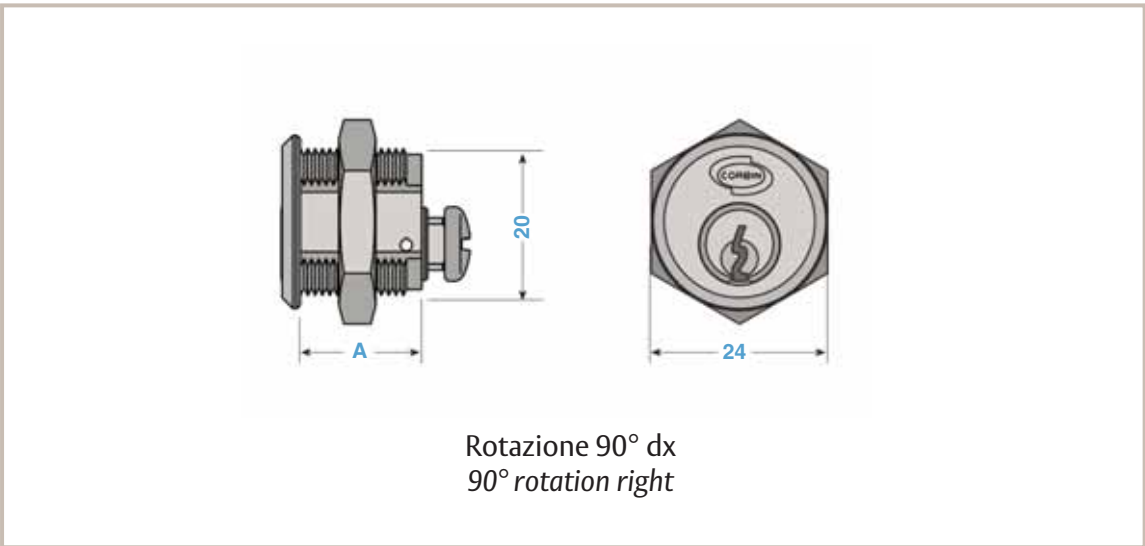

Codice / Code	A mm	Finitura / Finish			
---------------	---------	-------------------	---	---	---



Scatola / Box

PC200 15 00	16	Nichelata cromata <i>Nickel chrome plated</i>	PK100 57 01	72	24
PC200 20 00	20		PK100 57 01	81	24
PC200 25 00	25		PK100 57 01	91	24
PC200 30 00	30		PK100 57 01	101	24



Blister / Blister

PTC01 00 01	16	Nichelata cromata <i>Nickel chrome plated</i>	PK100 57 01	72	12
PTC01 00 02	20		PK100 57 01	81	12
PTC01 00 03	25		PK100 57 01	91	12
PTC01 00 04	30		PK100 57 01	101	12



Scatola / Box

PC200 15 20	16	Ottone lucido <i>Bright brass</i>	PK100 57 01	72	24
PC200 20 20	20		PK100 57 01	81	24
PC200 25 20	25		PK100 57 01	91	24
PC200 30 20	30		PK100 57 01	101	24



Blister / Blister

PTC01 00 05	16	Ottone lucido <i>Bright brass</i>	PK100 57 01	72	12
PTC01 00 06	20		PK100 57 01	81	12
PTC01 00 07	25		PK100 57 01	91	12
PTC01 00 08	30		PK100 57 01	101	12

# Serrature Universali - 90° Sx. Cam locks - 90° Lh

## Caratteristiche tecniche:

Le serrature universali ordinate con i codici della tabella sono fornite di serie:

- 2 Chiavi per serratura
- Chiave grezza (cod. PK100 57 01) intercambiabile con la linea lucchetti Europadlock
- Corpo in zama
- 4 Pistoncini
- Dado di fissaggio corpo M20x1
- Vite di fissaggio levetta M5x4
- Finitura:
  - nichelato opaco
  - ottone lucido
- Versioni:
  - Rotazione 90° dx
  - Rotazione 90° sx
  - Rotazione 180°
- Confezione: Scatola o Blister

## A richiesta:

- Speciale versione a 5 pistoncini su serrature da 20 mm. (specificare sull'ordine)
- Levetta
- Rondella di graffaggio
- Esecuzioni speciali:  
KA - KAR - KAS - MK\*\*

La confezione non comprende la levetta

\*\* Impianti MK per 9 pezzi massimo

## Features:

Cam locks ordered with the codes of the table are supplied:

- 2 Keys each cam lock
- Key blank (cod. PK100 57 01) interchangeable with Europadlock line
- Zamak body
- 4 Pins
- Body fixing nut M20x1
- Cam fixing screw M5x4
- Finish:
  - dull nickel plated
  - bright brass
- Versions
  - 90° rotation right
  - 90° rotation left
  - 180° rotation
- Packaging: Box or Blister

## Available on request:



- Special 5 pin versions for 20 mm. cam lock (specifying on the order)
- Cam
- Antislip washer
- Special arrangements:  
KA - KAR - KAS - MK\*\*

Cam not included

\*\* MK installation for 9 pcs. max.

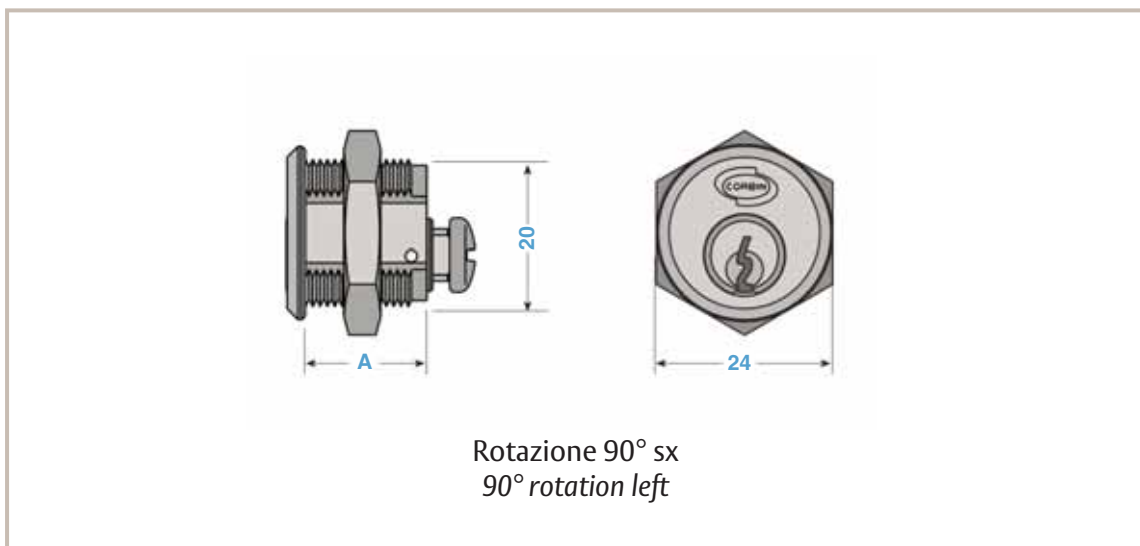



Codice / Code	A mm	Finitura / Finish			
---------------	---------	-------------------	---	---	---



Scatola / Box

PC201 15 00	16	Nichelata cromata <i>Nickel chrome plated</i>	PK100 57 01	72	24
PC201 20 00	20		PK100 57 01	81	24
PC201 25 00	25		PK100 57 01	91	24
PC201 30 00	30		PK100 57 01	101	24



Blistero / Blister

PTC01 00 09	16	Nichelata cromata <i>Nickel chrome plated</i>	PK100 57 01	72	12
PTC01 00 10	20		PK100 57 01	81	12
PTC01 00 11	25		PK100 57 01	91	12
PTC01 00 12	30		PK100 57 01	101	12



Scatola / Box

PC200 15 20	16	Ottone lucido <i>Bright brass</i>	PK100 57 01	72	24
PC200 20 20	20		PK100 57 01	81	24
PC200 25 20	25		PK100 57 01	91	24
PC200 30 20	30		PK100 57 01	101	24



Blistero / Blister

PTC01 00 13	16	Ottone lucido <i>Bright brass</i>	PK100 57 01	72	12
PTC01 00 14	20		PK100 57 01	81	12
PTC01 00 15	25		PK100 57 01	91	12
PTC01 00 16	30		PK100 57 01	101	12

# Serrature Universali - 180°

## Cam locks - 180°

### Caratteristiche tecniche:

Le serrature universali ordinate con i codici della tabella sono fornite di serie:

- 2 Chiavi per serratura
- Chiave grezza (cod. PK100 57 01) intercambiabile con la linea lucchetti Europadlock
- Corpo in zama
- 4 Pistoncini
- Dado di fissaggio corpo M20x1
- Vite di fissaggio levetta M5x4
- Finitura:
  - nichelato opaco
  - ottone lucido
- Versioni:
  - Rotazione 90° dx
  - Rotazione 90° sx
  - Rotazione 180°
- Confezione: Scatola o Blister

### A richiesta:

- Speciale versione a 5 pistoncini su serrature da 20 mm. (specificare sull'ordine)
- Levetta
- Rondella di graffaggio
- Esecuzioni speciali:  
KA - KAR - KAS - MK\*\*

La confezione non comprende la levetta

\*\* Impianti MK per 9 pezzi massimo

### Features:

Cam locks ordered with the codes of the table are supplied:

- 2 Keys each cam lock
- Key blank (cod. PK100 57 01) interchangeable with Europadlock line
- Zamak body
- 4 Pins
- Body fixing nut M20x1
- Cam fixing screw M5x4
- Finish:
  - dull nickel plated
  - bright brass
- Versions
  - 90° rotation right
  - 90° rotation left
  - 180° rotation
- Packaging: Box or Blister

### Available on request:



- Special 5 pin versions for 20 mm. cam lock (specifying on the order)
- Cam
- Antislip washer
- Special arrangements:  
KA - KAR - KAS - MK\*\*

Cam not included

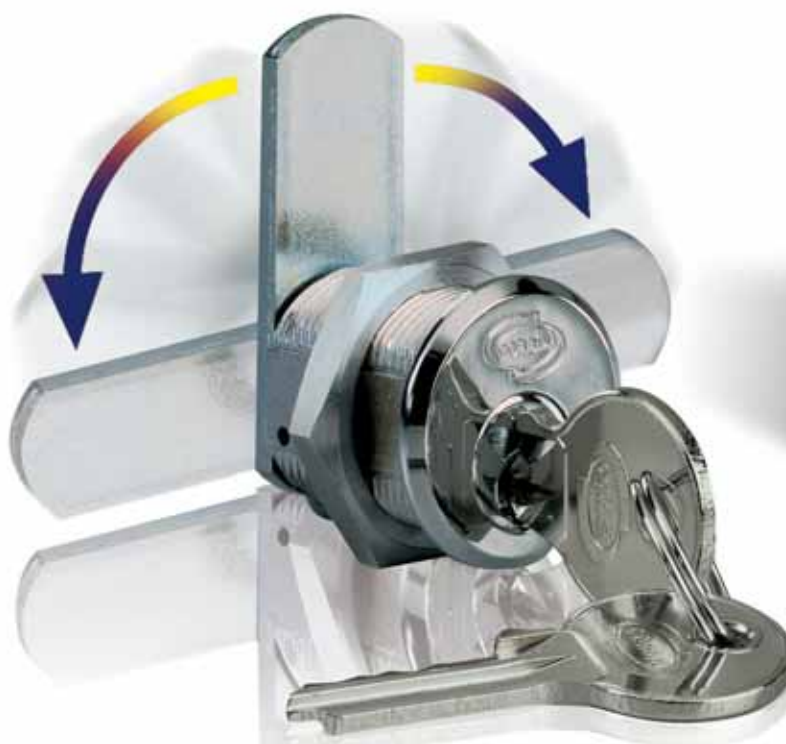
\*\* MK installation for 9 pcs. max.

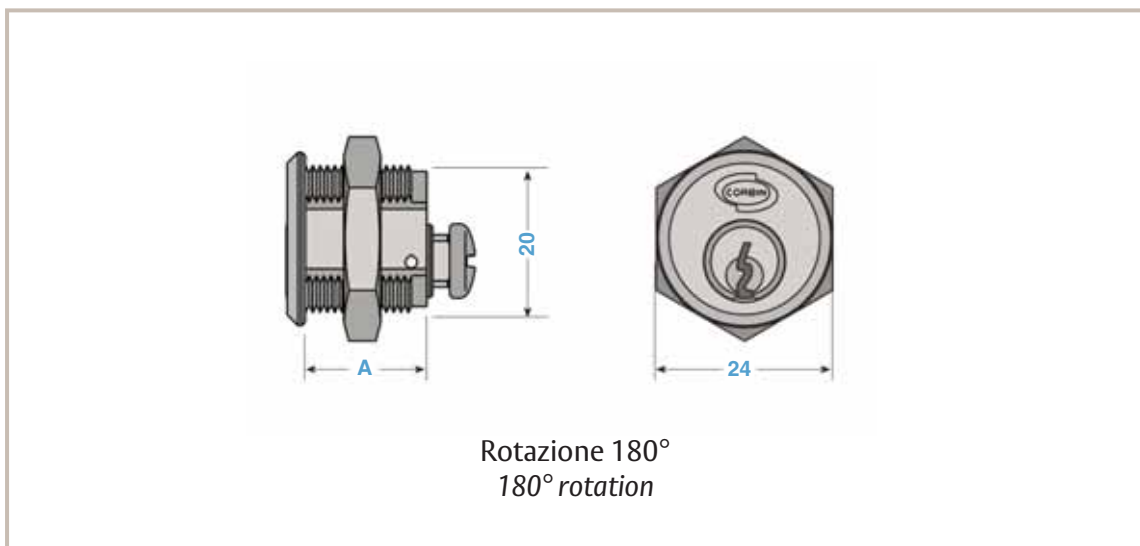



Codice / Code	A mm	Finitura / Finish			
---------------	---------	-------------------	---	---	---



Scatola / Box

PC200 15 00	16	Nichelata cromata <i>Nickel chrome plated</i>	PK100 57 01	72	24
PC200 20 00	20		PK100 57 01	81	24
PC200 25 00	25		PK100 57 01	91	24
PC200 30 00	30		PK100 57 01	101	24



Blister / Blister

PTC01 00 17	16	Nichelata cromata <i>Nickel chrome plated</i>	PK100 57 01	72	12
PTC01 00 18	20		PK100 57 01	81	12
PTC01 00 19	25		PK100 57 01	91	12
PTC01 00 20	30		PK100 57 01	101	12



Scatola / Box

PC200 15 20	16	Ottone lucido <i>Bright brass</i>	PK100 57 01	72	24
PC200 20 20	20		PK100 57 01	81	24
PC200 25 20	25		PK100 57 01	91	24
PC200 30 20	30		PK100 57 01	101	24



Blister / Blister

PTC01 00 21	16	Ottone lucido <i>Bright brass</i>	PK100 57 01	72	12
PTC01 00 22	20		PK100 57 01	81	12
PTC01 00 23	25		PK100 57 01	91	12
PTC01 00 24	30		PK100 57 01	101	12



## Chiavi grezze (ottone nichelato) Key blanks (Nickel plated brass)



30 mm



PK100 57 01



50

## Rondella di graffaggio Antislip washer

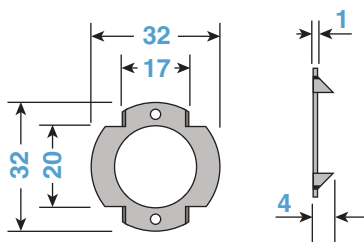

Codice / Code



PAC35 00 01

24

## Levette Cams

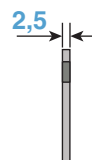
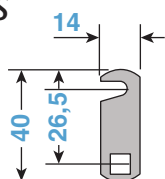

A

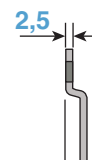

B

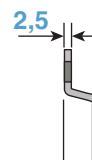

C

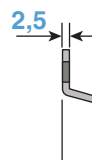

D

Codice / Code



A

PAC20 10 12

24

B

PAC20 10 13

24

C

PAC20 10 14

24

D

PAC20 10 15

24

## Leve con gancio Cams with hook

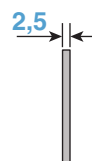
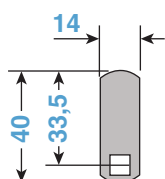

A

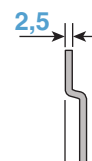

B

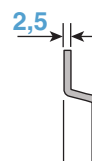

C

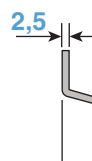

D

Codice / Code



A

PAC20 00 16

24

B

PAC20 00 17

24

C

PAC20 00 18

24

D

PAC20 00 19

24



# Impianti di cifratura speciale

## Special arrangements

**KA**

Impianto a chiave uguale (cifratura a ns. scelta)  
*Keyed alike installation (keyed to our choice)*

**KAR**

Impianto a chiave uguale (cifratura registrata)  
*Keyed alike installation (Coded keyed)*

**KAS**

Impianto a chiave uguale (cifratura uguale al campione)  
*Keyed alike installation (keyed as per sample)*

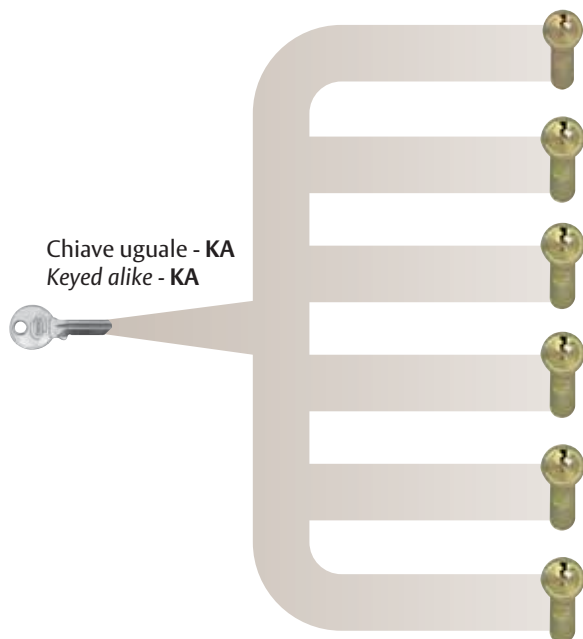

Tutte le serrature (cilindri o lucchetti) sono aperte con la stessa chiave  
*All locks (cylinders or padlocks) opened by the same key*

**MK\***

Impianto a chiave Maestra  
*Master Key installation*

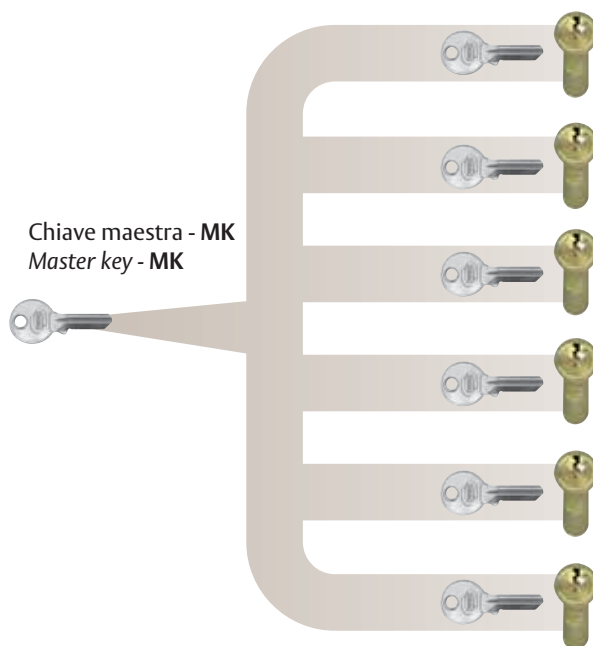

\* Impianti MK per 9 pezzi massimo / *MK installation for 9 pcs. max.*

Ogni serratura (cilindro o lucchetto) è aperta dalla propria chiave individuale  
e dalla chiave Maestra

*Each lock (cylinder or padlock) is opened by its own individual key, and the Master Key*



ASSA ABLOY Italia S.p.A.  
Via Modena 68 - 40017 San Giovanni in Persiceto (BO) Italy  
Tel. +39 051 6812411 - Fax +39 051 827486  
info@assaabloy.it - www.assaabloy.it

ASSA ABLOY is the  
global leader in door  
opening solutions,  
dedicated to satisfying  
end-user needs for  
security, safety and  
convenience.

[www.assaabloy.com](http://www.assaabloy.com)



ASSA ABLOY Italia S.p.A. si riserva di apportare in qualunque momento e senza preavviso le modifiche necessarie per migliorare ed evolvere le caratteristiche dei propri prodotti. Fotografie, illustrazioni e descrizioni sono da ritenersi indicative.  
ASSA ABLOY Italia S.p.A. reserves the right at any time, and without notice, the necessary modifications in order to improve and evolve the characteristics of their products. Photographs, illustrations and descriptions ought to be considered as indicative.

H001401/01 2008