

# GlassProtect Fibra User Manual

Updated December 6, 2022



**GlassProtect Fibra** is a wired glass break detector. Designed for indoor use. Supports connection of a third-party detector with a normally closed (NC) contact type.



The detector is compatible with [Hub Hybrid \(2G\)](#) and [Hub Hybrid \(4G\)](#). Connection to other [hubs](#), [radio signal range extenders](#), [ocBridge Plus](#), [uartBridge](#), and third-party control panels is not provided.

GlassProtect Fibra works as part of the Ajax security system, exchanging data with the hub using the secure Fibra wired protocol. The communication range is up to 2,000 m when connected via twisted pair U/UTP cat.5.

GlassProtect Fibra is part of the wired Fibra devices line. The installation, sale, and configuration of these devices are performed only by accredited Ajax partners.

[Buy GlassProtect Fibra](#)

## Functional elements

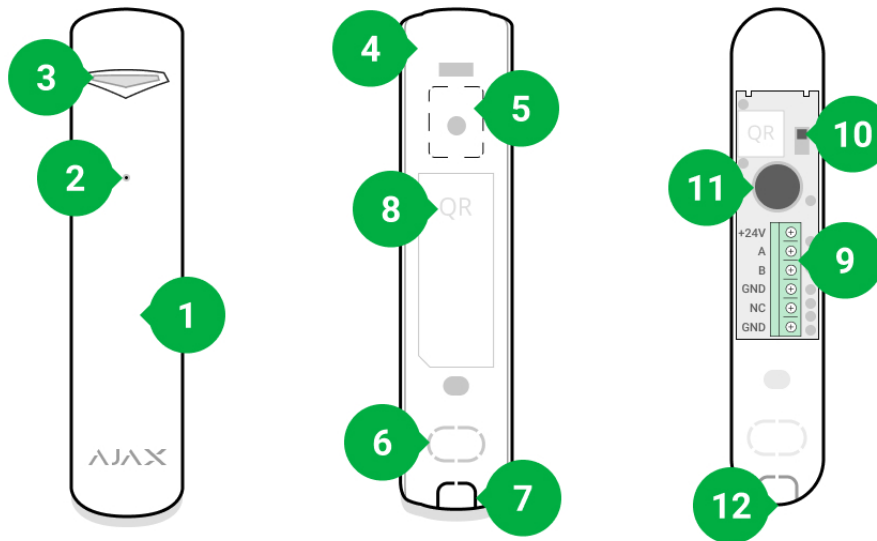

1. GlassProtect Fibra glass break detector.
2. Detector microphone slot.
3. LED indicator.
4. Detector enclosure rear panel. Used as a fastener.
5. Perforated part of the enclosure. Triggers a tamper in case of any attempt to detach the detector from the surface. Do not break it off.
6. Perforated part of enclosure for wire output through the wall.
7. Perforated part of enclosure for wire output underneath the detector.
8. Terminal strip for detector connection.
9. QR code and ID (serial number) of the hub. Used to connect the device to the Ajax security system.
10. Tamper button.
11. Break detector microphone.
12. The hole for attaching the rear panel with a screw.

## Operating principle

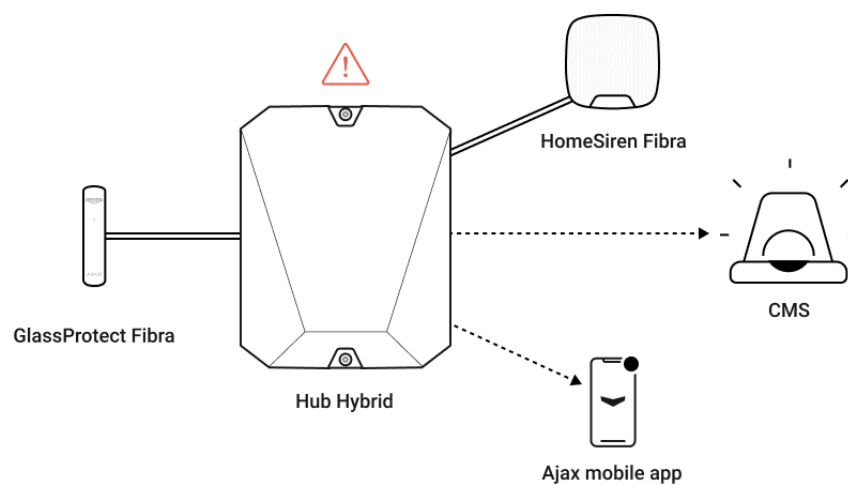

**GlassProtect Fibra** is a wired glass break detector. It responds to glass breaking using a built-in electret microphone. The detector's microphone using the DualTone digital algorithm only responds to sound vibrations characteristic of the sound of glass breaking, cutting off false alarms.

In the armed mode, the detector instantly transmits an alarm signal to the hub when it detects a break. The hub activates connected sirens, runs scenarios, and notifies users and the security company.

Users will know where a glass break has been detected. The notifications contain the name of the hub (name of the guarded facility), the name of the device, the type of alarm, and the virtual room to which the detector is assigned.

### How Ajax notifies users of alarms

### More about Ajax break detectors

## Protection from false alarms

The detector uses DualTone – a two-stage algorithm to exclude false alarms. To register a break, the detector must record a dull (low-frequency) sound of an impact and then a ringing (high-frequency) sound of falling fragments in 1.5 seconds. Owing to this algorithm, the detector does not respond to the barking of dogs or cars passing by the protected facility.



GlassProtect Fibra will not react on a break if a film is glued to the glass: anti-shock, sun-protective, decorative, or other. To detect the break of such glass, we recommend using detectors with a shock sensor: DoorProtect Plus Fibra or DoorProtect Plus.

## Fibra data transfer protocol

The detector uses **Fibra technology** to transmit alarms and events. This is a wired data transfer protocol to provide fast and reliable two-way communication between the hub and the connected devices. Using the bus connection method, Fibra delivers alarms and events instantly, even if 100 devices are connected to the system.

Fibra supports floating key block encryption and verifies each communication session with devices to prevent sabotage and spoofing. To monitor connection with the system devices and display their statuses in the Ajax apps, the protocol involves regular device polling by the hub with an interval of 12 to 300 seconds.

[Learn more](#)

## Connection of a third-party wired detector

A third-party wired detector with a normally closed (NC) contact type can be connected to GlassProtect Fibra. This can be any detector: motion, opening, or vibration.

GlassProtect Fibra will not power the third-party detector. The detector should be connected separately. To learn the type and input voltage of the third-party detector, refer to the device documentation or contact the manufacturer's technical support.

[How to connect a wired detector](#)

## Sending events to the Central Monitoring Station (CMS)

The Ajax security system can transmit events and alarms to the [PRO Desktop](#), monitoring app as well as the Central Monitoring Station (CMS) via **SurGard (Contact ID)**, **SIA DC-09 (ADM-CID)**, **ADEMCO 685**, and other proprietary protocols. A list of supported protocols [available here](#).

[Which CMSs can the Ajax security system be connected to?](#)

## GlassProtect Fibra can transmit the following events:

1. Glass break sensor alarm.
2. Alarm of connected third-party detector.
3. Tamper alarm/recovery.
4. Hub connection loss/restoration.
5. Temporary activation/deactivation of the detector.
6. Unsuccessful attempt to arm the security system (with the system integrity check enabled).

When an alarm is received, the operator of the security company monitoring station knows what happened and where to send the fast response team. Addressability of Ajax devices allows sending not only events but also the type of the device, the name, group, and virtual room assigned to it to the PRO Desktop and to the CMS. The list of transmitted parameters may differ depending on the type of the CMS and the selected communication protocol.



The device ID, loop (zone) number, and Fibra line number can be found in device states in the Ajax app. The **Device Number** corresponds to the loop (zone) number.

## Selecting the installation site

GlassProtect Fibra is mounted on a vertical surface with the bundled screws. All the necessary holes for fastening in the enclosure have already been made. The detector is intended for indoor installation only.

**When choosing a location for GlassProtect Fibra, consider the parameters that affect the correct operation of the detector:**



- Fibra signal strength.
- Cable length for connecting the detector to the hub.
- Cable length for connecting a third-party detector.
- Glass break detection zone.

Consider the placement recommendations when designing your facility's security system. The security system should be designed and installed by professionals. The list of authorized Ajax partners is [available here](#).

## Do not install GlassProtect Fibra:

- Outdoors. This can lead to false alarms and detector failure.
- Close to sirens and speakers. This can lead to false alarms of the break detector.
- In places with fast air circulation – for example, near fans, open windows, or doors. This can lead to false alarms of the break detector.
- In places where objects or structures can interfere with the passage of sound to the detector. For example, in places where the curtains will be between the window and the GlassProtect Fibra. This may prevent the detector from registering glass breakage.
- Inside premises with temperature and humidity outside the permissible limits. This could damage the detector.

## Fibra signal strength

The Fibra signal strength is determined by the number of undelivered or corrupted data packages over a certain period. The icon  in the **Devices**  tab in the Ajax apps indicates the signal strength:

- **Three bars** – excellent signal strength.
- **Two bars** – good signal strength.
- **One bar** – low signal strength, stable operation is not guaranteed.
- **Crossed out icon** – no signal, stable operation is not guaranteed.

### The following factors affect the signal strength:

- The number of devices connected to one Fibra line.
- Cable length and type.

- The correctness of the wire connections to the terminals.



Check the Fibra signal strength before final installation of the detector. If the signal strength is as low as one or zero bars, we cannot guarantee stable operation of the device.

## Detection zone

When choosing a place to install the detector, run a Detection zone test to check the operation of the device and determine the sector in which the detector registers glass breaking.

The location of the detector determines the area to be monitored and the effectiveness of the security system. When deciding where to install the detector, consider the directivity of the microphone and the presence of obstacles interfering with the microphone operation.

The microphone of the detector identifies glass breaks at a distance of up to 9 meters. To detect a break, the detector should be positioned at an angle of up to 90 degrees to the window or windows.

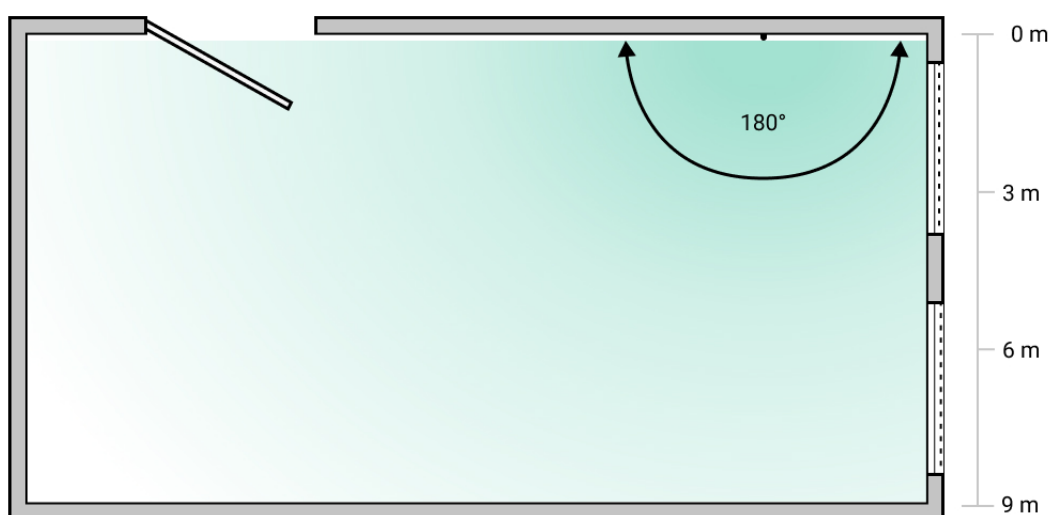

Detection angle of the break detector

## Designing

To correctly install and configure security system devices, it is important to design the security system properly. The design must consider the number and

types of devices at the object, their exact location and installation height, the length of Fibra wire lines, the type of cable used, and other parameters. Tips for designing wired Fibra systems are available [in this article](#).

## Topologies

Currently, Ajax security systems support two topologies: **Beam (Radial wiring)** and **Ring**.



Connecting devices using a **Ring** topology will be implemented in the next OS Malevich updates. Hardware update of Hub Hybrid is not required.

**Beam connection (Radial wiring)** occupies one bus output of the hub. In the event of a line break, only the segment that remains physically connected to the hub will function. All devices connected after the breakpoint will lose connection with the hub.



**Ring connection** occupies two bus outputs of the hub. If the ring breaks in one place, no device will be deactivated. The ring reconfigures into two lines, which continue to operate normally. Users and the security company will receive notification about the break.



Beam (Radial wiring)

Ring



Occupies one bus output of the hub.  
Up to 8 lines on the same hub.  
Up to 2,000 m of wired communication for the same line.  
A termination resistor is installed at the end of the line.

Occupies two bus outputs of the hub.  
Up to 4 rings on the same hub.  
Up to 500 m of wired communication for the same ring.  
No termination resistor is installed at the end of the line.

Both topologies can be used on the same hub. For example, you can use 2 ring and 4 beam (Radial wiring) connections on the same control panel.

Different types of devices can be connected to a single Fibra line. For example, you can connect opening detectors, motion detectors with photo verification support, sirens, and keypads to the same line.

**The devices are connected to the Fibra line one by one, as shown in the diagram below. Branching of lines is not allowed.**

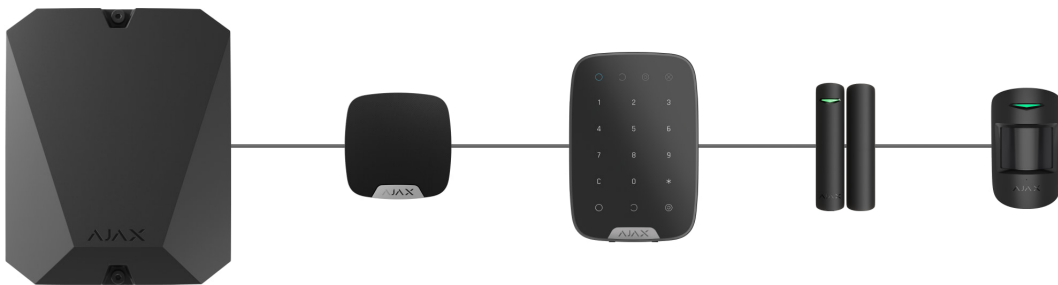

When using the **Beam (Radial)** topology, be sure to install a 120 Ohm terminating resistor at the end of the line (included in the hub kit). The termination resistor is connected to the signal terminals of the last detector on the line.

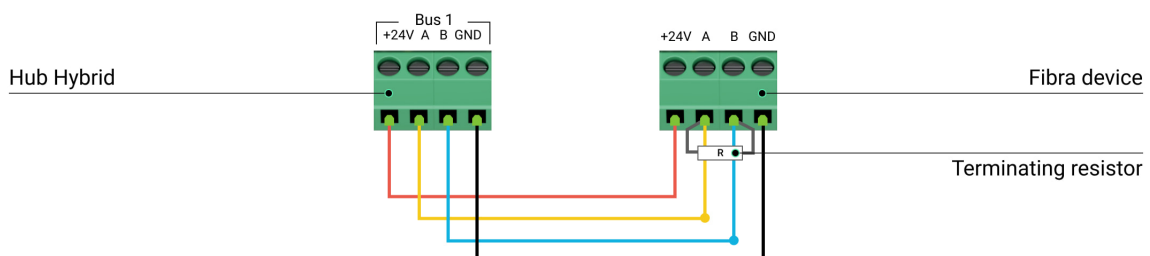

## Cable length and type

The maximum range of a wired connection using the **Beam (Radial)** topology is 2,000 meters, and using the **Ring** topology – 500 meters.



Recommended cable types:

- U/UTP cat.5 4 × 2 × 0.51. The conductor material is copper.
- Signal cable 4 × 0.22. The conductor material is copper.

If you use a different type of cable, the communication range for wired connections may vary. No other types of cables have been tested.

## Verification using a calculator

To make sure that the project is calculated correctly, and the system will work in real practice, we have developed a [communication range calculator of Fibra lines](#). The calculator helps to check the quality of communication and cable length for wired Fibra devices with the selected configuration at the system design stage.

## Additional information

The maximum current that Hub Hybrid can supply in total for all Fibra lines is 600 mA. The total current consumption of the devices in the system depends on the type of cable, its length, the type of connected device, the quality of the connection of conductors, and other factors. Therefore, after selecting devices, we recommend verifying the project using the [Fibra calculator](#).

You can connect 100 devices to Hub Hybrid by default.

## Preparing for installation

### Cable arrangement

When preparing to lay cables, check the electrical and fire safety regulations in your area. Strictly follow these standards and regulations.

It is safest to route cables inside walls, floors, and ceilings: this way they will be invisible and unavailable for intruders. It also ensures their greater durability: the cable will be affected by fewer external factors that affect the natural wear of the conductor and its insulating layer.

As a rule, security system cables are laid during the construction or repair stage, and after wiring at the object.

If it is impossible to install cables inside the walls, route them so that the cable is protected and hidden from prying eyes. For example, in a cable tray or a protective corrugated pipe. It is desirable to hide such channels. For example, behind the furniture.

We recommend using protective pipes, cable conduits, or corrugated pipes to protect cables, regardless of whether they are routed inside the wall or not. The cables should be arranged carefully: no sagging, tangling, or twisting is allowed.

Consider the places of possible signal interference. If the cable is routed near motors, generators, transformers, power lines, control relays, and other sources of electromagnetic interference, use twisted-pair cable in these areas.

## Cable routing

When laying cables for a security system, consider not only the general requirements and rules for electrical installation work but also the specific installation features of each device: installation height, mounting method, how the cable is inserted into the enclosure, and other parameters.

Before installation, we recommend you read the [choosing an installation location](#) section of this manual, as well as the manual for a third-party wired detector (if needed). If you have questions about the operation of a third-party wired detector, please contact the technical support of the manufacturer of this device.

Try to avoid any deviations from the security system design. Violation of the basic installation rules and the recommendations of this manual may lead to incorrect operation of GlassProtect Fibra.

Check the cables for bends and physical damage before routing. Replace the damaged cables.

Signal cables for the security system devices must be laid at a distance of at least 50 cm from the power cables when laying parallel, and, if they intersect, at a 90° angle.

Observe the permissible bending radius of the cable. The bending radius is specified by the manufacturer in the cable specifications. Otherwise, you risk damaging or breaking the conductor.

Fibra devices are connected to the line one by one. Branching of lines is not allowed.

## Preparing cables for connection

Remove the insulating layer of the cable and strip the cable with a special insulation stripper. It strips the cable properly without damaging the conductor. The ends of the wires that will be inserted into the detector's terminals should be tinned. This ensures reliable connection and protects the conductor from oxidation.

Do not use special sleeves to crimp the wire ends and connect them to the detector. GlassProtect Fibra enclosure is not designed for crimped wire connection.

## Installation and connection



Before installing GlassProtect Fibra, make sure that you have selected the optimal detector location and that it meets the requirements of this manual. Cables must be hidden and located in a place that is difficult for burglars to access to reduce the likelihood of sabotage. Ideally, the cables should be set into the walls, floor, or ceiling. Before final installation, run [detection zone test](#) and **Fibra signal strength test**.

When connecting to the terminals of the device, do not twist the wires together, but solder them. The ends of the wires that will be inserted into the terminals should be tinned. This will ensure a reliable connection.

**Follow safety procedures and regulations for electrical installation work.** Do not use special sleeves to crimp the wire ends and connect them to the detector. GlassProtect Fibra enclosure is not designed for crimped wire connection.

## Connection of GlassProtect Fibra to the hub

1. Turn off the hub. Disconnect the external power and the hub backup battery.

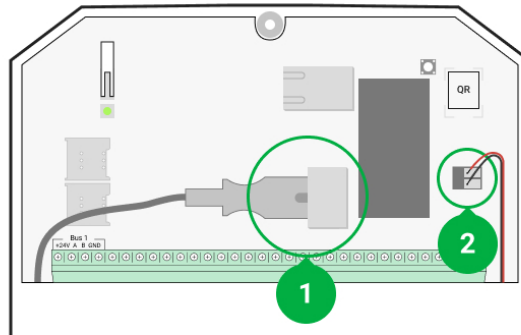

- 1 – External power.
- 2 – Backup battery.

2. Plug the detector connection cable into the hub enclosure. Connect the wires to the desired hub line.

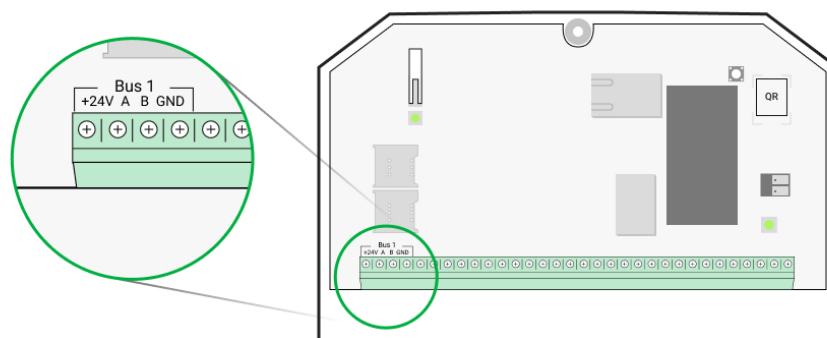

- +24V** – power terminal 24 V $\overline{=}$ .
- A, B** – signal terminals.
- GND** – ground.

3. Disassemble GlassProtect Fibra detector.

4. Remove the rear panel from the detector and carefully break out the perforated part to lead the cables out.

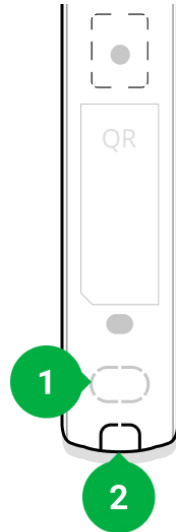

- 1 – For cable output through the wall.
- 2 – For cable output from the bottom of the detector.

5. If the break detector is not the last in the connection line, prepare a second cable in advance. The ends of the wires of the first and second cables that will be inserted into the terminals of the device should be tinned and soldered together.
6. Run the cable from the hub into the detector's enclosure through the hole made.
7. Connect the wires to the terminals according to the scheme below. Follow the polarity and connection order of the wires. Securely fasten the cable to the terminals.

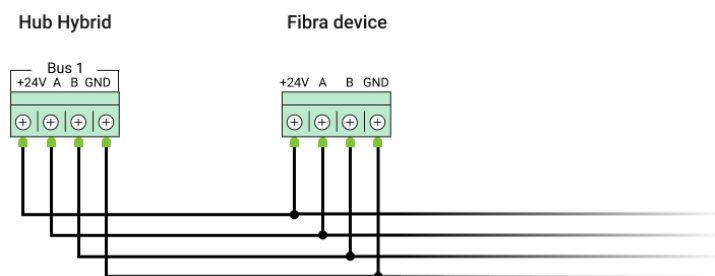

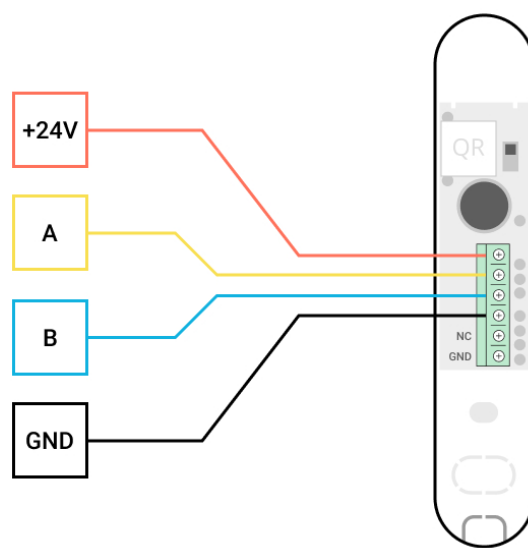

**+24V** – power terminal 24 V<sub>DC</sub>.

**A, B** – signal terminals.

**GND** – ground.

8. If the detector is the last in the line, install a termination resistor in case of **Beam (Radial) connection** by connecting it to the signal terminals of the device. For the **Ring connection**, no termination resistor is needed.



If possible, we recommend connecting devices using the **Ring** topology (hub–device–hub). This improves the antisabotage protection of the system.

9. Temporarily secure the detector using a double-sided adhesive tape or other temporary fasteners at the chosen installation location. This is necessary to run the detector tests.
10. Connect the backup battery and external power supply to the hub. Turn on the hub.
11. Add GlassProtect Fibra to the system.
12. Perform a test of Fibra signal strength. The recommended signal strength is two or three bars. If the signal strength is one or zero bars, check the connection correctness and the cable integrity.
13. Perform a Detection zone test. The maximum range of break detection is 9 meters. If the detector did not respond to break during the test in 5 out of 5 cases, it should be installed in a different location.

## How to test the device operation

14. If the detector passes the tests, fix it with bundled screws at two fixing points (one of them – is in the perforated part of the mount above the tamper). When using other fasteners, make sure they do not damage or deform the mounting panel.



Double-sided tape can be used for temporary attachment. The device attached by adhesive tape may come unstuck from the surface at any time. As long as the device is taped, the tamper will not be triggered when the detector is detached from the surface.

15. Fix the detector on the rear panel with the bundled screw.

## Adding to the system



The detector is compatible only with [Hub Hybrid \(2G\)](#) and [Hub Hybrid \(4G\)](#). Only authorized partners can add and configure Fibra devices in [Ajax PRO apps](#).

[Types of accounts and their rights](#)

## Before adding GlassProtect Fibra

1. Install the [Ajax PRO app](#). Create an [account](#) if you don't already have one.
2. Add a hub compatible with the detector to the app, set the necessary settings, and create at least one [virtual room](#).
3. Make sure that the hub is on and has Internet access via Ethernet and/or mobile network. You can do this in the Ajax app or by looking at the LED on the hub board. It should light up white or green.
4. Make sure the hub is not armed and does not start updates by checking its status in the [Ajax app](#).
5. Make sure the detector is physically connected to the hub.



# How to add GlassProtect Fibra

## To add a detector manually

1. Open the [Ajax PRO app](#). Select the hub you want to add GlassProtect Fibra to.
2. Go to the **Devices**  tab and click **Add device**.
3. Set the name of the detector.
4. Scan or enter the QR code. The QR code is located on the detector enclosure and its packaging.
5. Select a virtual room and a security group if the [group mode](#) is enabled.
6. Press **Add**.

## To add a detector automatically

1. Open the [Ajax PRO app](#). Select the hub you want to add GlassProtect Fibra to.
2. Go to the **Devices**  tab and click **Add device**.
3. Select **Add all bus devices**. The hub will scan all Fibra lines. After scanning, all devices physically connected to the hub will be displayed in the **Devices** tab. The order of the devices will depend on which hub line they are connected to.

By default, the device name includes the detector name and its identifier. To pair the detector to the hub, edit the detector's name, and add it to a room and a group if the [Group mode](#) is enabled.

To check which detector you actually deal with, use any of the following methods: LED indication or detector triggering.

### Method 1: via LED indication.

In the list of available devices to add, click on any item. The LED of this detector will start flashing after you press it. This way, you'll know exactly which detector you're adding, how to name it, and which room and group it should be connected to.

## To add a detector:

1. Select the device from the list.
2. Create a name.
3. Specify a room and a security group (if the Group mode is enabled).
4. Press **Add**. If the detector connects to the hub successfully, it will disappear from the list of available detectors.

## Method 2: by detector alarm.

Enable the **Add Detectors by Alarm** option above the list of detectors.

Trigger an alarm by simulating breaking of glass:

1. Hit the glass with your fist without breaking it. If the detector microphone catches a low-frequency sound, the LED will flash.
2. Within 1.5 seconds after the impact, simulate the high-frequency sound of glass breaking, for example, by tapping a metal object against a glass.
3. As soon as the detector reads the sound, it will turn off the LED for a second.

When triggered, the detector will move to the top of the list in the **Triggered devices** category. The detector will stay in this category for 5 seconds, after which it will move back to the bus category.

## To add a detector:

1. Select the device from the list.
2. Create a name.
3. Specify a room and a security group (if the Group mode is enabled).
4. Press **Add**. If the detector connects to the hub successfully, it will disappear from the list of available detectors.



Device statuses updating depends on the **Jeweller/Fibra** settings, the default value is 36 seconds.

If you fail to add the detector, check wire connection and try again. If the hub already has the maximum number of devices added (for Hub Hybrid, the default is 100), you will get an error notification when you add one.

GlassProtect Fibra only works with one hub. When connected to a new hub, the detector stops sending commands to the old one. Once added to a new hub, GlassProtect Fibra is not removed from the list of devices of the old hub. This must be done through the Ajax app.

## Connection of a third-party wired detector

Any type of wired detector with a normally closed (NC) contact type: motion, opening, vibration can be connected to the GlassProtect Fibra detector – using terminals.

GlassProtect Fibra cannot power the third-party detector. The detector should be connected separately. To learn the type and input voltage of the third-party detector, refer to the device documentation or contact the manufacturer's technical support.

We recommend installing the third-party detector at a distance not more than 1 meter: increasing the wire length adversely affects the connection quality between the detectors.

### **To connect a third-party wired detector:**

1. Turn off the hub.
2. Disconnect the external power and the hub backup battery.

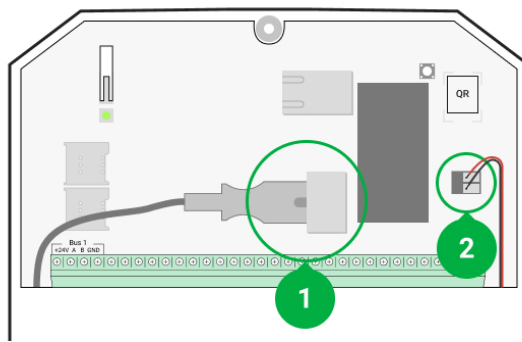

- 1 – External power.
- 2 – Backup battery.

3. Remove the front panel of GlassProtect Fibra.
4. Run the cable from the wired detector into GlassProtect Fibra enclosure.
5. Connect the wired detector to GlassProtect Fibra terminals.

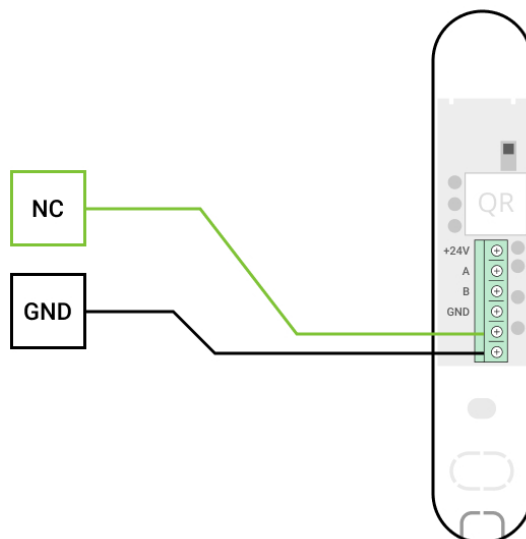

- NC** – connection terminal.
- GND** – ground.



6. Connect the backup battery and external power supply to the hub. Turn on the hub.
7. In settings of GlassProtect Fibra, enable the **External contact** option.
8. Check operation of the connected wired detector.

## Functionality testing

The Ajax security system has several tests for choosing the right installation place for the devices. Tests do not start straight away but not later than over a single “hub – device” ping period.

For GlassProtect Fibra, **Fibra signal strength test** and **detection zone test** are available. The signal strength test allowing determines the strength and stability of the signal at the installation site of the device, and the detection zone test checks how the detector reacts on alarms.

### To run a test in the Ajax app

1. Select the desired hub if you have several of them or if you use the [Ajax PRO app](#).
2. Go to the **Devices**  menu.
3. Select **GlassProtect Fibra**.
4. Go to the GlassProtect Fibra settings by clicking on the gear icon .
5. Select a test:
  1. **Fibra Signal Strength Test.**
  2. **Detection Zone Test.**
6. Perform the test following the prompts of the app.

### How to test the break detector









1. Start a detection zone test.
2. Hit the glass (without breaking it) or another surface with your fist. If the detector microphone catches a low-frequency sound, the LED will flash.
3. Within 1.5 seconds after the first impact, simulate the high-frequency sound of glass breaking by tapping a metal object against a glass or by dropping keys onto floor tiles.
4. As soon as the detector reads the sound, it will turn off the LED for a second. This means that the alarm on break is registered.





You can also play this [audio file](#) to imitate the breaking of glass.

# Icons

The icons display some of GlassProtect Fibra states. You can check them in the Ajax app in the **Devices**  tab.

Icon	Value
	Fibra signal strength – displays the signal strength between the hub and the detector. <a href="#">Learn more</a>
	The detector operates in the <b>Always active</b> mode. <a href="#">Learn more</a>
 	Delay When Entering and/or Leaving enabled. The delay applies only to the connected third-party wired detector. <a href="#">Learn more</a>
	GlassProtect Fibra will work when the <b>Night mode</b> is enabled. <a href="#">Learn more</a>
	GlassProtect Fibra has detected a glass break.
	The external contact of GlassProtect Fibra detector (a third-party wired detector) is on. <a href="#">Learn more</a>
	GlassProtect Fibra is temporarily deactivated. <a href="#">Learn more</a>
	GlassProtect Fibra has been deactivated because the number of alarms was exceeded. <a href="#">Learn more</a>

	<p>GlassProtect Fibra has been deactivated by timer.</p> <p><a href="#">Learn more</a></p>
	<p>GlassProtect Fibra tamper triggering events are temporarily deactivated.</p> <p><a href="#">Learn more</a></p>

## States

The states include information about the device and its operating parameters. GlassProtect Fibra states can be found in the Ajax app:

1. Go to the **Devices**  tab.
2. Choose GlassProtect Fibra from the list.

Parameter	Value
Temperature	<p>Detector temperature. Measured on the processor and changes gradually.</p> <p>Acceptable error between the value in the app and the room temperature: 2–4°C.</p> <p>The value is updated as soon as the detector identifies a temperature change of at least 1°C.</p>
Fibra Signal Strength	<p>The signal strength between the hub and the detector. Recommended values: 2–3 bars.</p> <p>Fibra is a wired protocol for transmitting Fibra device events and alarms.</p> <p><a href="#">Learn more</a></p>
Connection via Fibra	<p>The status of connection between the hub and the detector:</p> <ul style="list-style-type: none"> <li>• <b>Online</b> – the detector is connected to the hub, the connection is stable.</li> </ul>

	<ul style="list-style-type: none"> <li>• <b>Offline</b> — the detector has lost connection with the hub. Check the detector connection to the hub.</li> </ul>
Bus Voltage	Displays the voltage value at the detector.
Lid	<p>The status of the detector's tamper that responds to detachment or opening of the enclosure:</p> <ul style="list-style-type: none"> <li>• <b>Open</b> — detector enclosure is open. Check the integrity of the detector enclosure.</li> <li>• <b>Closed</b> — detector enclosure is closed. Normal state.</li> </ul> <p><a href="#"><u>Learn more</u></a></p>
Sensitivity	<p>Break detector sensitivity.</p> <ul style="list-style-type: none"> <li>• Low.</li> <li>• Normal (default).</li> <li>• High.</li> </ul> <p>The sensitivity level is selected based on the results of the <a href="#"><u>detection zone test</u></a>.</p> <p>If during the test the detector doesn't react to break in 5 cases out of 5, the sensitivity should be increased.</p>
Delay When Entering, sec	<p>Delay time when entering: 5 to 120 seconds.</p> <p>Delay when entering (alarm activation delay) is the time the user has to disarm the security system after entering the secured area.</p> <p><b>The Delay When Entering in GlassProtect Fibra only applies to the connected wired detector.</b></p> <p><a href="#"><u>Learn more</u></a></p>
Delay When Leaving, sec	Delay time when leaving: 5 to 120 seconds.



	<p>Delay when leaving (arming delay) is the time the user has to leave the secured area after arming.</p> <p><b>The Delay When Leaving in GlassProtect Fibra only applies to the connected wired detector.</b></p> <p><a href="#"><u>Learn more</u></a></p>
<p>Night Mode Delay When Entering, sec</p>	<p>Delay time when entering in the <b>Night Mode</b>: 5 to 120 seconds.</p> <p>Delay when entering (alarm activation delay) is the time the user has to disarm the security system after entering the premises.</p> <p><b>The Delay When Entering in GlassProtect Fibra only applies to the connected wired detector.</b></p> <p><a href="#"><u>What Is Delay When Entering</u></a></p>
<p>Night Mode Delay When Leaving, sec</p>	<p>Delay time when leaving in the <b>Night Mode</b>: 5 to 120 seconds.</p> <p>Delay when leaving (arming delay) is the time the user has to leave the premises after arming.</p> <p><b>The delays for GlassProtect Fibra only apply to the connected wired detector.</b></p> <p><a href="#"><u>What Is Delay When Leaving</u></a></p>
<p>External Contact</p>	<p>Status of the external detector connected to GlassProtect Fibra:</p> <ul style="list-style-type: none"> <li>• <b>Disconnected</b> – external contact is disconnected (option disabled in the app).</li> <li>• <b>Open</b> – external contact is enabled. The third-party detector is in the open state.</li> <li>• <b>Closed</b> – the external contact is enabled. The third-party detector is in the closed state.</li> </ul>
<p>Always Active</p>	<p>If active, the detector is always in the armed mode and notifies of alarms.</p>

	<p><a href="#"><u>Learn more</u></a></p>
Temporary Deactivation	<p>Shows the status of the device temporary deactivation function:</p> <ul style="list-style-type: none"> <li>• <b>No</b> – the device operates in normal mode and transmits all events.</li> <li>• <b>Lid only</b> – the hub administrator has disabled notifications about triggering of the device tamper.</li> <li>• <b>Entirely</b> – the hub administrator has entirely excluded the detector from the system. The device does not follow system commands and does not report alarms or other events.</li> <li>• <b>By number of alarms</b> – the device is automatically disabled by the system when the number of alarms is exceeded. The feature is configured in the Ajax PRO apps.</li> <li>• <b>By timer</b> – the device is automatically disabled by the system when the recovery timer expires. The feature is configured in the Ajax PRO apps.</li> </ul> <p><a href="#"><u>Learn more</u></a></p>
Firmware	Detector firmware version.
Device ID	Device identifier. Also available on the QR code on the detector enclosure and the packaging.
Device No.	Device number. This number is transmitted to the CMS in case of an alarm or event.
Bus No.	The number of the Fibra line the device is connected to.

## Settings

To change GlassProtect Fibra detector settings in the Ajax app:

1. Go to the **Devices** tab .
2. Choose GlassProtect Fibra from the list.

3. Go to **Settings** by clicking on the gear icon .

4. Set the parameters.

5. Click **Back** to save the new settings.

Setting	Value
Name	<p>Detector name. Displayed in the list of hub devices, text of SMS and notifications in the events feed.</p> <p>To change the detector name, click on the field.</p> <p>The name can contain up to 12 Cyrillic characters or up to 24 Latin characters.</p>
Room	<p>Selecting the virtual room to which GlassProtect Fibra is assigned.</p> <p>The room name is displayed in the text of SMS and notifications in the events feed.</p> <p><b><u><a href="#">Learn more</a></u></b></p>
Delay When Entering, sec	<p>Selecting delay time when entering: 5 to 120 seconds.</p> <p>Delay when entering (alarm activation delay) is the time the user has to disarm the security system after entering the premises.<b>The Delay When Entering in GlassProtect Fibra only applies to the connected wired detector.</b></p> <p><b><u><a href="#">What Is Delay When Entering</a></u></b></p>
Delay When Leaving, sec	<p>Selecting delay time when leaving: 5 to 120 seconds.</p> <p>Delay when leaving (arming delay) is the time the user has to leave the premises after arming.<b>The Delay When Leaving in GlassProtect Fibra only applies to the connected wired detector.</b></p> <p><b><u><a href="#">What Is Delay When Leaving</a></u></b></p>

<p>Night Mode Delay When Entering, sec</p>	<p>Delay time when entering in <b>Night Mode</b>: 5 to 120 seconds.</p> <p>Delay when entering (alarm activation delay) is the time the user has to disarm the security system after entering the premises.</p> <p><b>The Delay When Entering in GlassProtect Fibra only applies to the connected wired detector.</b></p> <p>The setting is displayed if the option <b>Arm in Night Mode</b> is enabled.</p> <p><b><u>What Is Delay When Entering</u></b></p>
<p>Night Mode Delay When Leaving, sec</p>	<p>Delay time when leaving in the <b>Night Mode</b>: 5 to 120 seconds.</p> <p>Delay when leaving (arming delay) is the time the user has to leave the premises after arming.</p> <p><b>The delays for GlassProtect Fibra only apply to the connected wired detector.</b></p> <p>The setting is displayed if the option <b>Arm in Night Mode</b> is enabled.</p> <p><b><u>What Is Delay When Leaving</u></b></p>
<p>Arm in Night Mode</p>	<p>If the option is enabled, the detector switches to armed mode when the <b>Night Mode</b> is used.</p> <p><b><u>What is Night Mode</u></b></p>
<p>Alarm LED indication</p>	<p>Adjusts flashing of the detector's LED indicator in case of an alarm or tamper triggering:</p> <ul style="list-style-type: none"> <li>• <b>Enabled</b> – indication is enabled.</li> <li>• <b>Disabled</b> – indication is disabled and will not notify of alarms or tamper triggering.</li> </ul>
<p>Sensitivity</p>	<p>Sensitivity level of the detector's microphone. There are three sensitivity levels:</p> <ul style="list-style-type: none"> <li>• Low.</li> </ul>

	<ul style="list-style-type: none"> <li>• Normal (default).</li> <li>• High.</li> </ul> <p>The sensitivity level is selected based on the results of the <a href="#">detection zone test</a>.</p> <p>If during the test the detector doesn't react to break in 5 cases out of 5, the sensitivity should be increased.</p>
External Contact	<p>When the option is enabled, the detector registers alarms of the connected third-party wired detector.</p> <p><a href="#">Learn more</a></p>
Always Active	<p>If active, the detector is always in the armed mode and notifies of alarms.</p> <p><a href="#">Learn more</a></p>
Alert with a siren if an external contact is opened	<p>If active, <a href="#">added sirens</a> are activated in case of an alarm from the third-party detector.</p>
Alert with a siren if glass break detected	<p>When the option is enabled, <a href="#">sirens added to the system</a> are activated if the detector registers breaking of glass.</p>
Chime Settings	<p>If this option is enabled and the system is not armed, opening of the external contact is accompanied by a siren sound.</p> <p>This option applies to the connected third-party detectors with a normally closed (NC) contact type only.</p> <p><a href="#">Learn more</a></p>
Fibra Signal Strength Test	<p>Switches the detector to the Fibra signal strength test mode.</p> <p>The test allows you to check the signal strength between the hub and the detector over the Fibra wired data transfer protocol to determine the optimal installation location.</p>

	<p><a href="#"><u>Learn more</u></a></p>
Detection Zone Test	<p>Switches the detector to the detection zone test mode.</p> <p>The test enables the user to check the detector's reaction to the breaking of glass, operation of a third-party wired detector, and determine the optimal installation location.</p> <p><a href="#"><u>Learn more</u></a></p>
User Guide	<p>Opens GlassProtect Fibra user manual in the Ajax app.</p>
Temporary Deactivation	<p>Allows the user to deactivate the device without removing it from the system.</p> <p>There are three options:</p> <ul style="list-style-type: none"> <li>• <b>No</b> – the device operates in normal mode and transmits all events.</li> <li>• <b>Entirely</b> – the device does not execute system commands and does not participate in scenarios. The system ignores alarms and other notifications from the device.</li> <li>• <b>Lid only</b> – the system will ignore notifications about the triggering of the device tamper.</li> </ul> <p><a href="#"><u>Learn more</u></a></p> <p>The system can also automatically deactivate devices when the set number of alarms is exceeded or when the recovery timer expires.</p> <p><a href="#"><u>Learn more</u></a></p>
Unpair Device	<p>Disconnects the detector from the hub and deletes its settings.</p>



## How to set Chime

**Chime** is a sound signal of Ajax [sirens](#) that indicates triggering of the opening detectors when the system is disarmed. The feature is used, for example, in stores, to notify employees that someone has entered the building.

Chime is set in two stages: setting up opening detectors and setting up sirens. In GlassProtect Fibra, chime only works with the connected normally closed detectors.

[Learn more](#)

### Detector settings

1. Go to the **Devices**  menu.
2. Select GlassProtect Fibra detector.
3. Go to its **Settings** by clicking on the gear icon  in the upper right corner.
4. Go to the **Chime Settings** menu.
5. Select the **If an external contact is opened** option for the detector to notify about opening of the third-party detector.
6. Select the chime sound: 1 to 4 short beeps. Once selected, the Ajax app will play the sound.
7. Click **Back** to save the settings.
8. Set up the siren.

### [How to set up a siren for Chime](#)

## LED indication

LED indication	Event	Note
Lights up green for 1 second.	Turning the detector on.	The detector turns on as soon as the hub feeds power.
Lights up for a couple of seconds until the detector is connected to the hub.	Detector connection to the <a href="#">hub</a> .	
Lights up green for 1 second.	Alarm/tamper triggering.	

Smoothly lights up and goes out (after an alarm or a tamper triggering).	Low detector voltage on the Fibra line.	Voltage of 7 V <sub>DC</sub> or less is considered low.  Check the wired connection of the detector.
--	---	--

## Malfunctions

If a hub identifies a detector fault (for example, there is no connection with the hub via the Fibra protocol), the Ajax app will display a fault counter in the upper left corner of the device icon.

All faults can be seen in the detector states. Fields with malfunctions will be highlighted in red.

### Malfunction is displayed if:

- The detector temperature is out of acceptable limits.
- The detector enclosure is open (tamper is triggered).
- There is no connection with the hub via the Fibra protocol.

## Maintenance

Check the functioning of the detector regularly. The optimal frequency of checks is once every three months. Clean the detector enclosure of dust, cobwebs, and other contaminants as they emerge. Use a soft dry cloth suitable for equipment care.

Do not use substances that contain alcohol, acetone, petrol, and other active solvents to clean the detector.

## Technical specifications

[Learn more](#)

[Compliance with standards](#)



## Complete set

1. GlassProtect Fibra.
2. Installation kit.
3. Quick Start Guide.

## Warranty

Warranty for the Limited Liability Company "Ajax Systems Manufacturing" products is valid for 2 years after the purchase.

If the device does not function correctly, please contact the Ajax Technical Support first. In most cases, technical issues can be resolved remotely.

[Warranty Obligations](#)

[User Agreement](#)

### Contact Technical Support:

- [e-mail](#)
- [Telegram](#)

Subscribe to the newsletter about safe life. No spam

Email

**Subscribe**