

DoorProtect Fibra User Manual

Updated December 6, 2022



DoorProtect Fibra is a bus wired opening detector. Designed for indoor use. Supports connection of a third-party NC detector.



The detector is compatible with [Hub Hybrid \(2G\)](#) and [Hub Hybrid \(4G\)](#). Connection to other [hubs](#), [radio signal range extenders](#), [ocBridge Plus](#), and [uartBridge](#) is not provided. Integration with other security systems is also not provided.

DoorProtect Fibra only works as a part of the Ajax security system, communicating with the hub via the secure Fibra protocol. The wired connection range is up to 2,000 meters when connected via twisted pair U/UTP cat.5.

DoorProtect Fibra is the device of the new Fibra wired product line. Such devices can only be purchased, installed and administered by accredited Ajax partners.

[Buy DoorProtect Fibra](#)

Functional elements

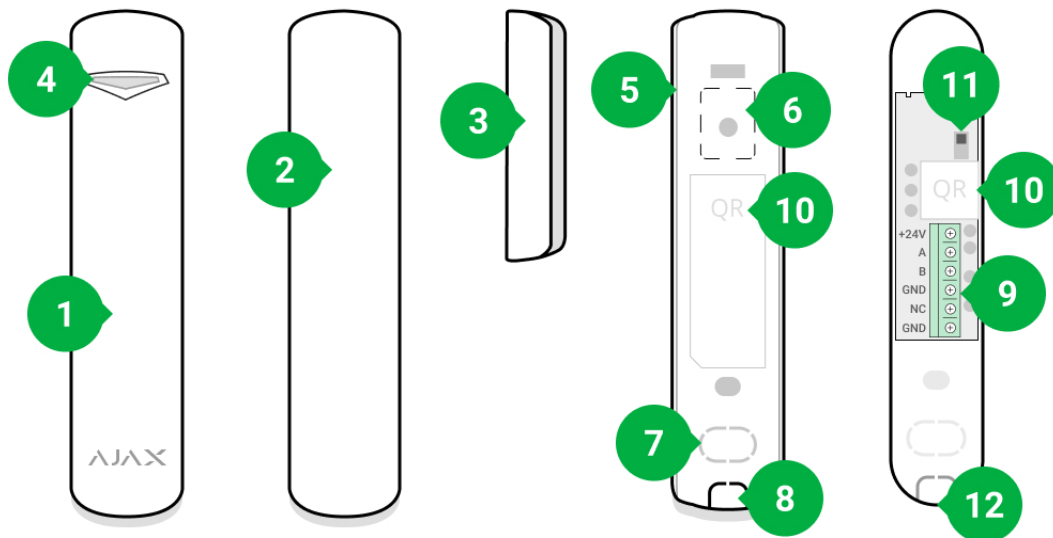

1. DoorProtect Fibra opening detector.
2. Large magnet. Acts up to 2 cm away from the detector.
3. Small magnet. Acts up to 1 cm away from the detector.
4. LED indicator.
5. Rear panel of the detector enclosure. Used as a mount.
6. Perforated part for tamper triggering in case of any attempt to detach the detector from the surface. Do not break it off.
7. Perforated part for routing wires through the wall.
8. Perforated part for routing wires at the bottom of the detector.
9. Terminal block for detector connection.
10. QR code with the device ID. Used to connect to the Ajax security system.
11. Tamper button.
12. Hole for attaching the mounting panel with a screw.

Operating principle

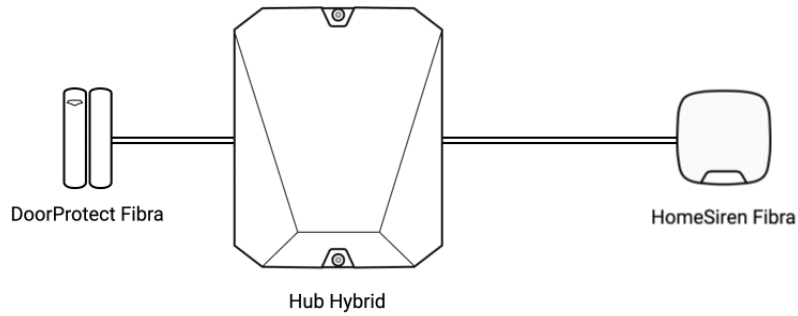

DoorProtect Fibra is a wired opening detector. The detector is connected to the hub via a wired bus and operates using the Fibra protocol. In case of standard installation, it consists of two blocks: a detector and a magnet. The detector is mounted on a frame or fixed part of the structure, and the magnet is mounted on a movable flap or a sliding part.

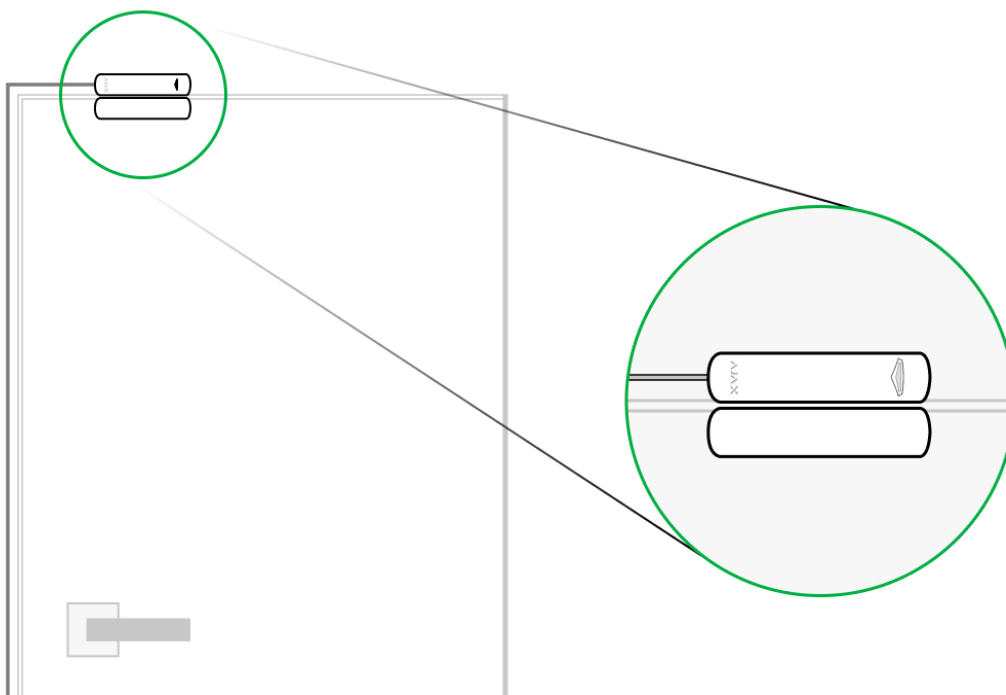

The sensitive element of the detector is a reed switch (**sealed contact**). This is a small flask with an open contact group inside. When a magnet is brought to the detector, a magnetic field is generated and the detector contacts are magnetized, attracted, and closed. Opening the flap or door moves the magnet away from the reed switch, which opens the circuit, and the detector detects opening.

It takes a single magnet for the DoorProtect Fibra detector to create a magnetic field. Use a small or large magnet depending on the conditions at the installation site.

DoorProtect Fibra has two reed switches, which allows you to install a magnet on both the left and right side of the detector. Note that DoorProtect Fibra works with one magnet on one side only. If magnets are installed on both sides, the detector will not detect opening correctly.

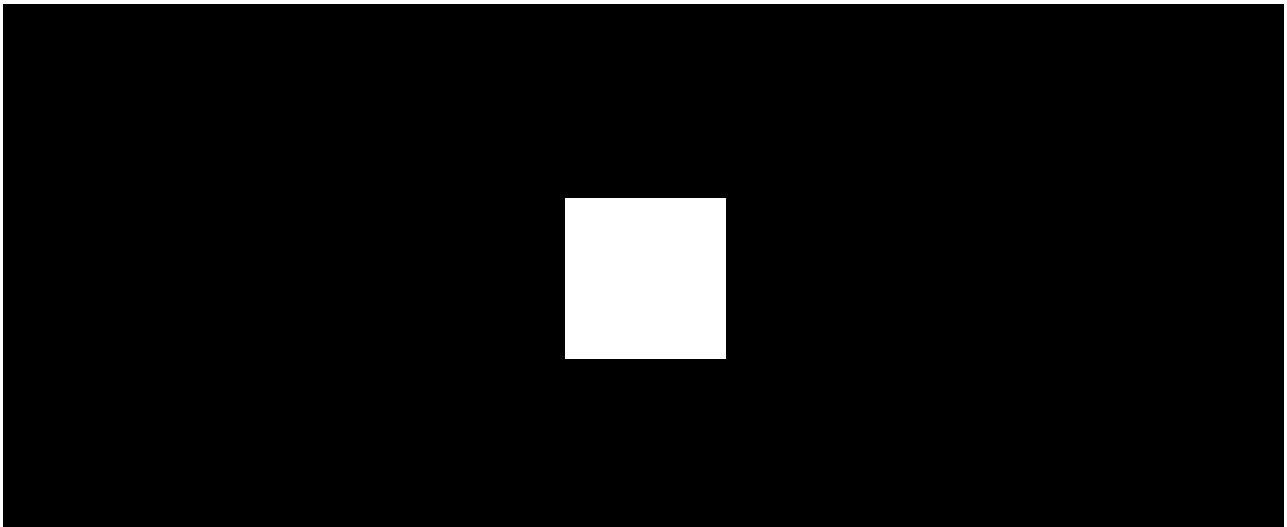

00:00

00:05



A small magnet acts at up to 1 cm, and a large magnet up to 2 cm.

The DoorProtect Fibra detector in the armed mode, when triggered, transmits an alarm signal to the hub in 0.15 seconds, activates the sirens connected to the hub, and notifies the user and the security company.

Users know exactly where motion is detected. The notifications contain the name of the hub (name of the guarded object), the name of the device, and the virtual room to which the detector is assigned.

How Ajax notifies users of alerts

More about Ajax opening detectors



The detector doesn't go into armed mode instantly. The time it takes to switch to armed mode depends on two factors: exit delays (specified in the **detector settings**) and the hub – detector ping interval (Fibra settings, the default value is 36 seconds). In the first case, the delay is set by an administrator or a PRO-user with administrator rights. In the

second case, the delay occurs because it takes one ping interval for the hub to notify the detector about the transition to armed mode.

Fibra data transfer protocol

The detector uses Fibra technology to transmit alarms and events. This is a two-way wired data transfer protocol that provides fast and reliable communication between the hub and the rest of the devices. Using the bus connection method, Fibra delivers alarms and events instantly, even if 100 detectors are connected to the system.

Fibra supports block encryption with a floating key and device authentication at every communication session to prevent sabotage and device spoofing. The protocol provides for regular polls of detectors by the hub at intervals of 12 to 300 seconds to monitor communication with all devices and display their statuses in real-time in Ajax apps.

[Learn more about Fibra protocol \(in progress\)](#)

Connecting a third-party wired detector

A third-party wired NC detector (normally closed, or NC detector) can be connected to DoorProtect Fibra. It can be any type of detector: motion, opening, or vibration.

DoorProtect Fibra cannot power a third-party detector. It should be connected separately. For the type and voltage of the third-party detector, refer to the device documentation or contact the manufacturer's technical support.

[How to connect a wired detector to DoorProtect Fibra \(in progress\)](#)

Sending events to the monitoring station

The Ajax security system transmits events to [Ajax PRO Desktop](#) or a Central Monitoring Station (CMS) in the formats of **SurGard (Contact ID)**, **SIA (DC-09)**, **ADEMCO 685**, and other proprietary protocols. A complete list of supported protocols is [available here](#).

Types of DoorProtect Fibra events that are transmitted to PRO Desktop and the CMS:

1. Primary detector alarm.
2. Third-party NC detector alarm.
3. Tamper alarm/recovery.
4. Loss/recovery of connection between the detector and the hub.
5. Temporary deactivation / activation of the detector.
6. Unsuccessful attempt to arm the security system (with integrity check enabled).

When an alarm is received, the operator of the security company monitoring station knows exactly what happened and precisely where to send a fast response team on the site. Addressability of each Ajax device allows you to send not only events to the PRO Desktop or to the CMS but also the type of the device, the name of the device, and the virtual room to which the detector is assigned. Note that the list of transmitted parameters may differ depending on the type of CMS and the selected protocol for communication with the monitoring station.



The device ID, the loop (zone) number, and the bus number can be found in its states in the Ajax app.

Selection of the installation site for the detector

When choosing where to place the detector, consider the parameters that affect its normal operation: Fibra signal strength, length of the cable for connecting the detector, and the opening detection zone.

Consider the placement recommendations when designing your facility's security system. Design and installation of the security system should be carried out by professionals. A list of authorized official Ajax partners is available here.

Design and preparation

For the system to work correctly, it is important to properly design the project and install all devices correctly. Failure to follow the basic installation rules and recommendations of this manual may result in detector malfunction, false alarms, or loss of connection with already installed devices.

When designing the layout scheme of the detectors, consider the wiring diagram of the power cables laid on the site. Signal cables must be laid at a distance of at least 50 cm from the power cables when lying parallel, and, if they intersect, it must be at a 90° angle. Detectors are connected in sequence if you connect multiple devices on the same bus.



The maximum number of connectable devices for the Hub Hybrid is 100 at the default settings.

[How to calculate the number of connectable detectors \(in progress\)](#)

For facilities that are under construction or renovation, cables are laid after the main wiring of the facility. Use protective tubes to organize and secure the cables; ties, clips, and staples can be used to anchor them.

When laying cables externally (without mounting them inside the walls), use an electric channel raceway. Raceways should be no more than half-filled with cables. Do not allow cables to sag. The raceway should be hidden from view if possible – for example, behind furniture.





We recommend laying cables inside walls, floors, and ceilings. This will provide greater security; the cables will not be visible, and it will be impossible for an intruder to access them.

When selecting a cable, consider the length of the connection lines and the number of detectors to be connected; these parameters affect the signal strength. We recommend using shielded copper cables with a high-quality insulation layer.

Observe the bend radius when installing. It is specified by the manufacturer in the cable specifications. Otherwise, you risk damaging or breaking the conductor.

Be sure to check all cables for bends and physical damage before installation. Perform the installation in a way that minimizes the possibility of damage to the cables from the outside.

Signal strength and cable length

The Fibra signal level is determined by the number of undelivered or corrupted data packages over a certain period. The icon  on the **Devices**  tab indicates the signal strength:

- **Three bars** – excellent signal strength.
- **Two bars** – good signal strength.
- **One bar** – low signal strength, stable operation is not guaranteed.
- **Crossed out icon** – no signal.

The signal strength is influenced by the following factors: the number of devices connected to one bus, the length and type of cable, and the proper connection of the wires to terminals.



Check the Fibra signal strength before final installation of the detector. With a signal strength of one or zero bars, we do not guarantee stable operation of the device.

The permissible cable length depends on its type, material, and the method of connecting the detectors. When connected via the **Beam connection (Radial wiring)** using the U/UTP cat.5 (4×2×0.51) twisted pair, the wired connection length can reach up to 2,000 meters.

When devices are connected via the **Ring connection method**, the maximum cable length is 500 meters in case of using a twisted pair.

[How to calculate the wire connection length \(in progress\)](#)



Connecting devices using the **Ring connection method** will be available with future OS Malevich updates. Hardware update of Hub Hybrid won't be required.

[How OS Malevich updates](#)

Detection zone

When choosing where to place the detector, conduct a [Detection Zone Test](#) to verify the operation of the device and to ensure that the detector responds correctly to opening and closing of a door or a window.

Do not install the detector

1. Outdoors. This can lead to false alarms and detector failure.
2. With two magnets at a time. The detector recognizes only one magnet on one side of the detector – left or right.
3. Inside premises with temperature and humidity outside the permissible limits. This could damage the detector.



Do not install DoorProtect Fibra with two magnets at a time. The detector recognizes only one magnet on one side – left or right.

Installation and connection



Before installing DoorProtect Fibra, make sure that you have selected the optimal location and that it meets the conditions of this manual. Cables must be hidden from view and located in a place that is difficult for intruders to access to reduce the likelihood of sabotage. Ideally, mount them in the walls, floor, or ceiling. Before the final installation, conduct tests of the [detection zone](#) and the [Fibra signal strength](#).

DoorProtect Fibra is connected with a 4-core cable: two cores for powering the device (+24V and GND) and two cores for data transmission (line A and line B).

When connecting to the detector terminals, do not twist the wires together; solder them. The ends of the wires that will be inserted into the detector terminals should be tinned or crimped with special tips. This will ensure a reliable connection. **Follow safety procedures and regulations for electrical installation work.**

How to calculate the wire connection length (in progress)

In order to mount a detector:

1. Turn off the hub. Disconnect the external power supply and the backup battery.

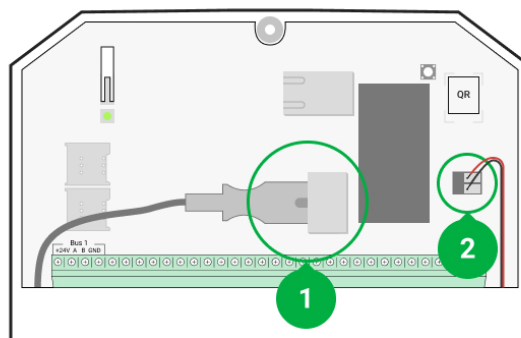

1 – External power supply

2 – Backup battery

2. Plug the detector connection cable into the hub casing and connect the wires to the bus terminals.

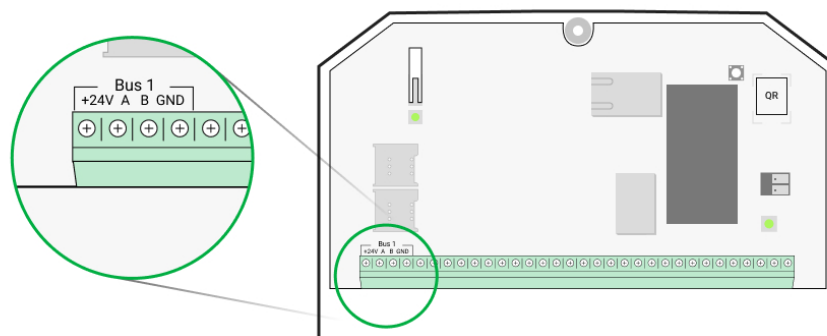

+24V – power supply input

A, B – signal terminals

GND – ground

3. Remove the rear panel of the detector and gently break out the perforated part to lead the cable out.

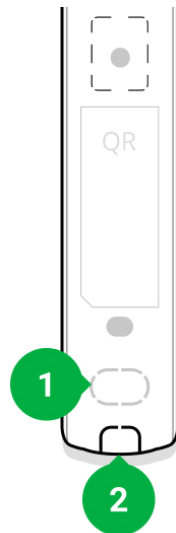

4. Run the cable from the hub into the detector enclosure through the hole made.
5. Connect the wires to the terminals according to the scheme below. Follow the polarity and connection order of the wires. Securely fasten the cable to the terminals.

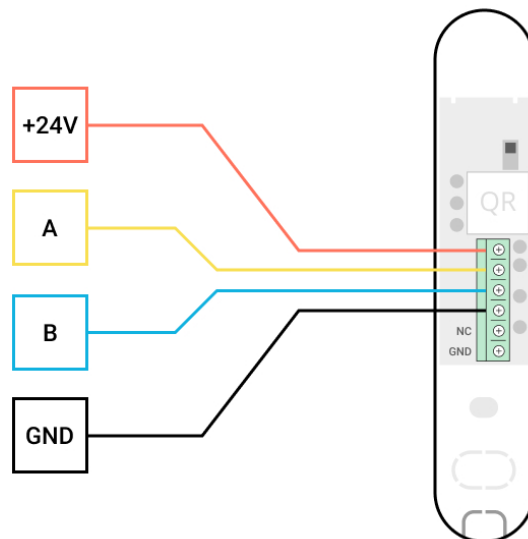

+24V – power supply input
A, B – signal terminals
GND – ground

6. If the detector is not the last one in the connection line, prepare a second cable in advance. The ends of the wires of the first and second cables,

which will be inserted into the detector terminals, must be tinned and soldered together, or crimped with special tips.

7. If the detector is the last one in the line and the **Beam connection (Radial wiring)** is used, install a terminating resistor by connecting it to the signal terminals of the device. When the **Ring connection method** is used, a terminating resistor is not needed.

More about detector connection methods (in progress)



We recommend using the **Ring connection method** (hub – device – hub). If the ring is broken, not a single device will be disabled. In this case, two beams are formed, which will continue to operate normally and transmit events to the hub. If the ring is broken, the users and security company receive notification.



8. Temporarily secure the detector to a window or door frame using double-sided tape or other temporary fasteners at the chosen installation place. This is needed to test the detector.
9. Temporarily secure the magnet.
10. Turn on the hub to supply the connected detector with power. When power is applied, a detector LED will notify that the power is turned on.
11. Add a detector to the system.
12. Conduct the Signal Strength Test. The recommended signal strength value is two or three bars. Otherwise, check the connection and the condition of the cable.
13. Run a Detection Zone Test. To check the detector, open and close the window where the device is installed. If during the test the detector fails to respond to triggering in 5 cases out of 5, change the place or method of installation. The magnet may be too far from the detector.

14. If the detector passes the tests, fix the detector with the bundled screws using two fixation points (one is in the perforated part of the panel, above the tamper). When using other fasteners, make sure they do not damage or deform the mounting panel.



Double-sided tape can only be used for temporary installation. The device attached by the tape may come unstuck from the surface at any time. As long as the device is taped, the tamper will not be triggered when the device is detached from the surface.

Connecting a third-party wired detector

You can connect a wired NC detector (normally closed, or NC detector) of any type (motion, opening, vibration) to DoorProtect Fibra using terminals.

DoorProtect Fibra does not power a third-party detector. It should be connected separately. For the type and voltage of the third-party detector, refer to the device documentation or contact the manufacturer's support service.

Install a third-party detector at the distance no more than 1 meter away from DoorProtect Fibra. Increasing the length of the wire degrades the quality of communication between devices.

To connect a third-party wired detector:

1. Disconnect the external power and the hub's backup battery.
2. Remove the front panel of DoorProtect Fibra.
3. Run the cable of the third-party wired detector into the DoorProtect Fibra enclosure.
4. Connect the wired detector to the DoorProtect Fibra terminals.

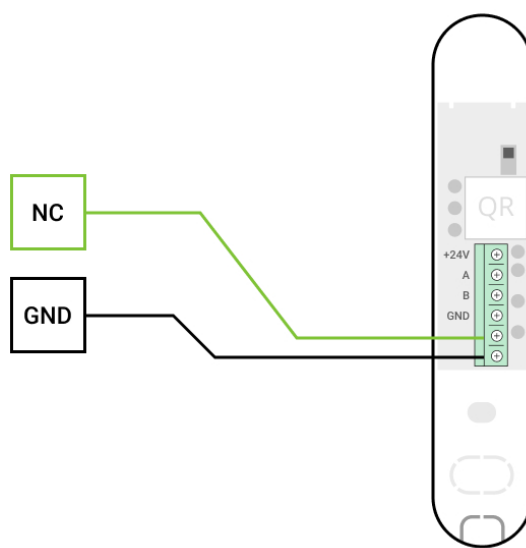

NC – connection terminal

GND – ground

5. Turn on the hub.
6. In the **DoorProtect Fibra settings**, enable the **External contact** option.
7. Check the operation of the connected wired detector.

Adding to the system



The detector is only compatible with Hub Hybrid (2G) and Hub Hybrid (4G). Adding and configuring Fibra devices is only possible through the Ajax PRO app by a user with administrator rights.

[Types of accounts and their rights](#)

Before adding a device

1. Install the [PRO version of the app](#). Log in to a [PRO account](#) or create a new one if you don't have it yet. Add a detector-compatible hub to the app, set the necessary settings, and create at least one [virtual room](#).
2. Turn on the hub and make sure it has access to the Internet: via Ethernet and/or mobile network. You can do this in the Ajax app or by checking the LED on the hub board: it should light up white or green.
3. Make sure the hub is disarmed and does not start updates by checking its status in the Ajax app.

4. Make sure the detector is physically connected to the hub.

How to add DoorProtect Fibra

There are two ways to add devices: manually and automatically.

To add a detector manually:

1. Open the PRO version of the app. Select the hub you want to add DoorProtect Fibra to.
2. Go to the **Devices**  tab and click **Add device**.
3. Name the detector, scan or type in the QR code (placed on the detector body and the packaging), select a room and a group (if the group mode is enabled).
4. Click **Add**.

To have the detector added automatically:

1. Open the PRO version of the app. Select the hub you want to add DoorProtect Fibra to.
2. Go to the **Devices**  tab and click **Add device**.
3. Select **Add Bus Devices**. After scanning, a list of all devices physically connected to the hub, which have not yet been added to the system, will be displayed on the screen. The devices are sorted by the buses they are physically connected to.

After scanning the buses, the detectors will be displayed in the **Devices**  tab. The order of the devices will depend on which bus they are connected to.

By default, the device name includes the detector name and its identifier. To connect detectors to a hub, edit their name, and assign a room and a group to the device (if the group mode is activated in the hub settings).

To check which specific detector you want to add, we have provided two methods: LED indication and detector triggering.

Method 1: Via LED indication.

In the list of available devices to add, click on any option. The LED of this detector will start blinking after you press it. This way, you'll know exactly which detector you're adding, how to name it, and which room and group it should be assigned to.

To add a detector:

1. Click on the device in the list.
2. Create a name.
3. Specify the room and the security group (if enabled).
4. Click **Save**.

If the detector is connected to the hub successfully, it will disappear from the list of available detectors.

Method 2: By detector alarm.

Enable the **Add Detectors by Alarm** option above the list of detectors.

Prompt an alarm by opening the door or window the detector protects. When triggered, the detector will move to the top of the list to the **Recently triggered devices** category. The detector will stay in this category for 5 seconds, after which it will be moved back to the bus category.

To add a detector:

1. Click on the device in the list.
2. Create a name.
3. Specify the room and the security group (if enabled).
4. Click **Save**.

If the detector connects to the hub successfully, it will disappear from the list of available detectors.



Device status updates in the list depend on the Fibra settings; the default value is 36 seconds.

If the connection fails, check the accuracy of the wired connection and try again. If hub already has the maximum number of devices added (for Hub Hybrid, the default is 100), you will get an error notification when you add one.

DoorProtect Fibra only works with one hub. When connected to a new hub, the detector stops exchanging commands with the old one. Once added to a new hub, DoorProtect Fibra is not removed from the list of devices of the old hub. This must be done through the Ajax app.

Malfunctions

When a detector identifies a fault (for example, there is no connection via the Fibra protocol), the Ajax app displays a malfunction counter in the upper left corner of the device icon.



All faults can be seen in the detector states. Fields with malfunctions will be highlighted in red.







Malfunction is displayed if:

- The detector temperature is out of acceptable limits.
- The detector enclosure is open (tamper is triggered).
- There is no connection with the hub via the Fibra protocol.

Icons

The icons display some of DoorProtect Fibra states. You can view them in the Ajax app on the **Devices**  tab.

Icon	Meaning
	Fibra signal strength, displays the signal strength between the hub and the detector. Learn more
	The detector operates in the Always Active mode. Learn more

 	<p>Entry and/or exit delay is enabled.</p> <p>Learn more</p>
	<p>DoorProtect Fibra will work when the Night Mode is enabled.</p> <p>Learn more</p>
	<p>DoorProtect Fibra has detected opening of a door or window. The icon is displayed regardless of the security mode.</p>
	<p>The external contact of the DoorProtect Fibra detector is on.</p> <p>Learn more (in progress)</p>
	<p>DoorProtect Fibra has been temporarily disabled.</p> <p>Learn more</p>
	<p>DoorProtect Fibra has been deactivated due to exceeding the number of alarms.</p> <p>Learn more</p>
	<p>DoorProtect Fibra has been disabled by timer.</p> <p>Learn more (in progress)</p>
	<p>DoorProtect Fibra has tamper triggering events temporarily deactivated by a user or PRO with administrator rights.</p> <p>Learn more</p>

States

The states include information about the device and its operating parameters. DoorProtect Fibra states can be found in the Ajax app:

1. Go to the **Devices**  tab.

2. Choose DoorProtect Fibra from the list.

Parameter	Meaning
Temperature	<p>Detector temperature – it is measured on the processor and changes gradually.</p> <p>Acceptable measurement error between the value in the app and the room temperature: 2–4°C.</p> <p>The value is updated as soon as the detector identifies a temperature change of at least 1°C.</p>
Fibra Signal Strength	<p>Signal strength between the hub and DoorProtect Fibra. Recommended values – 2–3 bars.</p> <p>Fibra – protocol for transmitting DoorProtect Fibra events and alarms.</p> <p><u>Learn more</u></p>
Connection via Fibra	<p>Status of the connection between the hub and the detector:</p> <ul style="list-style-type: none">• Online – the detector is connected to the hub.• Offline – the detector is not connected to the hub. Check the detector connection to the bus.
Bus Voltage	<p>Total bus voltage:</p> <p>Low value – 7 V</p> <p>Maximum allowable value – XX V</p>
Lid	<p>The status of the detector tampers that respond to detachment or violation of the integrity of the enclosure:</p> <ul style="list-style-type: none">• Open – at least one of the enclosure panels is open.• Closed – both enclosure panels are closed (the detector is completely closed).



	<p>When the DoorProtect Fibra front panel is opened, the following event is sent: “Front lid of detector %detector name% is open”.</p> <p>When the detector is detached, the following event is sent: “Detector %detector name% is detached from the mount”.</p> <p>Learn more</p>
<p>Delay When Entering, sec</p>	<p>Delay time when entering (5 to 120 seconds).</p> <p>Delay when entering (alarm activation delay) is the time the user has to disarm the security system after entering the secured area.</p> <p>Learn more</p>
<p>Delay When Leaving, sec</p>	<p>Delay time when leaving (5 to 120 seconds).</p> <p>Delay when leaving (arming delay) is the time the user has to leave the secured area after arming.</p> <p>Learn more</p>
<p>Delay when entering for the Night mode, sec</p>	<p>Delay time when entering in the Night mode.</p> <p>Delay when entering (alarm activation delay) is the time the user has to disarm the security system after entering the premises.</p> <p>Learn more</p>
<p>Delay when leaving for the Night mode, sec</p>	<p>Delay time when leaving in the Night mode.</p> <p>Delay when leaving (arming delay) is the time the user has to leave the premises after arming.</p> <p>Learn more</p>
<p>Primary Detector</p>	<p>Primary detector state:</p> <ul style="list-style-type: none"> • Disabled – primary contact is disabled.

	<ul style="list-style-type: none"> • Open – primary contact is open. • Closed – primary contact is closed.
External Contact	<p>State of the external detector connected to DoorProtect Fibra:</p> <ul style="list-style-type: none"> • Disabled – the external contact is disabled (the option is disabled in the app). • Open – the external contact is connected and in the open state. • Closed – the external contact is connected and in the closed state.
Always Active	<p>When this option is enabled, the detector is constantly in the armed mode and reports opening of the door or window on which it is installed.</p> <p><u>Learn more</u></p>
Temporary Deactivation	<p>Shows the status of the device temporary deactivation function:</p> <ul style="list-style-type: none"> • No – the device operates normally and transmits all events. • Lid only – the hub administrator has disabled notifications about triggering on the device body. • Entirely – the hub administrator has excluded the detector from the system. The device does not execute system commands and does not report alarms or other events. The option is configured in the Ajax PRO app. • By the number of alarms – the device is automatically disabled due to the excess number of alarms. • By timer – the device is automatically turned off by the system after the recovery time expires. The option is configured in the Ajax PRO app.

	Learn more
Firmware	Detector firmware version.
Device ID	Detector ID – Also available on the detector enclosure and the packaging.
Device №	Device number. This number is transmitted to the CMS in case of an alarm or event.
Bus №	The number of the hub bus the device is physically connected to.

Settings

To change the detector settings in the Ajax app:

1. Go to the **Devices**  tab.
2. Choose DoorProtect Fibra from the list.
3. Go to **Settings** by clicking on the gear icon .
4. Set the required parameters.
5. Click **Back** to save the new settings.

Settings	Meaning
Name	<p>Detector name. Displayed in the list of hub devices, SMS text, and notifications in the event feed.</p> <p>To change the detector name, click on the pencil icon .</p> <p>The name can contain up to 12 Cyrillic characters or up to 24 Latin characters.</p>
Room	<p>Selecting the virtual room to which DoorProtect Fibra is assigned.</p> <p>The room name is displayed in the text of SMS and notifications in the event feed.</p>
Delay When Entering, sec	Selecting the delay time when entering.

	<p>Delay when entering (alarm activation delay) is the time the user has to disarm the security system after entering the premises.</p> <p><u>What Is Delay When Entering</u></p>
Delay When Leaving, sec	<p>Selecting the delay time when leaving.</p> <p>Delay when leaving (arming delay) is the time the user has to leave the premises after arming.</p> <p><u>What Is Delay When Leaving</u></p>
Delays in Night Mode	<p>When this option is enabled, the set entry/exit delays also work in the Night mode.</p> <p><u>What is Night mode</u> <u>What Is Delay When Leaving</u></p>
Arm in Night Mode	<p>When this option is enabled, the detector will enter the armed mode when using the Night mode.</p> <p><u>What is Night mode</u></p>
Alarm LED indication	<p>Controls the flashing of the detector LED in case of alarm and tamper triggering:</p> <ul style="list-style-type: none"> • Option enabled – the indication is enabled. • Option disabled – the indication is disabled and will not report alarm and tamper triggering.
Primary Detector	<p>When this option is enabled, the primary DoorProtect Fibra detector reacts to opening and closing.</p>
External Contact	<p>When this option is enabled, DoorProtect Fibra logs alarms by an external detector.</p>
Always Active	<p>When this option is enabled, the detector is constantly in the armed mode and detects opening of the door or window on which it is installed.</p>

	<p>Learn more</p>
Activate siren if a door or window is open	<p>When this option is enabled, the sirens connected to the system are activated when a door or window is opened.</p>
Activate siren if an external contact is open	<p>When this option is enabled, the sirens connected to the system are activated in case of an alarm from an external detector.</p>
Chime Settings	<p>When this option is enabled and the system is not armed, when opening, the detector alerts by the sound signal of sirens.</p> <p>Learn more</p>
Fibra Signal Strength Test	<p>Switches the detector to the Fibra signal strength test mode.</p> <p>The test allows you to check the signal strength between the hub and the detector over the Fibra wired data transfer protocol to determine the optimal installation location.</p> <p>Learn more</p>
Detection Zone Test	<p>Switches the detector to the detection zone test mode.</p> <p>The test enables the user to check the detector's reaction to the movement and determine the optimal installation location.</p> <p>Learn more</p>
User Guide	<p>Opens the User Manual of DoorProtect Fibra detector in the Ajax app.</p>
Temporary Deactivation	<p>Allows to disable the device without removing it from the system.</p> <p>Three options are available:</p> <ul style="list-style-type: none"> • No – the device operates normally and transmits all events. • Entirely – the device will not execute system commands or participate in

	<p>scenarios, and the system will ignore device alarms and other notifications.</p> <ul style="list-style-type: none"> • Lid only – the system will ignore notifications about the tamper triggering. <p><u>Learn more</u></p> <p>The system can also automatically deactivate devices when the set number of alarms is exceeded or when the recovery time expires.</p> <p><u>Learn more</u></p>
Unpair Device	Disconnects the detector from the hub and deletes its settings.



How to set up chime

Chime is a sound signal of [Ajax sirens](#) that indicates triggering of the opening detectors when the system is disarmed. The function is used, for example, in stores to notify employees that a visitor has entered the premises.

Chime is configured in two stages: setting up opening detectors and setting up sirens.

Learn more

Detectors settings

1. Go to the **Devices**  menu.
2. Select the DoorProtect Fibra detector.
3. Go to its **Settings** by clicking the gear icon  in the upper right corner.
4. Go to the **Chime settings** menu.
5. Select the events to be notified by the siren:
 - If a door or a window is open.

- If an external contact is open (available if the External Contact option is enabled).
6. Select the notification sound: 1 to 4 short beeps. Once selected, the Ajax app will play the sound.
 7. Click **Back** to save the settings.
 8. Set up the required siren.

How to set up a siren for Chime

Indication

Indication	Event	Note
Lights up green for 1 second.	Turning the detector on.	The detector turns on as soon as the hub feeds power.
Lights up for a couple of seconds until the detector is connected to the hub.	Connecting the detector to the hub.	
Lights up green for 1 second.	Alarm / tamper triggering.	
Lights up slowly – goes out slowly. (after alarm or tamper triggering).	Low bus voltage.	Voltage of 7 V or less is considered low. Check the wired connection of the detector.

Functionality testing

The Ajax security system provides several types of tests that help you make sure that installation points of devices are selected correctly. DoorProtect Fibra tests do not start straight away but no later than over a single hub-detector ping period (36 seconds with a default hub settings). You can change the ping period of devices in the **Fibra** menu of the hub settings.

To run a test in the Ajax app:

1. Select the hub.

2. Go to the **Devices**  menu.

3. Choose DoorProtect Fibra.

4. Go to **Settings** .

5. Select a test:

- Fibra Signal Strength Test.
- Detection zone.

6. Launch and conduct a test.

Maintenance

Check the functioning of the detector on a regular basis. The optimal frequency of checks is once every three months. Clean the detector enclosure from dust, cobwebs, and other contaminants as they emerge. Use a soft dry cloth suitable for equipment care.

Do not use substances that contain alcohol, acetone, gasoline, or other active solvents to clean the detector. Wipe the lens gently as scratches may impair the detector sensitivity.

Technical specifications

[Learn more](#)

[Compliance with standards](#)

Complete set

1. DoorProtect Fibra.
2. Large magnet.
3. Small magnet.
4. Installation kit.

Warranty

Warranty for the AJAX SYSTEMS MANUFACTURING Limited Liability Company products is valid for 2 years after the purchase.

If the device does not function correctly, please contact the Ajax Technical Support first. In most cases, technical issues can be resolved remotely.

[Warranty obligations](#)

[User Agreement](#)

Contact Technical Support:

- [e-mail](#)
- [Telegram](#)

Subscribe to the newsletter about safe life. No spam

Email

Subscribe